

LED Preset Counters – Type 572

Position- and Difference Display

 24/17... 30 V	 DIN 48 x 96	 IP 65	 max. 1 MHz	 Operation with gloves	 TTL, HTL and RS422-Input	 6/8 LEDs	 DC OUT 5/24V	 mA, V	 4 Transistor- Output	 RS232
Supply voltage AC/DC	DIN front panel	High IP value	High frequency	Operation with gloves	TTL, HTL and RS422-Input	6/8 LEDs	2 x Sensor supply	Output	Transistor-Output	Interface

Innovative:

- 2 separate freely scalable count inputs - HTL or TTL; Both also with inverted inputs, max. input frequency 1 MHz/ channel
- Very bright LED display 15 mm high (6 digit) and 10 mm high (8 digit)
- 4 freely programmable fast solid-state outputs, each with 350 mA output current
- Step or tracking preset
- Simple programming – with function codes, dependent on the operating mode selected
- With 8 different permanent count functions, such as simple count, difference count and total count of both inputs, batch counters etc.



Compact:

- Up to 3 display values in a single device, Display Counter 1, Display Counter 2 as well as the display calculated from Counter 1 and 2
- AC and DC supply voltages in one device
- Simple programming with 4 keys, all keys can be assigned dual programming functions.
- 4 fast solid-state outputs

Versatile:

- Can be used as a counter or position display with limit values
- Monitoring function, where 2 values are monitored or calculated with respect to each other
- 4 fast programmable inputs with various functions such as reset, gate, display memory, reference input or switching between the display values.
- Scalable analogue outputs 0/4 ... 20 mA, +/-10 V or 0 ... 10 V
- 2 auxiliary power supplies for sensors: 5.2 V DC and 24 V DC
- Standard interface RS 232
 - for parameter setting
 - for reading out the values to a PC or PLC
 - for modifications during operation

Application examples:

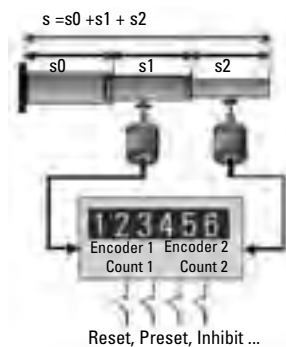

Total-Position display

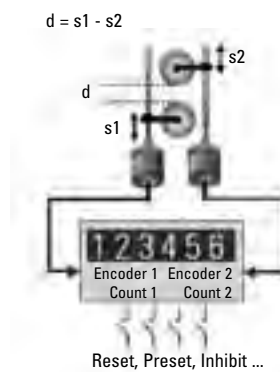

Difference-Position display

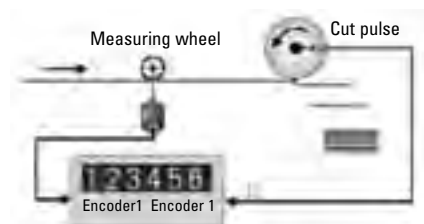

Measurement of the effective cut amount

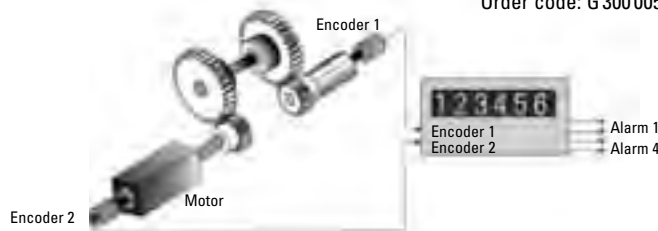

Monitoring of torsion, shafts or gear breakage

OS2 software for parameter setting can be downloaded at www.kuebler.com

Counter series for demanding applications, with two individually scalable encoder inputs, in each case A, \bar{A} , B, \bar{B} for count frequencies up to 1 MHz per channel. Operating modes can be selected for position or event counter, total counter, difference counter, cut-to-length display, diameter calculator and more.



Accessories for DIN rail mount
Order code: G 300 005

LED Preset Counters – Type 572

Supply voltage:-	24 V AC, ± 10%
	24 (17 ... 30) V DC
Current consumption [DC]:	100 mA + Current consumption encoder
Connected load [AC]:	15 VA
Auxiliary power supply	2 x 5,2 V DC, each 150 mA
output for sensors:	2 x 24 V DC, each 120 mA
Display:	15 mm high LED-Display, 6 digit
	10 mm high LED-Display, 8 digit
Inputs:	2 universal incremental encoder inputs
Count frequency:	RS422 and TTL with inv. 1 MHz
	HTL asymmetric 200 kHz
	TTL asymmetric 200 kHz
	(per encoder)
Control inputs:	4 control inputs HTL, Ri = 3,3kOhm
	low < 2,5 V, high > 10V,
	min. pulse duration 50 µs

Switch outputs:	4 fast power transistors 5 ... 30 V DC
	350 mA, reaction time < 1ms*, inductive loads require a freewheeling diode
Serial interface:	RS232, 2400 ... 38400 Baud
Analogue outputs:	0/4 ... 20 mA, load max. 270 Ohm
	0 ... ±10 V (max. 2 mA)
	Resolution 14 Bit, precision 0,1 %
	reaction time < 1 ms
Ambient temperature:	0 ... 45 °C [32 ... 113 °F]
Storage temperature:	-25 ... +70 °C [-13 ... 158 °F]
Housing:	Noryl UL94-V-0
Protection class:	IP65 (front side)
Screw terminal:	Cable cross-section max. 1,5 mm ²
Conformity and norms:	EMV 89/336/EWG: EN 61 000-6-2
	EN 61 000-6-3
	NS73/23/EWG EN 61010-1
Weight:	ca. 250 g

*Intensive serial communication can temporarily prolong the reaction time

Dimensions:

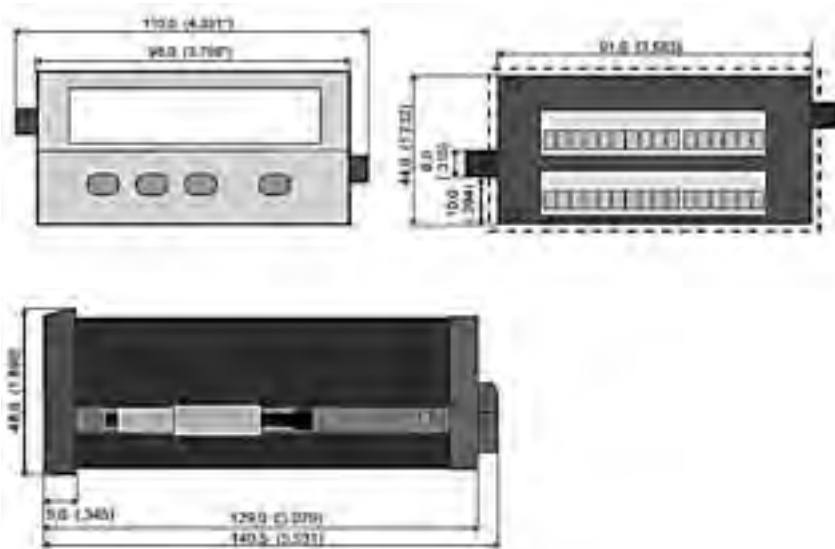

Electrical connections:

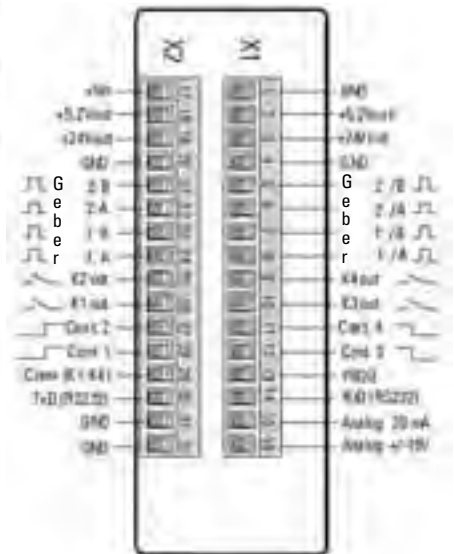

Application examples:

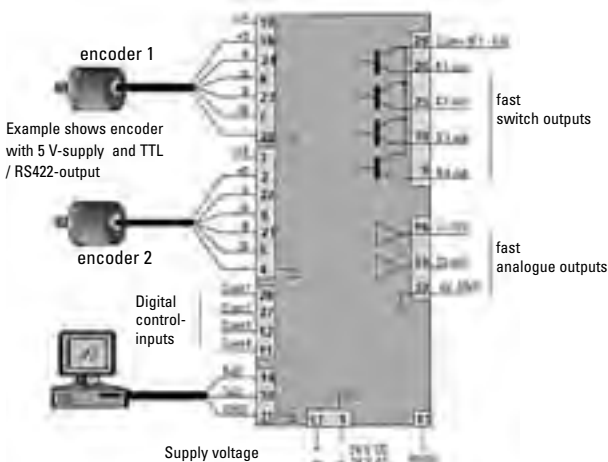

Order code specification:

Position display, 6 digits, with 4 fast switch outputs and serial interface:

6.572.0116.D05

Position display, 6 digits, with 4 fast switch outputs and serial interface and scalable analogue outputs:

6.572.0116.D95

Position display, 8 digits, with 4 fast switch outputs and serial interface:

6.572.0118.D05

Position display, 8 digits, with 4 fast switch outputs and serial interface and scalable analogue output:

6.572.0118.D95

Delivery contents:

- Controller 572
- Gasket, fastening set
- Instruction manual German/English