



NIPRESS

PRESSURE TRANSMITTERS



OUR PROFESSION IS YOUR LEVEL

GENERAL

NIPRESS pressure transmitters working in 2- or 3-wire systems convert pressure (input signal) to direct current or voltage (output signal) proportional with the pressure. The wide choice of models provides possibility to complete almost all relative or absolute pressure measurement tasks requiring different accuracy. Their design, high overload capability and the possibility to install the units in any physical position allows for a wide range of industrial applications.

D-200 series featuring capacitance ceramics transducer is applicable to the measurement of normal or corrosive mediums such as gases, fumes or liquids but not suggested for materials tending to sedimentation, crystallisation or stiffening. These units are suitable to measure overpressure.

D-300 series with piezoresistive transducer and stainless steel diaphragm is also suitable to dynamic pressure changes. It is not recommended to liquids tending to sedimentation, crystallisation and solidification. Absolute pressure measurement is feasible at ranges over 0.1 bar. Transmitters are available for use in 2- or 3-wire systems with standard 4 ... 20 mA or 0 ... 10 V DC outputs.

D-400 series with piezoresistive or ceramic transducer behind its flush face diaphragm is especially suitable to contaminated liquids and for tanks with bottom measurement of pressure (level). The high temperature versions are able to be used up to 150 °C. Units in the pressure range of 0 ... 40 bar operate up to 300 °C. Absolute pressure measurement in the range of over 0.1 bar is possible.

The standard pressure transmitting liquid of the sensors is silicone oil, but the units can also be ordered with a pressure transferring liquid suitable for food industry. Transmitters can be applied both in 2- and 3-wire systems.

Loop powered models of the D-300 and D-400 series have Ex versions too.

All transmitters can be equipped with the loop powered, programmable, plug in display **PLK-501** to be ordered separately.

APPLICATION

Due to its small size and weight NIPRESS can directly be installed on tanks, pipes, machines, etc.

For pressure measurement of mediums with temperatures over 75 °C use of condensing device is suggested or high temperature version should be applied.

Ceramic sensors are to be protected against possible pressure shocks with some kind of damping device such as throttle disc or partly closed valve. Measuring small pressures in systems with substantial height difference between the pressure transmitter and the place of measurement the hydrostatic pressure prevailing in the impulse tube must not be forgotten. Transmitter used for level measurement can be screwed in a stub on the wall or bottom of the tank. To avoid problems caused by moisture getting to the electric connections in open air applications the use of unit with integral cable, or a protection shield is recommended and the fastening bolt of the plug in connector should be tightened properly.

TECHNICAL DATA

TYPE	D□□-2□□-2	D□□-3□□-□	D□□-4□□-□
Range	0 ... 400 bar	-1 ... 600 bar	-1 ... 400 bar
Overload capability	According to the order code		
Accuracy	0,25 % or 0,5 % According to the order code	P > 0.4 bar 0.25 or 0.5% According to the order code P ≤ 0.4 bar 0,5%	
Medium temperature	- 25...+125 °C	- 25...+125 °C	- 25...+125 °C High temp.: max. 300 °C
Ambient temperature	- 25...+85 °C		
Transducer type	Capacitance	Piezoresistive	Piezoresistive, over 40 bar: capacitance
Wetted parts	Sensor	Aluminium oxid ceramics (inner diaphragm)	Stainless steel: DIN 1.4435 (inner diaphragm)
	Sensor sealing	FKM (Viton) < P100 bar ≥ NBR	FKM (Viton) ≤ P 40 bar > NBR
	Connection	Stainless steel: DIN 1.4305	Stainless steel: DIN 1.4571
	Housing	Stainless steel: DIN 1.4305	Stainless steel: DIN 1.4301
Output	4...20 mA	4...20 mA; 0...10 V	
Power supply	12...36 V DC	2-wire system: 12...36 V DC 3-wire system: 14...36 V DC Ex version: 14...28 V DC	
Load resistance	$R_t \leq \frac{U_s - 12 V}{0,02 A} \Omega$	2-wire system $R_t \leq \frac{U_s - 12 V}{0,02 A} \Omega$ 3-wire system: R > 10 kΩ	
Process connection	According to the order code		
Electric connection	Pg 9 DIN 43650 connector	Pg 9 DIN 43650 connector *	
Ex marking	-	ATEX II 1 G EEx ia IIC T4	
Ingress protection	IP 65	IP 65 / IP 67 *	
Electric protection	SELV Class III		
Mass	~ 0.14 kg		~ 0.5 kg

* Integral cable for special request

DIMENSIONS

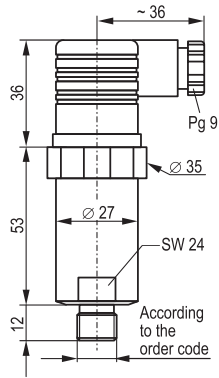

DR□ - 2□□2
Ceramic diaphragm

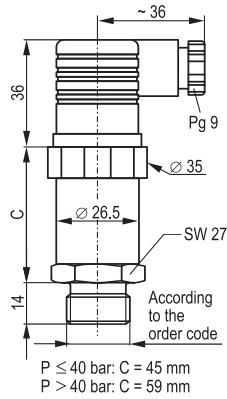

D□C - 4□□ - □
Inner st. st. diaphragm
1/2" Flush diaphragm

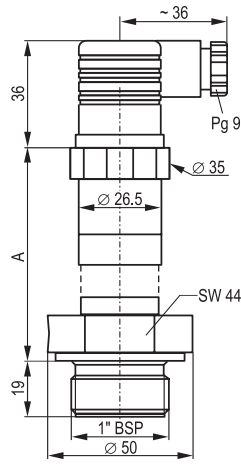

D□E - 4□□ - □
Flush diaphragm

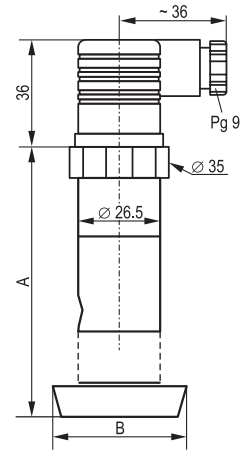

D□□ - 4□□ - □
Flush diaphragm pipe coupling

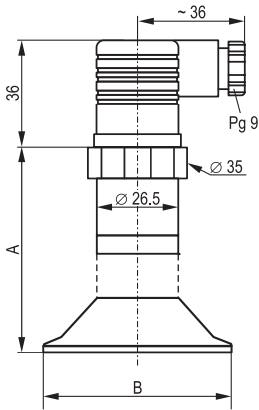

D□□ - 4□□ - □
Flush diaphragm, Tri-Clamp

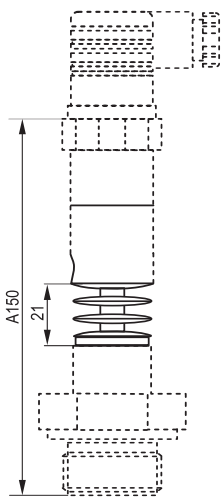

DH□ - 4□□ - □
Flush diaphragm, cooling rib
max. 150 °C

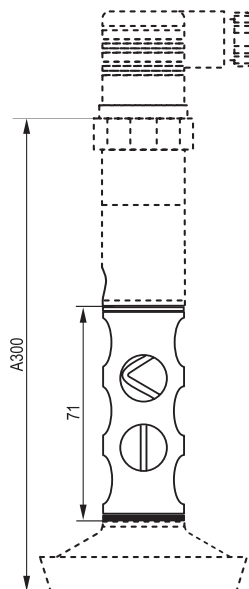

DJ□ - 4□□ - □
Flush diaphragm, tri-clamp
cooling rib max. 300 °C

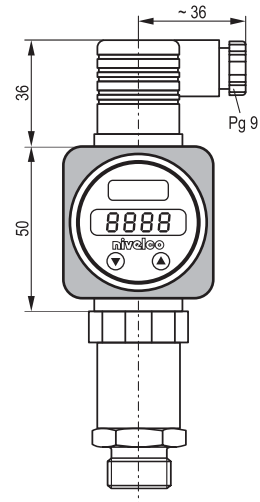

transmitter with
plug-in display
PLK-501-2

DIMENSIONS	PIPE COUPLING DIN11581			TRI-CLAMP			FLUSH DIAPHRAGM
	DN25	DN40	DN50	1"	1 1/2"	2"	1" BSP
A	71	53	53	70,5	70,5	54,5	61,5
A 150	92	74	74	91,5	91,5	75,5	82,5
A 300	142	124	124	141,5	141,5	125,5	132,5
B	44	56	68,5	50,5	50,5	64	1" BSP

Add 26.5 mm to A and C for the Ex versions

ELECTRIC CONNECTION

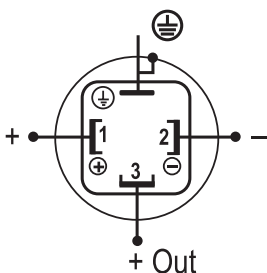

ARRANGEMENTS

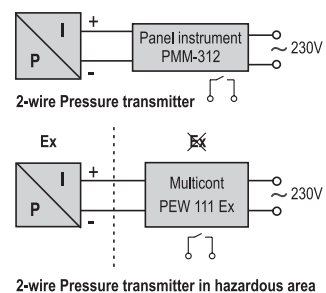
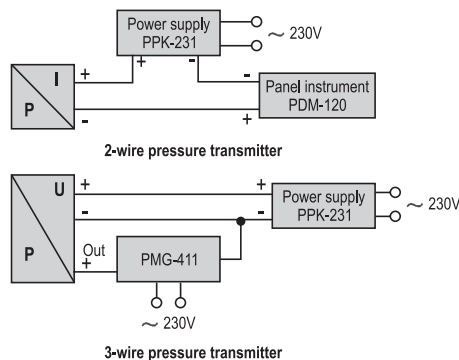

ORDER CODE

NIPRESS D R [] - 2 [] [] - 2

PROCESS CONNECTION	CODE	RANGE (OVERLOAD CAPABILITY) BAR	CODE	RANGE (OVERLOAD CAPABILITY) BAR	CODE	ACCURACY	CODE
1/4" BSP	A	0 ... 1,0 (3)	5	0 ... 25 (50)	C	0,25%	1
1/2" BSP	C	0 ... 1,6 (7)	6	0 ... 40 (120)	D	0,5%	2
		0 ... 2,5 (7)	7	0 ... 60 (120)	E		
		0 ... 4 (12)	8	0 ... 100 (250)	F		
		0 ... 6 (12)	9	0 ... 160 (400)	G		
		0 ... 10 (25)	A	0 ... 250 (400)	H		
		0 ... 16 (50)	B	0 ... 400 (600)	J		

NIPRESS D [] [] - 3 [] [] - []

PRESSURE	CODE	PROCESS CONNECTION	CODE	RANGE (2) (OVERLOAD CAPABILITY) BAR	CODE	RANGE (2) (OVERLOAD CAPABILITY) BAR	CODE	OUTPUT / Ex	CODE	ACCURACY	CODE
Relative	R	1/4" BSP	A	-1 ... 0 (3)	0	0 ... 10 (20)	A	4...20 mA	2	0,25 % (3)	1
Absolute	E (1)	1/2" BSP	C	0 ... 0,1 (0,5)	1	0 ... 16 (60)	B	0...10 V	3	0,5 %	2
		1/4" NPT	G	0 ... 0,25 (1)	2	0 ... 25 (100)	C	4...20 mA/Ex	6		
		1/2" NPT	H	0 ... 0,4 (1)	3	0 ... 40 (100)	D				
				0 ... 0,6 (3)	4	0 ... 60 (140)	E				
				0 ... 1,0 (3)	5	0 ... 100 (340)	F				
				0 ... 1,6 (6)	6	0 ... 160 (340)	G				
				0 ... 2,5 (6)	7	0 ... 250 (600)	H				
				0 ... 4,0 (20)	8	0 ... 400 (600)	J				
				0 ... 6,0 (20)	9	0 ... 600 (1000)	K				

- (1) Over 0, 1 bar
 (2) Other range for request
 (3) Over 0,4 bar

NIPRESS D [] [] - 4 [] [] - []

PRESSURE / TEMPERATURE	CODE	PROCESS CONNECTION	CODE	RANGE (4) (OVERLOAD CAPABILITY) BAR	CODE	RANGE (5) (OVERLOAD CAPABILITY) BAR	CODE	OUTPUT / Ex	CODE	ACCURACY	CODE
Relative	R	1/2" BSP (1)	C	-1 ... 0 (3)	0	0 ... 6 (20)	9	4...20 mA	2	0,25 %	1 (5)
Absolute (1)	E	1" BSP	E	0 ... 0,1 (0,5)	1	0 ... 10 (20)	A	0...10 V	3	0,5 %	2
Relative / high temp. up to 150°C	H	1" Triclamp	L (2)	0 ... 0,25 (1)	2	0 ... 16 (60)	B	4...20 mA / Ex	6		
Relative / high temp. up to 300 °C	J	1 1/2" Triclamp	M (2)	0 ... 0,4 (1)	3	0 ... 25 (60)	C				
		2" Triclamp	N (2)	0 ... 0,6 (3)	4	0 ... 40 (100)	D				
		DN25 Pipe coupl.	O (3)	0 ... 1,0 (3)	5	0 ... 60 (120)	E				
		DN40 Pipe coupl.	P (3)	0 ... 1,6 (6)	6	0 ... 100 (250)	F				
		DN50 Pipe coupl.	R (3)	0 ... 2,5 (6)	7	0 ... 160 (500)	G				
				0 ... 4,0 (20)	8	0 ... 250 (500)	H				
						0 ... 400 (600)	J				

- (1) over 0,1 bar
 (2) up to 40 bar according to ISO 2852
 (3) up to 40 bar according to DIN 11581
 (4) other range for request
 (5) over 0,4 bar

Plug-in display: **UNICONT PLK-501-2**
UNICONT PLK-501-6 Ex

Technical specification may be changed without notice