

VIPA System MICRO

SM-AIO || Manual

HB400 | SM-AIO || en | 18-06

Analog signal modules - SM M3x



VIPA GmbH
Ohmstr. 4
91074 Herzogenaurach
Telephone: 09132-744-0
Fax: 09132-744-1864
Email: info@vipa.com
Internet: www.vipa.com

Table of contents

1	General	4
	1.1 Copyright © VIPA GmbH	4
	1.2 About this manual.....	5
	1.3 Safety information.....	6
2	Basics and mounting	7
	2.1 Safety information for users.....	7
	2.2 System conception.....	8
	2.3 Dimensions.....	9
	2.4 Mounting.....	10
	2.4.1 Mounting CPU.....	10
	2.4.2 Mounting the extension module.....	13
	2.4.3 Mounting periphery module.....	14
	2.5 Wiring.....	15
	2.5.1 Wiring CPU.....	15
	2.5.2 Wiring periphery module.....	19
	2.6 Demounting.....	21
	2.6.1 Demounting CPU.....	21
	2.6.2 Demounting the extension module.....	25
	2.6.3 Demounting periphery module.....	26
	2.7 Installation guidelines.....	29
	2.8 General data.....	31
3	Analog input	33
	3.1 General.....	33
	3.2 Analog value	34
	3.3 Measuring ranges and function numbers.....	35
	3.4 M31-1CD50 - AI 4 x 16Bit U, I, RTD, TC.....	43
	3.4.1 Parameter data.....	47
	3.4.2 Diagnostics and interrupt.....	58
	3.4.3 Technical data.....	62
4	Analog output	67
	4.1 General.....	67
	4.2 Analog value.....	68
	4.3 Output ranges and function numbers.....	68
	4.4 M32-1BD40 - AO 4 x 12Bit I	71
	4.4.1 Parameter data.....	73
	4.4.2 Diagnostic data.....	75
	4.4.3 Technical data.....	78
	4.5 M32-1BD70 - AO 4 x 12Bit U	81
	4.5.1 Parameter data.....	83
	4.5.2 Diagnostic data.....	85
	4.5.3 Technical data.....	88

1 General

1.1 Copyright © VIPA GmbH

All Rights Reserved

This document contains proprietary information of VIPA and is not to be disclosed or used except in accordance with applicable agreements.

This material is protected by the copyright laws. It may not be reproduced, distributed, or altered in any fashion by any entity (either internal or external to VIPA), except in accordance with applicable agreements, contracts or licensing, without the express written consent of VIPA and the business management owner of the material.

For permission to reproduce or distribute, please contact: VIPA, Gesellschaft für Visualisierung und Prozessautomatisierung mbH Ohmstraße 4, D-91074 Herzogenaurach, Germany

Tel.: +49 9132 744 -0

Fax.: +49 9132 744-1864

E-Mail: info@vipa.de

<http://www.vipa.com>



Every effort has been made to ensure that the information contained in this document was complete and accurate at the time of publishing. Nevertheless, the authors retain the right to modify the information.

This customer document describes all the hardware units and functions known at the present time. Descriptions may be included for units which are not present at the customer site. The exact scope of delivery is described in the respective purchase contract.

CE Conformity Declaration

Hereby, VIPA GmbH declares that the products and systems are in compliance with the essential requirements and other relevant provisions. Conformity is indicated by the CE marking affixed to the product.

Conformity Information

For more information regarding CE marking and Declaration of Conformity (DoC), please contact your local VIPA customer service organization.

Trademarks

VIPA, SLIO, System 100V, System 200V, System 300V, System 300S, System 400V, System 500S and Commander Compact are registered trademarks of VIPA Gesellschaft für Visualisierung und Prozessautomatisierung mbH.

SPEED7 is a registered trademark of profichip GmbH.

SIMATIC, STEP, SINEC, TIA Portal, S7-300 and S7-400 are registered trademarks of Siemens AG.

Microsoft and Windows are registered trademarks of Microsoft Inc., USA.

Portable Document Format (PDF) and Postscript are registered trademarks of Adobe Systems, Inc.

All other trademarks, logos and service or product marks specified herein are owned by their respective companies.

Information product support

Contact your local VIPA Customer Service Organization representative if you wish to report errors or questions regarding the contents of this document. If you are unable to locate a customer service centre, contact VIPA as follows:

VIPA GmbH, Ohmstraße 4, 91074 Herzogenaurach, Germany
Telefax: +49 9132 744-1204
EMail: documentation@vipa.de

Technical support

Contact your local VIPA Customer Service Organization representative if you encounter problems with the product or have questions regarding the product. If you are unable to locate a customer service centre, contact VIPA as follows:

VIPA GmbH, Ohmstraße 4, 91074 Herzogenaurach, Germany
Tel.: +49 9132 744-1150 (Hotline)
EMail: support@vipa.de

1.2 About this manual

Target audience

The manual is targeted at users who have a background in automation technology.

Structure of the manual

The manual consists of chapters. Every chapter provides a self-contained description of a specific topic.

Guide to the document

The following guides are available in the manual:

- An overall table of contents at the beginning of the manual
- References with page numbers

Availability

The manual is available in:

- printed form, on paper
- in electronic form as PDF-file (Adobe Acrobat Reader)

Icons Headings

Important passages in the text are highlighted by following icons and headings:

**DANGER!**

Immediate or likely danger. Personal injury is possible.

**CAUTION!**

Damages to property is likely if these warnings are not heeded.



Supplementary information and useful tips.

1.3 Safety information

Applications conforming with specifications

The system is constructed and produced for:

- communication and process control
- general control and automation tasks
- industrial applications
- operation within the environmental conditions specified in the technical data
- installation into a cubicle



DANGER!

This device is not certified for applications in

- in explosive environments (EX-zone)

Documentation

The manual must be available to all personnel in the

- project design department
- installation department
- commissioning
- operation



CAUTION!

The following conditions must be met before using or commissioning the components described in this manual:

- Hardware modifications to the process control system should only be carried out when the system has been disconnected from power!
- Installation and hardware modifications only by properly trained personnel.
- The national rules and regulations of the respective country must be satisfied (installation, safety, EMC ...)

Disposal

National rules and regulations apply to the disposal of the unit!

2 Basics and mounting

2.1 Safety information for users

Handling of electrostatic sensitive modules

VIPA modules make use of highly integrated components in MOS-Technology. These components are extremely sensitive to over-voltages that can occur during electrostatic discharges. The following symbol is attached to modules that can be destroyed by electrostatic discharges.



The Symbol is located on the module, the module rack or on packing material and it indicates the presence of electrostatic sensitive equipment. It is possible that electrostatic sensitive equipment is destroyed by energies and voltages that are far less than the human threshold of perception. These voltages can occur where persons do not discharge themselves before handling electrostatic sensitive modules and they can damage components thereby, causing the module to become inoperable or unusable. Modules that have been damaged by electrostatic discharges can fail after a temperature change, mechanical shock or changes in the electrical load. Only the consequent implementation of protection devices and meticulous attention to the applicable rules and regulations for handling the respective equipment can prevent failures of electrostatic sensitive modules.

Shipping of modules

Modules must be shipped in the original packing material.

Measurements and alterations on electrostatic sensitive modules

When you are conducting measurements on electrostatic sensitive modules you should take the following precautions:

- Floating instruments must be discharged before use.
- Instruments must be grounded.

Modifying electrostatic sensitive modules you should only use soldering irons with grounded tips.



CAUTION!

Personnel and instruments should be grounded when working on electrostatic sensitive modules.

2.2 System conception

Overview

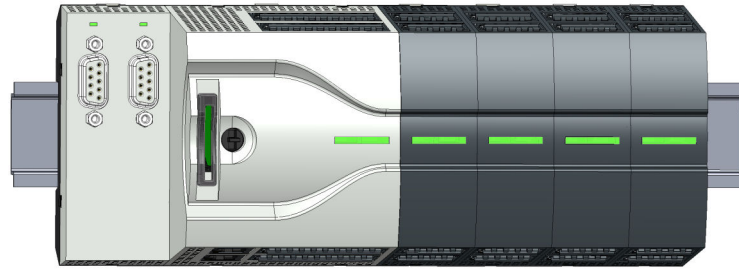

The System MICRO is a modular automation system for assembly on a 35mm mounting rail. By means of periphery modules this system may be adapted matching to your automation tasks. In addition, it is possible to expand your CPU by appropriate interfaces. The wiring complexity is low, because the DC 24V electronic section supply is integrated to the backplane bus and this allows replacement with standing wire.

Components

- CPU
- Extension module
- Periphery module

CPU

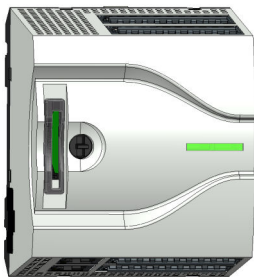

With the CPU electronic, input/output components and power supply are integrated to one casing. In addition, up to 8 periphery modules of the System MICRO can be connected to the backplane bus. As head module via the integrated power module for power supply CPU electronic and the I/O components are supplied as well as the electronic of the periphery modules, which are connected via backplane bus. To connect the power supply of the I/O components and for DC 24V electronic power supply of the periphery modules, which are connected via backplane bus, the CPU has removable connectors. By installing of up to 8 periphery modules at the backplane bus of the CPU, these are electrically connected, this means these are assigned to the backplane bus and connected to the DC 24V electronic power supply.

Extension module



By using extension modules you can extend the interfaces of the CPU. The attachment to the CPU is made by plugging on the left side of the CPU. You can only connect one extension module to the CPU at a time.

Periphery module



By means of up to 8 periphery modules, you can extend the internal I/O areas. The attachment to the CPU is made by plugging them on the right side of the CPU.

2.3 Dimensions

Dimensions CPU M13C

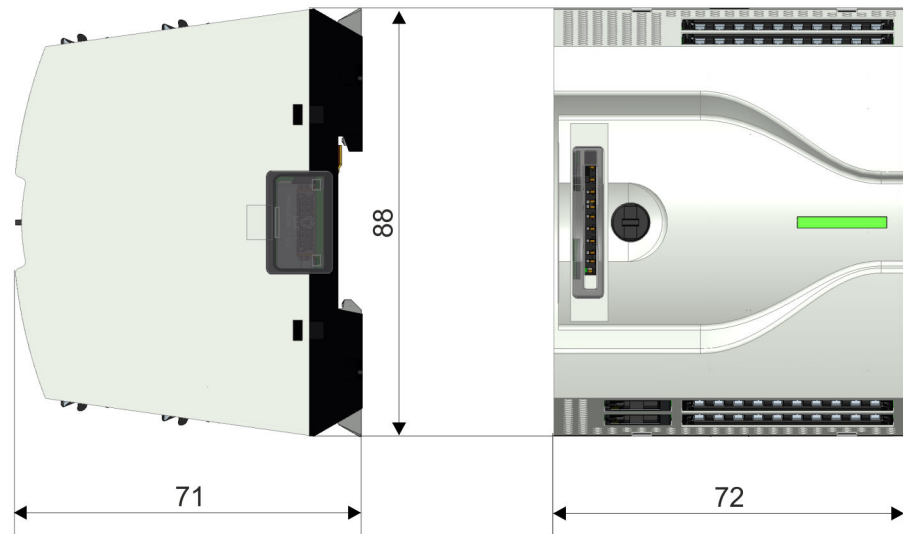

Dimensions in mm

Dimensions extension module EM M09

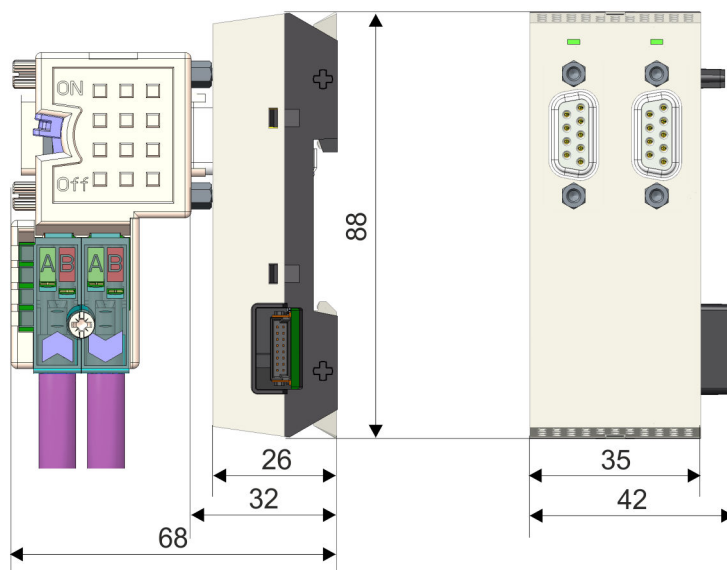

Dimensions in mm

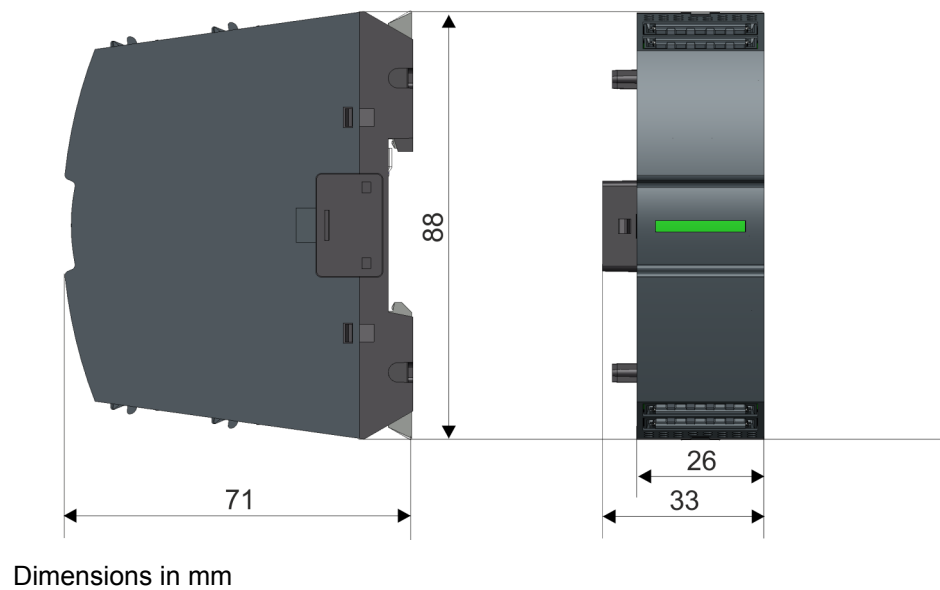
Dimensions periphery module**2.4 Mounting****2.4.1 Mounting CPU****2.4.1.1 Mounting CPU without mounting rail****CAUTION!**

Mounting without mounting rail is only permitted, if you only want to use the CPU without extension and periphery modules. Otherwise, a mounting rail must always be used for EMC technical reasons.

Proceeding

You can screw the CPU to the back wall by means of screws via the locking levers. The happens with the following proceeding:

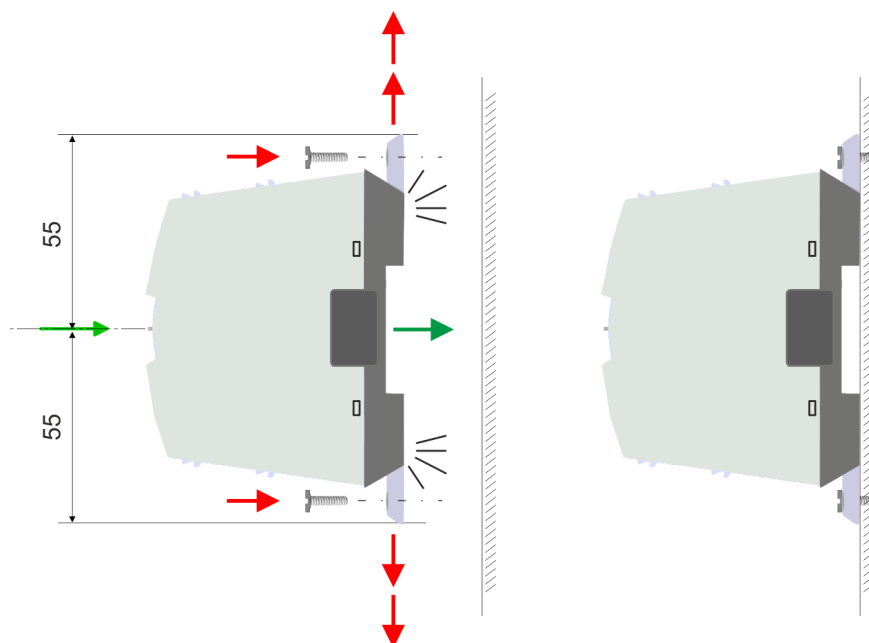

Dimensions in mm

1. ➤ The CPU has a locking lever on the upper and lower side. Pull these levers outwards as shown in the figure, until these engage 2x audible.
 - ⇨ By this openings on the locking levers get visible.
2. ➤ Use the appropriate screws to fix your CPU to your back wall. Consider the installation clearances for the CPU.
 - ⇨ The CPU is now mounted and can be wired.

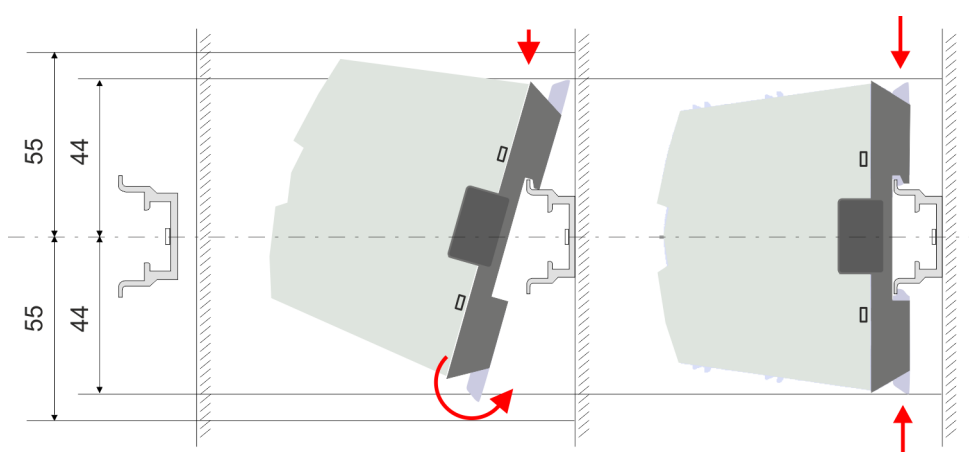
2.4.1.2 Mounting with mounting rail**Proceeding**

Dimensions in mm

1. ➤ Mount the mounting rail. Please consider that a clearance from the middle of the mounting rail of at least 44mm respectively 55mm above and below exists.

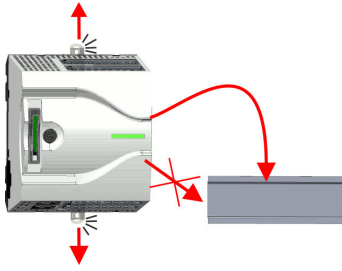

2. The CPU has a locking lever on the upper and lower side. Pull these levers outwards as shown in the figure, until these engage audible.



CAUTION!

It is not allowed to mount the module sideways on the mounting rail, as otherwise the module may be damaged.

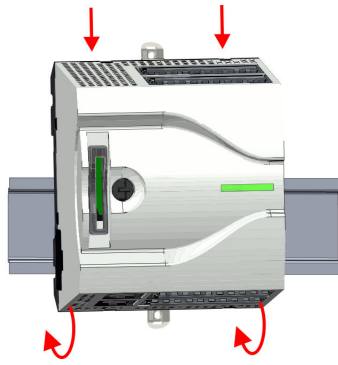

3. Plug the CPU from the top onto the mounting rail and turn the periphery module downward until it rests on the mounting rail.

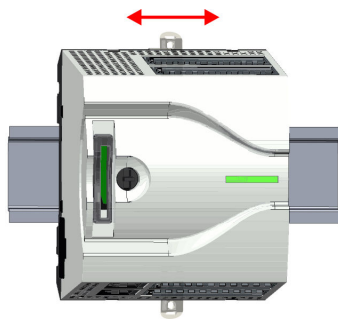

4. Move the CPU on the mounting rail at its position.

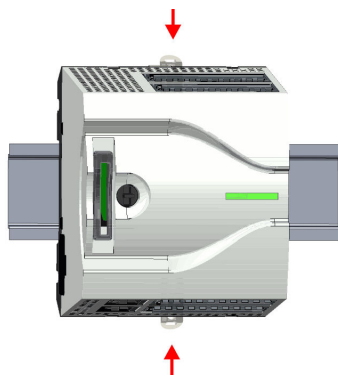

5. To fix the CPU at the mounting rail, move the locking levers back to the initial position.

⇒ The CPU is now mounted and can be wired.

2.4.2 Mounting the extension module

Proceeding

You have the possibility to extend the interfaces of the CPU by plugging an extension module. For this the extension module is plugged at the left side of the CPU. The mountings happens with the following proceeding:

1. ➤ Remove the bus cover with a screwdriver on the left side of the CPU.

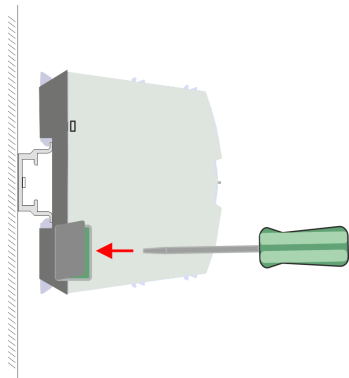

2. ➤ The extension module has a locking lever on the upper and lower side. Pull these levers outwards as shown in the figure, until these engage audible.

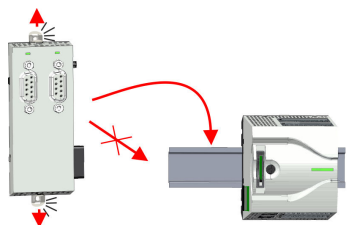

CAUTION!

It is not allowed to mount the module sideways on the mounting rail, as otherwise the module may be damaged.

3. ➤ To mount plug the extension module from the top onto the mounting rail and turn the extension module downward until it rests on the mounting rail.

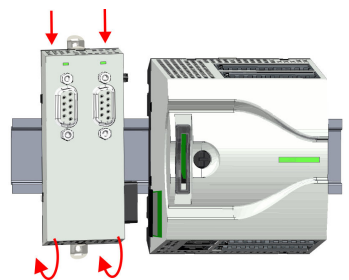

4. ➤ Attach the extension module to the CPU by sliding the extension module on the mounting rail to the right until the interface connector slightly locks into the CPU.

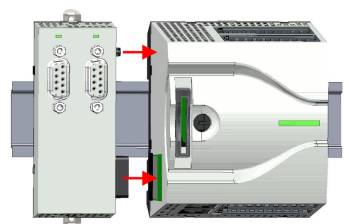

5. ➤ To fix the extension module at the mounting rail, move the locking levers back to the initial position.

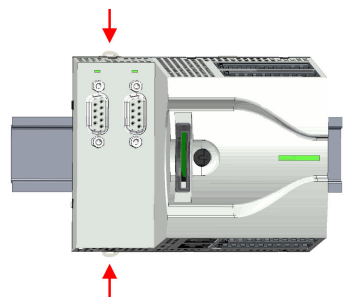

2.4.3 Mounting periphery module

Proceeding

You have the possibility to extend the periphery area of the CPU by plugging up to 8 periphery modules. For this the periphery modules are plugged at the right side of the CPU. The mountings happens with the following proceeding:

1. ➤ Remove the bus cover with a screwdriver on the right side of the CPU.

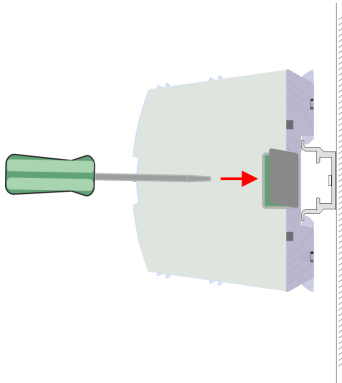

2. ➤ Each periphery module has a locking lever on its upper and lower side. Pull these levers outwards as shown in the figure, until these engage audible.

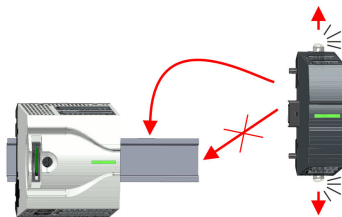

CAUTION!

It is not allowed to mount the module sideways on the mounting rail, as otherwise the module may be damaged.

3. ➤ To mount plug the periphery module from the top onto the mounting rail and turn the periphery module downward until it rests on the mounting rail.

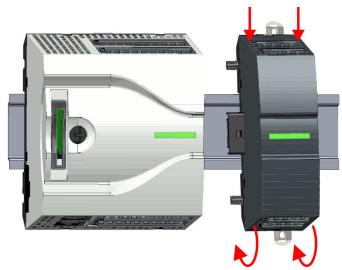

4. ➤ Attach the periphery module to the CPU by sliding the periphery module on the mounting rail to the left until the interface connector slightly locks into the CPU.

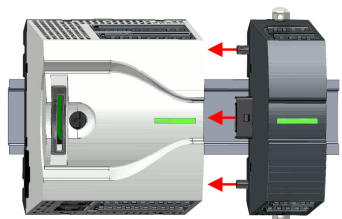

5. ➤ To fix the periphery module at the mounting rail, move the locking levers back to the initial position.

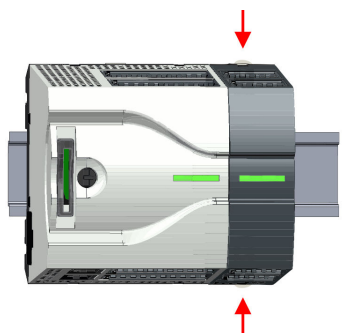

6. ➤ Proceed in this way with additional periphery modules.

2.5 Wiring



CAUTION!

Consider temperature for external cables!

Cables may experience temperature increase due to system heat dissipation. Thus the cabling specification must be chosen 5°C above ambient temperature!



CAUTION!

Separate insulation areas!

The system is specified for SELV/PELV environment. Devices, which are attached to the system must meet these specifications. Installation and cable routing other than SELV/PELV specification must be separated from the system's equipment!

2.5.1 Wiring CPU

CPU connector

For wiring the CPU has removable connectors. With the wiring of the connectors a "push-in" spring-clip technique is used. This allows a quick and easy connection of your signal and supply lines. The clamping off takes place by means of a screwdriver.

Data

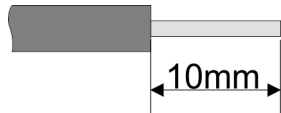

U_{max}	30V DC
I_{max}	10A
Cross section	0.2 ... 1.5mm ² (AWG 24 ... 16)
Stripping length	10mm

Use for wiring rigid wires respectively use wire sleeves. When using stranded wires you have to press the release button with a screwdriver during the wiring.

Wiring procedure

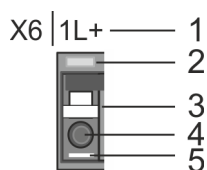

- 1 Labeling on the casing
- 2 Status LED
- 3 Release area
- 4 Connection hole for wire
- 5 Pin 1 of the connector is labelled by a white line

Insert wire

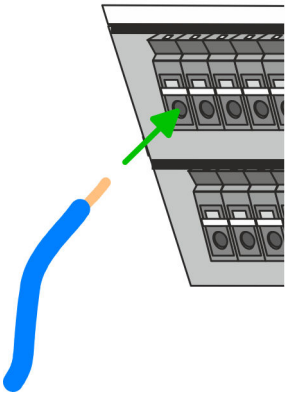

The wiring happens without a tool.

- ➔ Determine according to the casing labelling the connection position and insert through the round connection hole of the according contact your prepared wire until it stops, so that it is fixed.
- ➔ By pushing the contact spring opens, thus ensuring the necessary contact pressure.

Remove wire

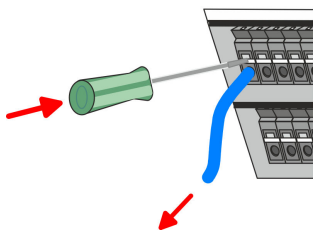

The wire is to be removed by means of a screwdriver with 2.5mm blade width.

1. ➔ Press with your screwdriver vertically at the release button.
 - ➔ The contact spring releases the wire.
2. ➔ Pull the wire from the round hole.

Standard wiring

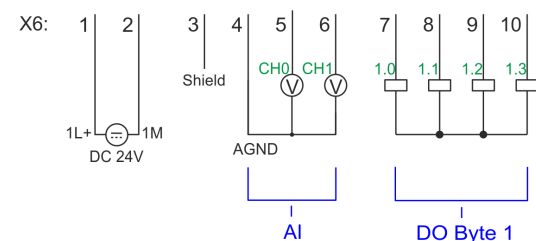
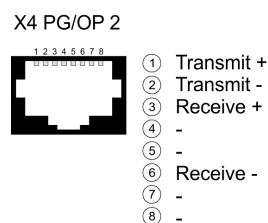
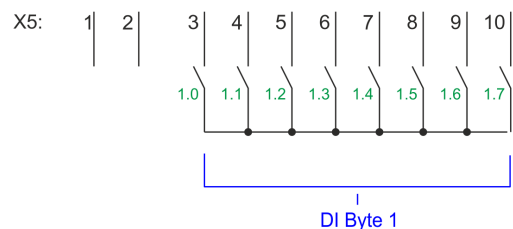
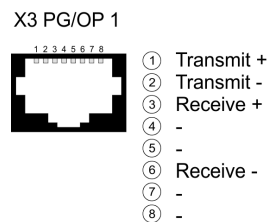
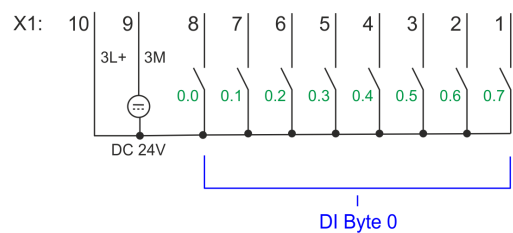
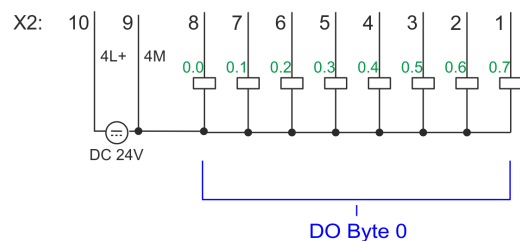
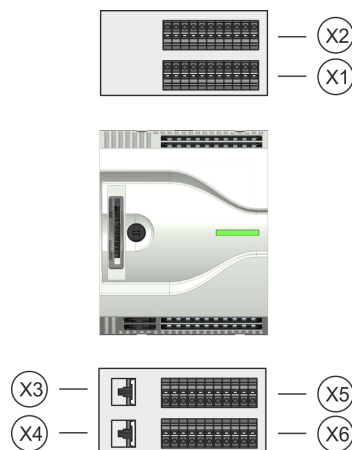

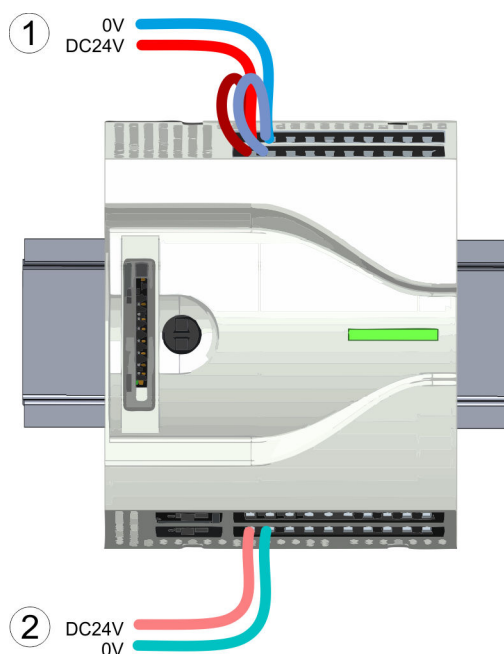

- (1) X2: 4L+: DC 24V power section supply for integrated outputs
X1: 3L+: DC 24V power section supply for integrated inputs
- (2) X6: 1L+ DC 24V for electronic power supply



The electronic power section supply is internally protected against higher voltage by fuse. The fuse is located inside the CPU and can not be changed by the user.

Fusing



CAUTION!

- The power section supply of the internal DOs is to be externally protected with a 8A fuse (fast) respectively by a line circuit breaker 8A characteristics Z.

Remove connector

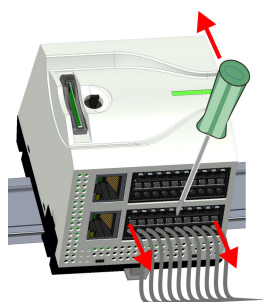

By means of a screwdriver there is the possibility to remove the connectors e.g. for module exchange with a fix wiring. For this each connector has indentations for unlocking at the top. Unlocking takes place by the following proceeding:

1. ➤ Remove connector:

Insert your screwdriver from above into one of the indentations.

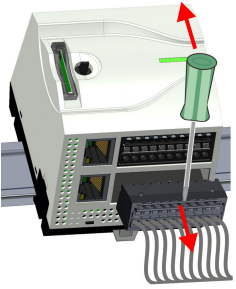

2. → Push the screwdriver backwards:
 - ⇒ The connector is unlocked and can be removed.

**CAUTION!**

Via wrong operation such as pressing, the screwdriver downward the release lever may be damaged.

3. → Plug connector:

The connector is plugged by plugging it directly into the release lever.

2.5.2 Wiring periphery module

Periphery module connector

For wiring the periphery module has removable connectors. With the wiring of the connectors a "push-in" spring-clip technique is used. This allows a quick and easy connection of your signal and supply lines. The clamping off takes place by means of a screwdriver.

Data

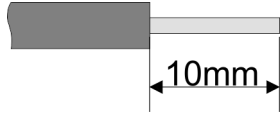

U_{max}	240V AC / 30V DC
I_{max}	10A
Cross section	0.2 ... 1.5mm ² (AWG 24 ... 16)
Stripping length	10mm

Use for wiring rigid wires respectively use wire sleeves. When using stranded wires you have to press the release button with a screwdriver during the wiring.

Wiring procedure

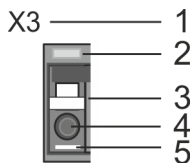

- 1 Labeling on the casing
- 2 Status LED
- 3 Release area
- 4 Connection hole for wire
- 5 Pin 1 of the connector is labelled by a white line

Insert wire

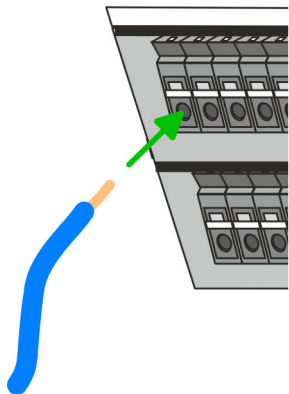

The wiring happens without a tool.

- Determine according to the casing labelling the connection position and insert through the round connection hole of the according contact your prepared wire until it stops, so that it is fixed.
 - ⇒ By pushing the contact spring opens, thus ensuring the necessary contact pressure.

Remove wire

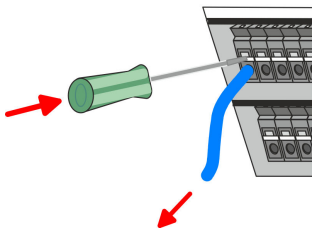

The wire is to be removed by means of a screwdriver with 2.5mm blade width.

1. → Press with your screwdriver vertically at the release button.
 - ⇒ The contact spring releases the wire.
2. → Pull the wire from the round hole.

Fusing



CAUTION!

- The power section supply of the output modules DO16 is to be externally protected with a 10A fuse (fast) respectively by a line circuit breaker 10A characteristics Z.
- The power section supply of the output part of the DIO8 is to be externally protected with a 5A fuse (fast) respectively by a line circuit breaker 5A characteristics Z.

Remove connector

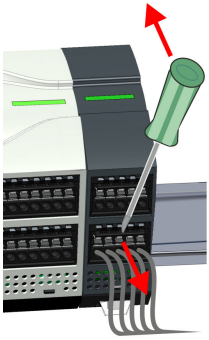

By means of a screwdriver there is the possibility to remove the connectors e.g. for module exchange with a fix wiring. For this each connector has indentations for unlocking at the top. Unlocking takes place by the following proceeding:

1. ➤ Remove connector:

Insert your screwdriver from above into one of the indentations.

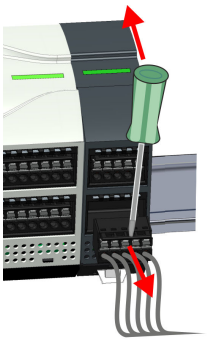

2. ➤ Push the screwdriver backwards:

⇒ The connector is unlocked and can be removed.



CAUTION!

Via wrong operation such as pressing, the screwdriver downward the release lever may be damaged.

3. ➤ Plug connector:

The connector is plugged by plugging it directly into the release lever.

2.6 Demounting

2.6.1 Demounting CPU

Remove connector

By means of a screwdriver there is the possibility to remove the connectors e.g. for module exchange with a fix wiring. For this each connector has indentations for unlocking at the top. Unlocking takes place by the following proceeding:

1. ➤ Power-off your system.

2. ➤ Remove connector:

Insert your screwdriver from above into one of the indentations.

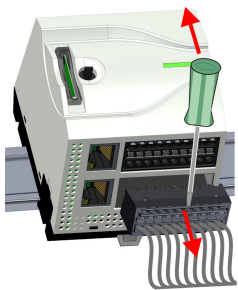
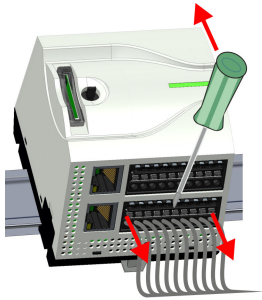

3. ➤ Push the screwdriver backwards:

⇒ The connector is unlocked and can be removed.



CAUTION!

Via wrong operation such as pressing, the screwdriver downward the connector may be damaged!

4. ➤ In this way, remove all plugged connectors on the CPU.

CPU replacement (stand-alone)

If more modules are connected to the CPU ☞ *'Option: CPU replacement in a system'* on page 23. If no other modules are connected to the CPU, the CPU is replaced according to the following proceeding:

1. ➤ Use a screwdriver to pull the locking levers of the CPU outwards until these engage audible.

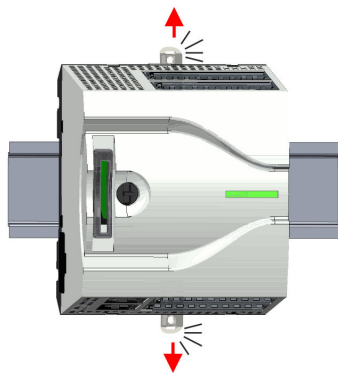

2. ➤ Remove the CPU with a rotation upwards from the mounting rail.

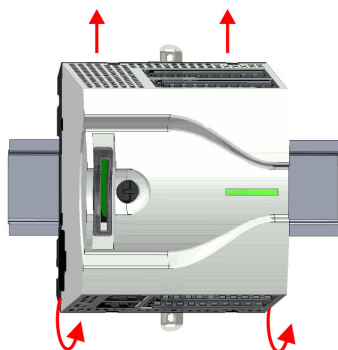

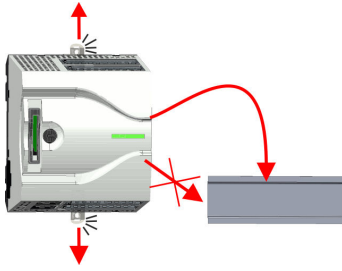

3. Pull the locking levers of the CPU outwards until these engage audible.



CAUTION!

It is not allowed to mount the module sideways on the mounting rail, as otherwise the module may be damaged!

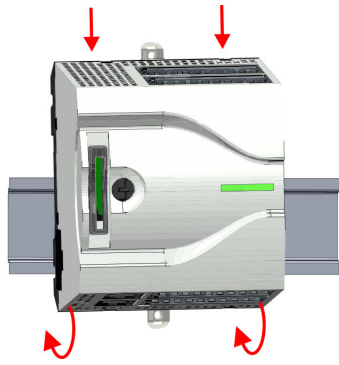

4. Plug the CPU from the top onto the mounting rail and turn the periphery module downward until it rests on the mounting rail.

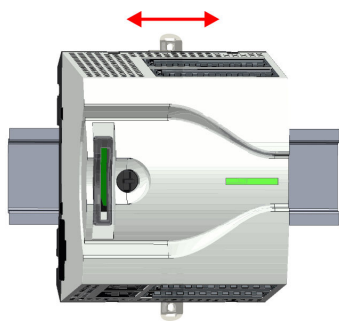

5. Move the CPU on the mounting rail at its position.

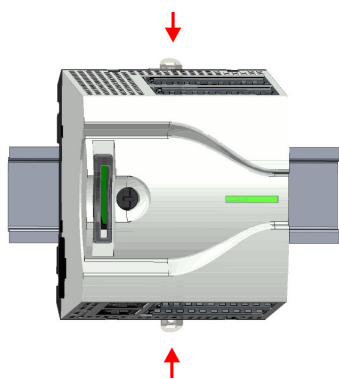

6. To fix the CPU at the mounting rail, move the locking levers back to the initial position.

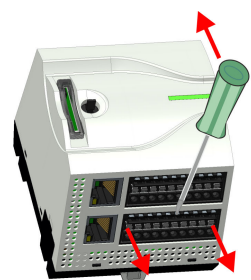

7. Remove the connectors, which are not necessary at the CPU.

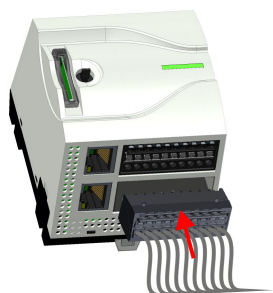

8. ➤ Plug again the wired connectors.
⇒ Now you can bring your system back into operation.

Option: CPU replacement in a system

In the following the replacement of a CPU in a system is shown:

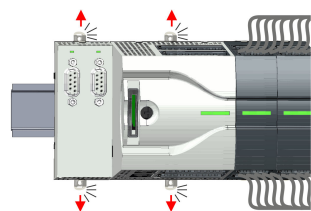

1. ➤ If there is an extension module connected to the CPU, you have to remove it from the CPU. For this use a screwdriver to pull the locking levers of the extension module and CPU outwards until these engage audible.

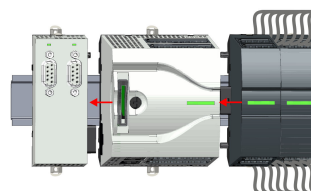

2. ➤ Disconnect all the modules, which are connected to the CPU by moving the CPU along with the extension module on the mounting rail.

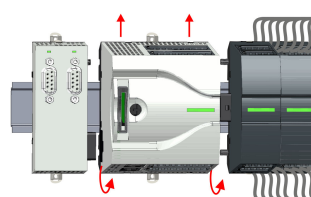

3. ➤ Remove the CPU with a rotation upwards from the mounting rail.

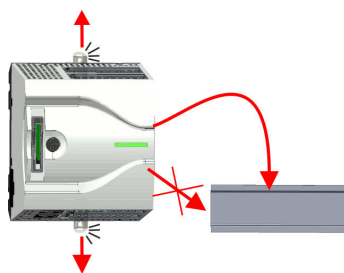

4. ➤ Pull the locking levers of the CPU outwards until these engage audible.



CAUTION!

It is not allowed to mount the module sideways on the mounting rail, as otherwise the module may be damaged!

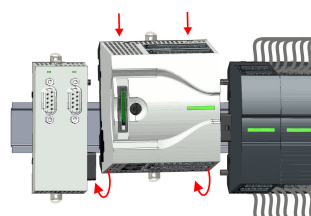

5. ➤ For mounting pull the locking levers of the CPU outwards until these engage audible. Plug the CPU from the top onto the mounting rail and turn the periphery module downward until it rests on the mounting rail.

Demounting > Demounting CPU

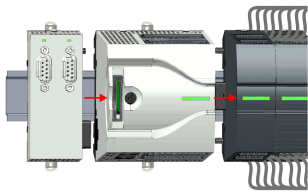

6. ➤ Rebind your modules by moving the CPU along with the extension module on the mounting rail.

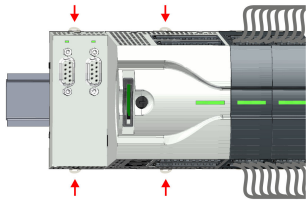

7. ➤ To fix the CPU at the mounting rail, move the locking levers back to the initial position.

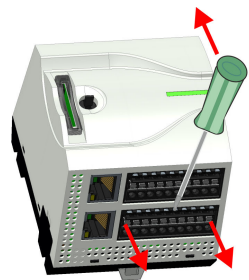

8. ➤ Remove the connectors, which are not necessary at the CPU.



9. ➤ Plug again the wired connectors.
 ⇒ Now you can bring your system back into operation.

2.6.2 Demounting the extension module

Proceeding

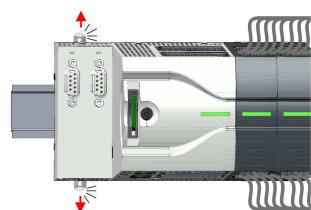

1. ➤ Power-off your system.
2. ➤ Remove the corresponding bus connectors.
3. ➤ Use a screwdriver to pull the locking levers of the extension module outwards until these engage audible.

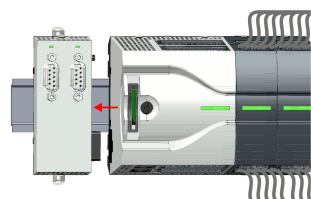

4. ➤ Remove the extension module from the CPU by sliding it on the mounting rail.

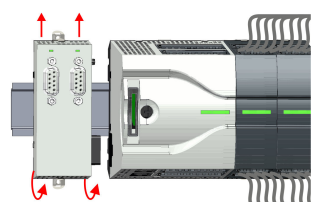

5. ➤ Remove the extension module with a rotation upwards from the mounting rail.

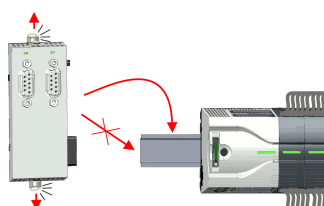

6. ➤ Pull the locking levers of the extension module outwards until these engage audible.



CAUTION!

It is not allowed to mount the module sideways on the mounting rail, as otherwise the module may be damaged!

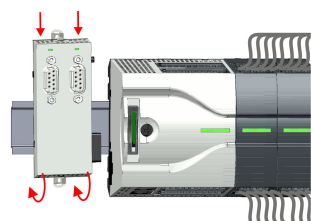

7. ➤ Plug the extension module from the top onto the mounting rail and turn the extension module downward until it rests on the mounting rail.

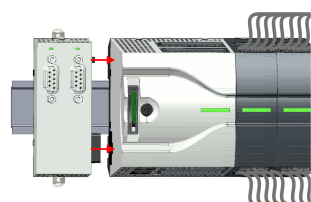

8. ➤ Reattach the extension module to the CPU by sliding the extension module on the mounting rail to the right until the interface connector slightly locks into the CPU.

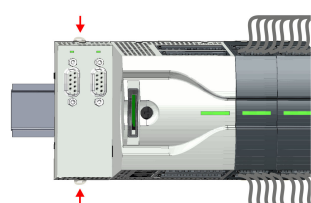

9. ➤ Move the locking levers back to the initial position.
10. ➤ Plug the corresponding bus connectors.
 - ⇒ Now you can bring your system back into operation.

2.6.3 Demounting periphery module

Remove connector

By means of a screwdriver there is the possibility to remove the connectors e.g. for module exchange with a fix wiring. For this each connector has indentations for unlocking at the top. Unlocking takes place by the following proceeding:

1. ➤ Power-off your system.



CAUTION!

Make sure that the working contacts from the relay module are disconnected from the power supply!

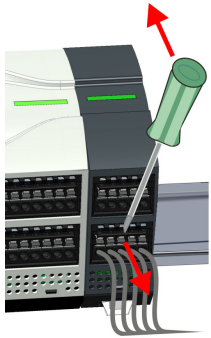

2. ➤ Remove connector:

Insert your screwdriver from above into one of the indentations.

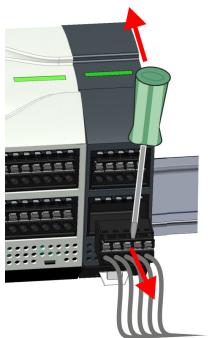

3. ➤ Push the screwdriver backwards:

⇒ The connector is unlocked and can be removed.



CAUTION!

Via wrong operation such as pressing, the screwdriver downward the connector may be damaged!

4. ➤ In this way, remove all plugged connectors on the periphery module.

Replace the periphery module

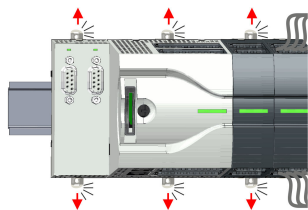

1. ➤ Remove the modules that are connected to the module to be replaced by pulling their release levers outwards until these engage audible ...

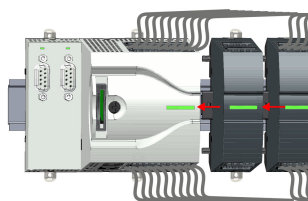

2. ➤ ... and move the modules accordingly.

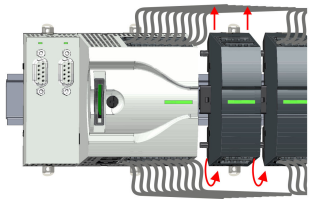

3. ➔ Remove the periphery module with a rotation upwards from the mounting rail.

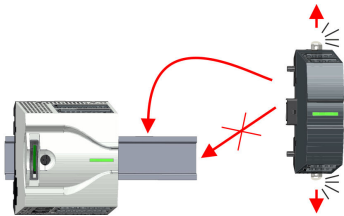

4. ➔ Pull the locking levers outwards until these engage audible.



CAUTION!

It is not allowed to mount the module sideways on the mounting rail, as otherwise the module may be damaged!

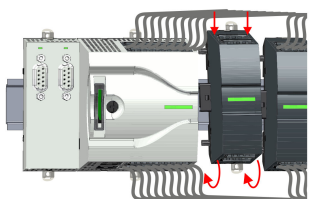

5. ➔ Plug the periphery module from the top onto the mounting rail and turn the periphery module downward until it rests on the mounting rail.

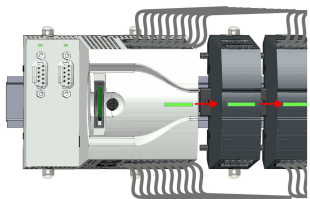

6. ➔ Reconnect all modules by pushing them together again on the mounting rail.

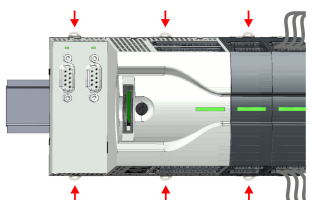

7. ➔ Move the locking levers back to the initial position.



8. ➔ Remove the connectors, which are not necessary.

Demounting > Demounting periphery module



- 9.** → Plug again the wired connectors.
⇒ Now you can bring your system back into operation.

2.7 Installation guidelines

General	<p>The installation guidelines contain information about the interference free deployment of a PLC system. There is the description of the ways, interference may occur in your PLC, how you can make sure the electromagnetic compatibility (EMC), and how you manage the isolation.</p>
What does EMC mean?	<p>Electromagnetic compatibility (EMC) means the ability of an electrical device, to function error free in an electromagnetic environment without being interfered respectively without interfering the environment.</p> <p>The components of VIPA are developed for the deployment in industrial environments and meets high demands on the EMC. Nevertheless you should project an EMC planning before installing the components and take conceivable interference causes into account.</p>
Possible interference causes	<p>Electromagnetic interferences may interfere your control via different ways:</p> <ul style="list-style-type: none">■ Electromagnetic fields (RF coupling)■ Magnetic fields with power frequency■ Bus system■ Power supply■ Protected earth conductor <p>Depending on the spreading medium (lead bound or lead free) and the distance to the interference cause, interferences to your control occur by means of different coupling mechanisms.</p> <p>There are:</p> <ul style="list-style-type: none">■ galvanic coupling■ capacitive coupling■ inductive coupling■ radiant coupling
Basic rules for EMC	<p>In the most times it is enough to take care of some elementary rules to guarantee the EMC. Please regard the following basic rules when installing your PLC.</p> <ul style="list-style-type: none">■ Take care of a correct area-wide grounding of the inactive metal parts when installing your components.<ul style="list-style-type: none">– Install a central connection between the ground and the protected earth conductor system.– Connect all inactive metal extensive and impedance-low.– Please try not to use aluminium parts. Aluminium is easily oxidizing and is therefore less suitable for grounding.■ When cabling, take care of the correct line routing.<ul style="list-style-type: none">– Organize your cabling in line groups (high voltage, current supply, signal and data lines).– Always lay your high voltage lines and signal respectively data lines in separate channels or bundles.– Route the signal and data lines as near as possible beside ground areas (e.g. suspension bars, metal rails, tin cabinet).

- Proof the correct fixing of the lead isolation.
 - Data lines must be laid isolated.
 - Analog lines must be laid isolated. When transmitting signals with small amplitudes the one sided laying of the isolation may be favourable.
 - Lay the line isolation extensively on an isolation/protected earth conductor rail directly after the cabinet entry and fix the isolation with cable clamps.
 - Make sure that the isolation/protected earth conductor rail is connected impedance-low with the cabinet.
 - Use metallic or metallised plug cases for isolated data lines.
- In special use cases you should appoint special EMC actions.
 - Consider to wire all inductivities with erase links.
 - Please consider luminescent lamps can influence signal lines.
- Create a homogeneous reference potential and ground all electrical operating supplies when possible.
 - Please take care for the targeted employment of the grounding actions. The grounding of the PLC serves for protection and functionality activity.
 - Connect installation parts and cabinets with your PLC in star topology with the isolation/protected earth conductor system. So you avoid ground loops.
 - If there are potential differences between installation parts and cabinets, lay sufficiently dimensioned potential compensation lines.

Isolation of conductors

Electrical, magnetically and electromagnetic interference fields are weakened by means of an isolation, one talks of absorption. Via the isolation rail, that is connected conductive with the rack, interference currents are shunt via cable isolation to the ground. Here you have to make sure, that the connection to the protected earth conductor is impedance-low, because otherwise the interference currents may appear as interference cause.

When isolating cables you have to regard the following:

- If possible, use only cables with isolation tangle.
- The hiding power of the isolation should be higher than 80%.
- Normally you should always lay the isolation of cables on both sides. Only by means of the both-sided connection of the isolation you achieve high quality interference suppression in the higher frequency area. Only as exception you may also lay the isolation one-sided. Then you only achieve the absorption of the lower frequencies. A one-sided isolation connection may be convenient, if:
 - the conduction of a potential compensating line is not possible.
 - analog signals (some mV respectively μA) are transferred.
 - foil isolations (static isolations) are used.
- With data lines always use metallic or metallised plugs for serial couplings. Fix the isolation of the data line at the plug rack. Do not lay the isolation on the PIN 1 of the plug bar!
- At stationary operation it is convenient to strip the insulated cable interruption free and lay it on the isolation/protected earth conductor line.
- To fix the isolation tangles use cable clamps out of metal. The clamps must clasp the isolation extensively and have well contact.
- Lay the isolation on an isolation rail directly after the entry of the cable in the cabinet. Lead the isolation further on to your PLC and don't lay it on there again!



CAUTION!

Please regard at installation!

At potential differences between the grounding points, there may be a compensation current via the isolation connected at both sides.

Remedy: Potential compensation line

2.8 General data

Conformity and approval

Conformity		
CE	2014/35/EU	Low-voltage directive
	2014/30/EU	EMC directive
Approval		
UL	-	Refer to Technical data
others		
RoHS	2011/65/EU	Restriction of the use of certain hazardous substances in electrical and electronic equipment

Protection of persons and device protection

Type of protection	-	IP20
Electrical isolation		
to the field bus	-	electrically isolated
to the process level	-	electrically isolated
Insulation resistance	-	-
Insulation voltage to reference earth		
Inputs / outputs	-	AC / DC 50V, test voltage AC 500V
Protective measures	-	against short circuit

Environmental conditions to EN 61131-2

Climatic		
Storage / transport	EN 60068-2-14	-25...+70°C
Operation		
Horizontal installation hanging	EN 61131-2	0...+60°C
Horizontal installation lying	EN 61131-2	0...+60°C
Vertical installation	EN 61131-2	0...+60°C
Air humidity	EN 60068-2-30	RH1 (without condensation, rel. humidity 10...95%)
Pollution	EN 61131-2	Degree of pollution 2
Installation altitude max.	-	2000m
Mechanical		
Oscillation	EN 60068-2-6	1g, 9Hz ... 150Hz
Shock	EN 60068-2-27	15g, 11ms

General data

Mounting conditions

Mounting place	-	In the control cabinet
Mounting position	-	Horizontal and vertical

EMC	Standard	Comment	
Emitted interference	EN 61000-6-4	Class A (Industrial area)	
Noise immunity zone B	EN 61000-6-2	Industrial area	
		EN 61000-4-2	ESD 8kV at air discharge (degree of severity 3), 4kV at contact discharge (degree of severity 2)
		EN 61000-4-3	HF field immunity (casing) 80MHz ... 1000MHz, 10V/m, 80% AM (1kHz) 1.4GHz ... 2.0GHz, 3V/m, 80% AM (1kHz) 2GHz ... 2.7GHz, 1V/m, 80% AM (1kHz)
		EN 61000-4-6	HF conducted 150kHz ... 80MHz, 10V, 80% AM (1kHz)
		EN 61000-4-4	Burst, degree of severity 3
	EN 61000-4-5	Surge, degree of severity 3 *	

*) Due to the high-energetic single pulses with Surge an appropriate external protective circuit with lightning protection elements like conductors for lightning and overvoltage is necessary.

3 Analog input

3.1 General

Cables for analog signals

For analog signals you should use screened cables to reduce interference. The cable screening should be grounded at both ends. If there are differences in the potential between the cable ends, there may occur a potential compensating current that could disturb the analog signals. In this case you should ground the cable screening only at one end.

Connecting sensors

Depending on the module the following sensors may be connected to the analog input modules:

- Current sensor
- Voltage sensor
- Resistance-type sensors
- Temperature sensors



*Please take care of the correct polarity when installing the sensors!
Please install short circuits at non-used inputs by connecting the positive contact with the channel ground of the according channel.*

Parameterization

The parameterization via CPU, PROFIBUS and PROFINET happens by means of record sets (DS). The corresponding record set number may be found at the respective module description.

Diagnostic functions

The modules have diagnostics capability. The following errors can release a diagnostic:

- Error in parameterization
- Measuring range over-/underflow
- Wire break



Alternated blinking of the channel error LEDs

The alternate blinking of the channel error LEDs of channel 0 and 1 indicates a watchdog error due to a system overload. Restart with a power cycle your system. If the error occurred again, check configuration and circuit and adjust them if necessary. If the error persists, please contact our support.

3.2 Analog value

Representation of analog values

Analog values are exclusively processed in a binary format. For this the analog module transforms every process signal into a digital value and transfers this as word. The analog values are displayed as a fixed-point number in the two's complement.

Resolution	Analog value															
	High byte (byte 0)								Low byte (byte 1)							
Bit number	15	14	13	12	11	10	9	8	7	6	5	4	3	2	1	0
Value	SG	2^{14}	2^{13}	2^{12}	2^{11}	2^{10}	2^9	2^8	2^7	2^6	2^5	2^4	2^3	2^2	2^1	2^0
16bit	SG	Measuring value														

Sign bit (SG)

Here it is essential:

- Bit 15 = "0": → positive value
- Bit 15 = "1": → negative value

Behavior at error

As soon as a measured value exceeds the overdrive region respectively falls below the underdrive region, the following value is issued:

- Measuring value > end of overdrive region:
32767 (7FFFh)
- Measuring value < end of underdrive region:
-32768 (8000h)

At a parameterization error the value 32767 (7FFFh) is issued.

3.3 Measuring ranges and function numbers

General

In the following there are the measuring ranges with function number listed, which were supported by the corresponding analog module. The here listed formulas allow you to transform an evaluated measuring value (analog value) to a value assigned to the measuring range (digital value) and vice versa.

Voltage

0 ... 10V

Meas. range (funct. no.)	Voltage (U)	Decimal (D)	Hex	Range	Formulas
0 ... 10V Siemens S7 format (10h)	11.76V	32511	7EFFh	overrange	$D = 27648 \cdot \frac{U}{10}$ $U = D \cdot \frac{10}{27648}$
	10V	27648	6C00h	nominal range	
	5V	13824	3600h		
	0V	0	0000h		
	-1.76V	-4864	ED00h	underrange	
0 ... 10V Siemens S5 format (20h)	12.5V	20480	5000h	overrange	$D = 16384 \cdot \frac{U}{10}$ $U = D \cdot \frac{10}{16384}$
	10V	16384	4000h	nominal range	
	5V	8192	2000h		
	0V	0	0000h		
	-2V	-3277	F333h	underrange	

Voltage

±10V

Meas. range (funct. no.)	Voltage (U)	Decimal (D)	Hex	Range	Formulas
±10V Siemens S7 format (12h)	11.76V	32511	7EFFh	overrange	$D = 27648 \cdot \frac{U}{10}$ $U = D \cdot \frac{10}{27648}$
	10V	27648	6C00h	nominal range	
	5V	13824	3600h		
	0V	0	0000h		
	-5V	-13824	CA00h		
	-10V	-27648	9400h		
	-11.76V	-32512	8100h	underrange	
±10V Siemens S5 format (22h)	12.5V	20480	5000h	overrange	$D = 16384 \cdot \frac{U}{10}$ $U = D \cdot \frac{10}{16384}$
	10V	16384	4000h	nominal range	
	5V	8192	2000h		
	0V	0	0000h		
	-5V	-8192	E000h		
	-10V	-16384	C000h		
	-12.5V	-20480	B000h	underrange	

Measuring ranges and function numbers

Current

0(4) ... 20mA

Meas. range (funct. no.)	Current (I)	Decimal (D)	Hex	Range	Formulas
0 ... 20mA Siemens S7 format (31h)	23.52mA	32511	7EFFh	overrange	$D = 27648 \cdot \frac{I}{20}$ $I = D \cdot \frac{20}{27648}$
	20mA	27648	6C00h	nominal range	
	10mA	13824	3600h		
	0mA	0	0000h		
	-3.52mA	-4864	ED00h	underrange	
0 ... 20mA Siemens S5 format (41h)	25.00mA	20480	5000h	overrange	$D = 16384 \cdot \frac{I}{20}$ $I = D \cdot \frac{20}{16384}$
	20mA	16384	4000h	nominal range	
	10mA	8192	2000h		
	0mA	0	0000h		
	-4,00mA	-3277	F333h	underrange	
4 ... 20mA Siemens S7 format (30h)	22.81mA	32511	7EFFh	overrange	$D = 27648 \cdot \frac{I-4}{16}$ $I = D \cdot \frac{16}{27648} + 4$
	20mA	27648	6C00h	nominal range	
	12mA	13824	3600h		
	4mA	0	0000h		
	1.19mA	-4864	ED00h	underrange	
4 ... 20mA Siemens S5 format (40h)	24.00mA	20480	5000h	overrange	$D = 16384 \cdot \frac{I-4}{16}$ $I = D \cdot \frac{16}{16384} + 4$
	20mA	16384	4000h	nominal range	
	12mA	8192	2000h		
	4mA	0	0000h		
	0.8mA	-3277	F333h	underrange	

RTD

Measuring range (funct. no.)	Measuring value	Signal range	Range
2 wire: PT100 (50h)	+1000°C	+10000	overrange
	-200 ... +850°C	-2000 ... +8500	nominal range
	-243°C	-2430	underrange
2 wire: PT1000 (51h)	+1000°C	+10000	overrange
	-200 ... +850°C	-2000 ... +8500	nominal range
	-243°C	-2430	underrange
2 wire: NI100 (52h)	+295°C	+2950	overrange
	-60 ... +250°C	-600 ... +2500	nominal range
	-105°C	-1050	underrange

Measuring range (funct. no.)	Measuring value	Signal range	Range
2 wire: NI1000 (53h)	+295°C	+2950	overrange
	-60 ... +250°C	-600 ... +2500	nominal range
	-105°C	-1050	underrange
3 wire: PT100 (58h)	+1000°C	+10000	overrange
	-200 ... +850°C	-2000 ... +8500	nominal range
	-243°C	-2430	underrange
3 wire: PT1000 (59h)	+1000°C	+10000	overrange
	-200 ... +850°C	-2000 ... +8500	nominal range
	-243°C	-2430	underrange
3 wire: NI100 (5Ah)	+295°C	+2950	overrange
	-60 ... +250°C	-600 ... +2500	nominal range
	-105°C	-1050	underrange
3 wire: NI1000 (5Bh)	+295°C	+2950	overrange
	-60 ... +250°C	-600 ... +2500	nominal range
	-105°C	-1050	underrange
4 wire: PT100 (60h)	+1000°C	+10000	overrange
	-200 ... +850°C	-2000 ... +8500	nominal range
	-243°C	-2430	underrange
4 wire: PT1000 (61h)	+1000°C	+10000	overrange
	-200 ... +850°C	-2000 ... +8500	nominal range
	-243°C	-2430	underrange
4 wire: NI100 (62h)	+295°C	+2950	overrange
	-60 ... +250°C	-600 ... +2500	nominal range
	-105°C	-1050	underrange
4 wire: NI1000 (63h)	+295°C	+2950	overrange
	-60 ... +250°C	-600 ... +2500	nominal range
	-105°C	-1050	underrange
2 wire: 0 ... 60Ω (70h)	---	---	overrange
	0 ... 60Ω	0 ... 32767	nominal range
	---	---	underrange
2 wire: 0 ... 600Ω (71h)	---	---	overrange
	0 ... 600Ω	0 ... 32767	nominal range
	---	---	underrange
2 wire: 0 ... 3000Ω (72h)	---	---	overrange
	0 ... 3000Ω	0 ... 32767	nominal range

Measuring ranges and function numbers

Measuring range (funct. no.)	Measuring value	Signal range	Range
	---	---	underrange
3 wire: 0 ... 60Ω (78h)	---	---	overrange
	0 ... 60Ω	0 ... 32767	nominal range
	---	---	underrange
3 wire: 0 ... 600Ω (79h)	---	---	overrange
	0 ... 600Ω	0 ... 32767	nominal range
	---	---	underrange
3 wire: 0 ... 3000Ω (7Ah)	---	---	overrange
	0 ... 3000Ω	0 ... 32767	nominal range
	---	---	underrange
4 wire: 0 ... 60Ω (80h)	---	---	overrange
	0 ... 60Ω	0 ... 32767	nominal range
	---	---	underrange
4 wire: 0 ... 600Ω (81h)	---	---	overrange
	0 ... 600Ω	0 ... 32767	nominal range
	---	---	underrange
4 wire: 0 ... 3000Ω (82h)	---	---	overrange
	0 ... 3000Ω	0 ... 32767	nominal range
	---	---	underrange
2 wire: 0 ... 60Ω (90h)	---	---	overrange
	0 ... 60Ω	0 ... 6000	nominal range
	---	---	underrange
2 wire: 0 ... 600Ω (91h)	---	---	overrange
	0 ... 600Ω	0 ... 6000	nominal range
	---	---	underrange
2 wire: 0 ... 3000Ω (92h)	---	---	overrange
	0 ... 3000Ω	0 ... 30000	nominal range
	---	---	underrange
3 wire: 0 ... 60Ω (98h)	---	---	overrange
	0 ... 60Ω	0 ... 6000	nominal range
	---	---	underrange
3 wire: 0 ... 600Ω (99h)	---	---	overrange
	0 ... 600Ω	0 ... 6000	nominal range
	---	---	underrange
3 wire: 0 ... 3000Ω	---	---	overrange

Measuring range (funct. no.)	Measuring value	Signal range	Range
(9Ah)	0 ... 3000Ω	0 ... 30000	nominal range
	---	---	underrange
4 wire: 0 ... 60Ω (A0h)	---	---	overrange
	0 ... 60Ω	0 ... 6000	nominal range
4 wire: 0 ... 600Ω (A1h)	---	---	overrange
	0 ... 600Ω	0 ... 6000	nominal range
4 wire: 0 ... 3000Ω (A2h)	---	---	overrange
	0 ... 3000Ω	0 ... 30000	nominal range
2 wire: 0 ... 60Ω (D0h)	70.55Ω	32511	overrange
	0 ... 60Ω	0 ... 27648	nominal range
2 wire: 0 ... 600Ω (D1h)	705.5Ω	32511	overrange
	0 ... 600Ω	0 ... 27648	nominal range
2 wire: 0 ... 3000Ω (D2h)	3528Ω	32511	overrange
	0 ... 3000Ω	0 ... 27648	nominal range
3 wire: 0 ... 60Ω (D8h)	70.55Ω	32511	overrange
	0 ... 60Ω	0 ... 27648	nominal range
3 wire: 0 ... 600Ω (D9h)	705.5Ω	32511	overrange
	0 ... 600Ω	0 ... 27648	nominal range
3 wire: 0 ... 3000Ω (DAh)	3528Ω	32511	overrange
	0 ... 3000Ω	0 ... 27648	nominal range
4 wire: 0 ... 60Ω (E0h)	70.55Ω	32511	overrange
	0 ... 60Ω	0 ... 27648	nominal range
4 wire: 0 ... 600Ω (E1h)	705.5Ω	32511	overrange
	0 ... 600Ω	0 ... 27648	nominal range
	---	---	underrange

Measuring ranges and function numbers

Measuring range (funct. no.)	Measuring value	Signal range	Range
4 wire: 0 ... 3000Ω (E2h)	3528Ω	32511	overrange
	0 ... 3000Ω	0 ... 27648	nominal range
	---	---	underrange

TC

-80 ... 80mV

Meas. range (funct. no.)	Voltage (U)	Decimal (D)	Hex	Range	Formulas
-80 ... 80mV Siemens S7 format (11h)	94.07mV	32511	7EFFh	overrange	$D = 27648 \cdot \frac{U}{80}$ $U = D \cdot \frac{80}{27648}$
	80mV	27648	6C00h	nominal range	
	0V	0	0000h		
	-80mV	-27648	9400h		
	-94.07mV	-32512	8100h	underrange	
-80 ... 80mV Siemens S5 format (21h)	100mV	20480	5000h	overrange	$D = 16384 \cdot \frac{U}{80}$ $U = D \cdot \frac{80}{16384}$
	80mV	16384	4000h	nominal range	
	0V	0	0000h		
	-80mV	-16384	C000h		
	-100mV	-20480	B000h	underrange	

TC

Temperature

Measuring range (funct. no.)	Measuring value in °C (0.1°C/digit)	Measuring value in °F (0.1°F/digit)	Measuring value in K (0.1K/digit)	Range
Type J: [Fe-Cu-Ni IEC] -210 ... +1200°C -346 ... 2192°F 63.2 ... 1473.2K (B0h: ext. comp. 0°C) (C0h: int. comp. 0°C)	+14500	26420	17232	overrange
	-2100 ... +12000	-3460 ... 21920	632 ... 14732	nominal range
	---	---	---	underrange
Type K: [Ni-Cr-Ni] -270 ... +1372°C -454 ... 2501.6°F 0 ... 1645.2K (B1h: ext. comp. 0°C)	+16220	29516	18952	overrange
	-2700 ... +13720	-4540 ... 25016	0 ... 16452	nominal range

Measuring range (funct. no.)	Measuring value in °C (0.1°C/digit)	Measuring value in °F (0.1°F/digit)	Measuring value in K (0.1K/digit)	Range
(C1h: int. comp. 0°C)	---	---	---	underrange
Type N: [Ni-Cr-Si] -270 ... +1300°C -454 ... 2372°F 0 ... 1573.2K (B2h: ext. comp. 0°C) (C2h: int. comp. 0°C)	+15500 -2700 ... +13000 ---	28220 -4540 ... 23720 ---	18232 0 ... 15732 ---	overrange nominal range underrange
Type R: [PtRh-Pt] -50 ... +1769°C -58 ... 3216.2°F 223.2 ... 2042.2K (B3h: ext. comp. 0°C) (C3h: int. comp. 0°C)	+20190 -500 ... +17690 -1700	32766 -580 ... 32162 -2740	22922 2232 ... 20422 1032	overrange nominal range underrange
Type S: [PtRh-Pt] -50 ... +1769°C -58 ... 3216.2°F 223.2 ... 2042.2K (B4h: ext. comp. 0°C) (C4h: int. comp. 0°C)	+20190 -500 ... +17690 -1700	32766 -580 ... 32162 -2740	22922 2232 ... 20422 1032	overrange nominal range underrange
Type T: [Cu-Cu-Ni] -270 ... +400°C -454 ... 752°F 3.2 ... 673.2K (B5h: ext. comp. 0°C) (C5h: int. comp. 0°C)	+5400 -2700 ... +4000 ---	10040 -4540 ... 7520 ---	8132 32 ... 6732 ---	overrange nominal range underrange
Type B: [PtRh-PtRh] 0 ... +1820°C 32 ... 2786.5°F 273.2 ... 2093.2K (B6h: ext. comp. 0°C) (C6h: int. comp. 0°C)	+20700 0 ... +18200 -1200	32766 320 ... 27865 -1840	23432 2732 ... 20932 1532	overrange nominal range underrange
Type C:	+25000	32766	23432	overrange

Measuring ranges and function numbers

Measuring range (funct. no.)	Measuring value in °C (0.1°C/digit)	Measuring value in °F (0.1°F/digit)	Measuring value in K (0.1K/digit)	Range
[WRe5-WRe26] 0 ... +2315°C 32 ... 2786.5°F 273.2 ... 2093.2K (B7h: ext. comp. 0°C) (C7h: int. comp. 0°C)	0 ... +23150	320 ... 27865	2732 ... 20932	nominal range
	-1200	-1840	1532	underrange
Type E: [Ni-Cr - Cu-Ni] -270 ... +1000°C -454 ... 1832°F 0 ... 1273.2K (B8h: ext. comp. 0°C) (C8h: int. comp. 0°C)	+12000	21920	14732	overrange
	-2700 ... +10000	-4540 ... 18320	0 ... 12732	nominal range
	---	---	---	underrange
Type L: [Fe-Cu-Ni] -200 ... +900°C -328 ... 1652°F 73.2 ... 1173.2K (B9h: ext. comp. 0°C) (C9h: int. comp. 0°C)	+11500	21020	14232	overrange
	-2000 ... +9000	-3280 ... 16520	732 ... 11732	nominal range
	---	---	---	underrange

3.4 M31-1CD50 - AI 4 x 16Bit U, I, RTD, TC

Properties

The electronic module has 4 inputs for measuring with parameterizable functions. The channels of the module are isolated to the backplane bus.

- 4 analog inputs
- Voltage measuring
 - Suited for sensors with $\pm 10V$, 0 ... 10V
- Current measuring
 - Suited for sensors with 0 ... 20mA
 - 4 ... 20mA with external supply
- RTD
 - Suited for resistance-type sensors
0...3000 Ohm: 2, 3 or 4 wire
 - Resistance temperature sensors
Pt100, Pt1000, NI100, NI1000: 2, 3 or 4 wire
- TC
 - Suited for sensors with type
Typ J, K, N, R, S, T, B, C, E, L
 - Voltage measuring
Suited for sensors with $\pm 80mV$
- Interrupt and diagnostics function
- 16bit resolution



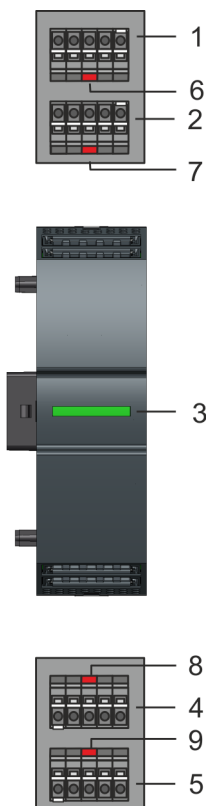

Structure







- 1 X2: Terminal channel 1
- 2 X1: Terminal channel 0
- 3 Status bar periphery module
- 4 X3: Terminal channel 2
- 5 X4: Terminal channel 3
- 6 X2 AI 1: LED Error channel 1
- 7 X1 AI 0: LED Error channel 0
- 8 X3 AI 2: LED Error channel 2
- 9 X4 AI 3: LED Error channel 3

M31-1CD50 - AI 4 x 16Bit U, I, RTD, TC

Status bar

LED	Description
	LEDs green on: Backplane bus communication and module status are OK
	LED red on: Module reports an error
	LED red blinks with 1Hz: Error in configuration
	LEDs green are blinking with 1Hz: Error backplane bus communication

LEDs connectors

Pin		LED	Description
X2	AI Channel 1	 red	Error channel x
X1	AI Channel 0	 red	<ul style="list-style-type: none"> ■ Signal leaves measuring range ■ Error in parameterization ■ Wire break (RTD and TC, if parameterized)
X3	AI Channel 2	 red	
X4	AI Channel 3	 red	

Pin assignment

X2: Channel 1	Pin 5: RTD	Pin 4: TC	Pin 3: U/I +	Pin 2: -	Pin 1: M1
	-	-	V +	V -	-
	-	-	A +	A -	-
	-	TC +	-	TC -	-
	RTD2 +	-	-	-	RTD2 -
	RTD3 +	RTD3 +	-	RTD3 - *	RTD3 -
	RTD4 +	RTD4 +	-	RTD4 -	RTD4 -

X1: Channel 0	Pin 5: RTD	Pin 4: TC	Pin 3: U/I +	Pin 2: -	Pin 1: M0
	-	-	V +	V -	-
	-	-	A +	A -	-
	-	TC +	-	TC -	-
	RTD2 +	-	-	-	RTD2 -
	RTD3 +	RTD3 +	-	RTD3 - *	RTD3 -
	RTD4 +	RTD4 +	-	RTD4 -	RTD4 -

X3: Channel 2	Pin 1: M2	Pin 2: -	Pin 3: U/I +	Pin 4: TC	Pin 5: RTD
	-	V -	V +	-	-
	-	A -	A +	-	-
	-	TC -	-	TC +	-
	RTD2 -	-	-	-	RTD2 +
	RTD3 -	RTD3 - *	-	RTD3 +	RTD3 +
	RTD4 -	RTD4 -	-	RTD4 +	RTD4 +

X4: Channel 3	Pin 1: M3	Pin 2: -	Pin 3: U/I +	Pin 4: TC	Pin 5: RTD
	-	V -	V +	-	-
	-	A -	A +	-	-
	-	TC -	-	TC +	-
	RTD2 -	-	-	-	RTD2 +
	RTD3 -	RTD3 - *	-	RTD3 +	RTD3 +
	RTD4 -	RTD4 -	-	RTD4 +	RTD4 +

*) For 3-wire measurement, pin 1 and pin 2 are to be bridged.



*Please take care of the correct polarity when installing the sensors!
Please install short circuits at non-used inputs by connecting the positive contact with the channel ground of the according channel.*

**3/4-wire measurement**

For 3-wire measurement (RTD3), it is assumed that all 3 wires have the same resistance, while for 4-wire measurement (RTD4), the resistances of the wires are individually measured and taken into account.

Supplementation to the installation guidelines TC

To avoid variations in temperature within the module, which may affect the accuracy of the temperature measurement, you should consider the following points when assembling:

- The module should be in a static condition, i.e. the temperature should be as constant as possible in the environment of your module. Installation horizontally suspended in the closed switchgear cabinet without forced ventilation.
- The accuracy is reached after approx. 30 minutes after entering the static condition.

Input area

Addr.	PIQ	Bytes	Function
+0	AI 0	2	Analog value channel 0
+2	AI 1	2	Analog value channel 1
+4	AI 2	2	Analog value channel 2
+6	AI 3	2	Analog value channel 3

Output area

No byte of the output area is used by the module.

3.4.1 Parameter data

DS - Record set for access via CPU, PROFIBUS and PROFINET

Name	Bytes	Function	Default	DS
DIAG_EN	1	Diagnostics*	00h	00h
WIBRK_EN	1	Wire break recognition (only RTD and TC)*	00h	00h
LIMIT_EN	1	Limit value monitoring*	00h	00h
RES3	1	reserved	00h	00h
TEMPCNF	1	Temperature system	00h	01h
SUPR	1	Interference frequency suppression (SFU)	02h	01h
RES6	1	reserved	00h	01h
RES7	1	reserved	00h	01h
CH0FN	1	Function number channel 0	10h	80h
CH0FO	1	Function option channel 0	02h	80h
CH0UL	2	Upper limit value channel 0	7FFFh	80h
CH0LL	2	Lower limit value channel 0	8000h	80h
CH1FN	1	Function number channel 1	10h	81h
CH1FO	1	Function option channel 1	02h	81h
CH1UL	2	Upper limit value channel 1	7FFFh	81h
CH1LL	2	Lower limit value channel 1	8000h	81h
CH2FN	1	Function number channel 2	10h	82h
CH2FO	1	Function option channel 2	02h	82h
CH2UL	2	Upper limit value channel 2	7FFFh	82h
CH2LL	2	Lower limit value channel 2	8000h	82h
CH3FN	1	Function number channel 3	10h	83h
CH3FO	1	Function option channel 3	02h	83h
CH3UL	2	Upper limit value channel 3	7FFFh	83h
CH3LL	2	Lower limit value channel 3	8000h	83h

* This record set may only be transferred at STOP state.

DIAG_EN Diagnostic interrupt

Byte	Bit 7 ... 0
0	<ul style="list-style-type: none"> ■ Diagnostic interrupt <ul style="list-style-type: none"> – 00h: disabled – 40h: enabled

■ Here you can enable respectively disable the diagnostic interrupt.

WIBRK_EN Wire-break recognition

Byte	Bit 7 ... 0
0	<ul style="list-style-type: none"> ■ Bit 0: Wire-break recognition channel 0 (1: on) ■ Bit 1: Wire-break recognition channel 1 (1: on) ■ Bit 2: Wire-break recognition channel 2 (1: on) ■ Bit 3: Wire-break recognition channel 3 (1: on) ■ Bit 7 ... 4: reserved



Wire-break recognition is only possible with RTD and TC!



Due to the high sensitivity of the inputs, unused inputs should be deactivated in the parametrization. Due to the high input impedance, open inputs can be influenced by adjacent channels or due to the measuring method during wire break detection. Since the entire measuring range moves in the mV range, open-loop inputs can already cause measuring range overshoots.

LIMIT_EN Limit value monitoring

Byte	Bit 7 ... 0
0	<ul style="list-style-type: none"> ■ Bit 0: Limit value monitoring channel 0 (1: on) ■ Bit 1: Limit value monitoring channel 1 (1: on) ■ Bit 2: Limit value monitoring channel 2 (1: on) ■ Bit 3: Limit value monitoring channel 3 (1: on) ■ Bit 7 ... 4: reserved

TEMPCNF Temperature system

Byte	Bit 7 ... 0
0	Temperature system <ul style="list-style-type: none"> ■ Bit 0, 1: Channel 0 ■ Bit 2, 3: Channel 1 ■ Bit 4, 5: Channel 2 ■ Bit 6, 7: Channel 3 – 00: °C – 01: °F – 10: K

SUPR Interference frequency suppression (SFU)

Byte	Bit 7 ... 0
0	Interference frequency suppression <ul style="list-style-type: none"> ■ Bit 0, 1: Channel 0 ■ Bit 2, 3: Channel 1 ■ Bit 4, 5: Channel 2 ■ Bit 6, 7: Channel 3 – 00: deactivated – 01: 60Hz – 10: 50Hz (Default) – 11: reserved



For RTD and TC input channels the deactivation of the interference frequency suppression is not possible! If the channel is deactivated, the SFU default value for this channel is automatically used!

CHxFN Function number channel x

In the following there are the measuring ranges with corresponding function number listed, which were supported by the analog module. The formulas listed here allow you to transform an evaluated measuring value (analog value) to a value assigned to the measuring range (digital value) and vice versa.



With FFh the corresponding channel is deactivated.

Voltage

0 ... 10V

Meas. range (funct. no.)	Voltage (U)	Decimal (D)	Hex	Range	Formulas
0 ... 10V Siemens S7 format (10h)	11.76V	32511	7EFFh	overrange	$D = 27648 \cdot \frac{U}{10}$ $U = D \cdot \frac{10}{27648}$
	10V	27648	6C00h	nominal range	
	5V	13824	3600h		
	0V	0	0000h		
	-1.76V	-4864	ED00h	underrange	
0 ... 10V Siemens S5 format (20h)	12.5V	20480	5000h	overrange	$D = 16384 \cdot \frac{U}{10}$ $U = D \cdot \frac{10}{16384}$
	10V	16384	4000h	nominal range	
	5V	8192	2000h		
	0V	0	0000h		
	-2V	-3277	F333h	underrange	

M31-1CD50 - AI 4 x 16Bit U, I, RTD, TC > Parameter data

Voltage**±10V**

Meas. range (funct. no.)	Voltage (U)	Decimal (D)	Hex	Range	Formulas
±10V Siemens S7 format (12h)	11.76V	32511	7EFFh	overrange	$D = 27648 \cdot \frac{U}{10}$ $U = D \cdot \frac{10}{27648}$
	10V	27648	6C00h	nominal range	
	5V	13824	3600h		
	0V	0	0000h		
	-5V	-13824	CA00h		
	-10V	-27648	9400h	underrange	
	-11.76V	-32512	8100h		
±10V Siemens S5 format (22h)	12.5V	20480	5000h	overrange	$D = 16384 \cdot \frac{U}{10}$ $U = D \cdot \frac{10}{16384}$
	10V	16384	4000h	nominal range	
	5V	8192	2000h		
	0V	0	0000h		
	-5V	-8192	E000h		
	-10V	-16384	C000h	underrange	
	-12.5V	-20480	B000h		

Current

0(4) ... 20mA

Meas. range (funct. no.)	Current (I)	Decimal (D)	Hex	Range	Formulas
0 ... 20mA Siemens S7 format (31h)	23.52mA	32511	7EFFh	overrange	$D = 27648 \cdot \frac{I}{20}$ $I = D \cdot \frac{20}{27648}$
	20mA	27648	6C00h	nominal range	
	10mA	13824	3600h		
	0mA	0	0000h		
	-3.52mA	-4864	ED00h	underrange	
0 ... 20mA Siemens S5 format (41h)	25.00mA	20480	5000h	overrange	$D = 16384 \cdot \frac{I}{20}$ $I = D \cdot \frac{20}{16384}$
	20mA	16384	4000h	nominal range	
	10mA	8192	2000h		
	0mA	0	0000h		
	-4,00mA	-3277	F333h	underrange	
4 ... 20mA Siemens S7 format (30h)	22.81mA	32511	7EFFh	overrange	$D = 27648 \cdot \frac{I-4}{16}$ $I = D \cdot \frac{16}{27648} + 4$
	20mA	27648	6C00h	nominal range	
	12mA	13824	3600h		
	4mA	0	0000h		
	1.19mA	-4864	ED00h	underrange	
4 ... 20mA Siemens S5 format (40h)	24.00mA	20480	5000h	overrange	$D = 16384 \cdot \frac{I-4}{16}$ $I = D \cdot \frac{16}{16384} + 4$
	20mA	16384	4000h	nominal range	
	12mA	8192	2000h		
	4mA	0	0000h		
	0.8mA	-3277	F333h	underrange	

RTD

Measuring range (funct. no.)	Measuring value	Signal range	Range
2 wire: PT100 (50h)	+1000°C	+10000	overrange
	-200 ... +850°C	-2000 ... +8500	nominal range
	-243°C	-2430	underrange
2 wire: PT1000 (51h)	+1000°C	+10000	overrange
	-200 ... +850°C	-2000 ... +8500	nominal range
	-243°C	-2430	underrange
2 wire: NI100 (52h)	+295°C	+2950	overrange
	-60 ... +250°C	-600 ... +2500	nominal range
	-105°C	-1050	underrange

M31-1CD50 - AI 4 x 16Bit U, I, RTD, TC > Parameter data

Measuring range (funct. no.)	Measuring value	Signal range	Range
2 wire: NI1000 (53h)	+295°C	+2950	overrange
	-60 ... +250°C	-600 ... +2500	nominal range
	-105°C	-1050	underrange
3 wire: PT100 (58h)	+1000°C	+10000	overrange
	-200 ... +850°C	-2000 ... +8500	nominal range
	-243°C	-2430	underrange
3 wire: PT1000 (59h)	+1000°C	+10000	overrange
	-200 ... +850°C	-2000 ... +8500	nominal range
	-243°C	-2430	underrange
3 wire: NI100 (5Ah)	+295°C	+2950	overrange
	-60 ... +250°C	-600 ... +2500	nominal range
	-105°C	-1050	underrange
3 wire: NI1000 (5Bh)	+295°C	+2950	overrange
	-60 ... +250°C	-600 ... +2500	nominal range
	-105°C	-1050	underrange
4 wire: PT100 (60h)	+1000°C	+10000	overrange
	-200 ... +850°C	-2000 ... +8500	nominal range
	-243°C	-2430	underrange
4 wire: PT1000 (61h)	+1000°C	+10000	overrange
	-200 ... +850°C	-2000 ... +8500	nominal range
	-243°C	-2430	underrange
4 wire: NI100 (62h)	+295°C	+2950	overrange
	-60 ... +250°C	-600 ... +2500	nominal range
	-105°C	-1050	underrange
4 wire: NI1000 (63h)	+295°C	+2950	overrange
	-60 ... +250°C	-600 ... +2500	nominal range
	-105°C	-1050	underrange
2 wire: 0 ... 60Ω (70h)	---	---	overrange
	0 ... 60Ω	0 ... 32767	nominal range
	---	---	underrange
2 wire: 0 ... 600Ω (71h)	---	---	overrange
	0 ... 600Ω	0 ... 32767	nominal range
	---	---	underrange
2 wire: 0 ... 3000Ω (72h)	---	---	overrange
	0 ... 3000Ω	0 ... 32767	nominal range

Measuring range (funct. no.)	Measuring value	Signal range	Range
	---	---	underrange
3 wire: 0 ... 60Ω (78h)	---	---	overrange
	0 ... 60Ω	0 ... 32767	nominal range
	---	---	underrange
3 wire: 0 ... 600Ω (79h)	---	---	overrange
	0 ... 600Ω	0 ... 32767	nominal range
	---	---	underrange
3 wire: 0 ... 3000Ω (7Ah)	---	---	overrange
	0 ... 3000Ω	0 ... 32767	nominal range
	---	---	underrange
4 wire: 0 ... 60Ω (80h)	---	---	overrange
	0 ... 60Ω	0 ... 32767	nominal range
	---	---	underrange
4 wire: 0 ... 600Ω (81h)	---	---	overrange
	0 ... 600Ω	0 ... 32767	nominal range
	---	---	underrange
4 wire: 0 ... 3000Ω (82h)	---	---	overrange
	0 ... 3000Ω	0 ... 32767	nominal range
	---	---	underrange
2 wire: 0 ... 60Ω (90h)	---	---	overrange
	0 ... 60Ω	0 ... 6000	nominal range
	---	---	underrange
2 wire: 0 ... 600Ω (91h)	---	---	overrange
	0 ... 600Ω	0 ... 6000	nominal range
	---	---	underrange
2 wire: 0 ... 3000Ω (92h)	---	---	overrange
	0 ... 3000Ω	0 ... 30000	nominal range
	---	---	underrange
3 wire: 0 ... 60Ω (98h)	---	---	overrange
	0 ... 60Ω	0 ... 6000	nominal range
	---	---	underrange
3 wire: 0 ... 600Ω (99h)	---	---	overrange
	0 ... 600Ω	0 ... 6000	nominal range
	---	---	underrange
3 wire: 0 ... 3000Ω	---	---	overrange

M31-1CD50 - AI 4 x 16Bit U, I, RTD, TC > Parameter data

Measuring range (funct. no.)	Measuring value	Signal range	Range
(9Ah)	0 ... 3000Ω	0 ... 30000	nominal range
	---	---	underrange
4 wire: 0 ... 60Ω (A0h)	---	---	overrange
	0 ... 60Ω	0 ... 6000	nominal range
4 wire: 0 ... 600Ω (A1h)	---	---	underrange
	0 ... 600Ω	0 ... 6000	nominal range
4 wire: 0 ... 3000Ω (A2h)	---	---	overrange
	0 ... 3000Ω	0 ... 30000	nominal range
2 wire: 0 ... 60Ω (D0h)	---	---	underrange
	70.55Ω	32511	overrange
2 wire: 0 ... 600Ω (D1h)	0 ... 60Ω	0 ... 27648	nominal range
	---	---	underrange
2 wire: 0 ... 600Ω (D2h)	705.5Ω	32511	overrange
	0 ... 600Ω	0 ... 27648	nominal range
2 wire: 0 ... 3000Ω (D3h)	---	---	underrange
	3528Ω	32511	overrange
3 wire: 0 ... 60Ω (D8h)	0 ... 3000Ω	0 ... 27648	nominal range
	---	---	underrange
3 wire: 0 ... 600Ω (D9h)	70.55Ω	32511	overrange
	0 ... 60Ω	0 ... 27648	nominal range
3 wire: 0 ... 600Ω (D9h)	---	---	underrange
	705.5Ω	32511	overrange
3 wire: 0 ... 3000Ω (DAh)	0 ... 600Ω	0 ... 27648	nominal range
	---	---	underrange
4 wire: 0 ... 60Ω (E0h)	3528Ω	32511	overrange
	0 ... 3000Ω	0 ... 27648	nominal range
4 wire: 0 ... 60Ω (E0h)	---	---	underrange
	70.55Ω	32511	overrange
4 wire: 0 ... 600Ω (E1h)	0 ... 60Ω	0 ... 27648	nominal range
	---	---	underrange
4 wire: 0 ... 600Ω (E1h)	705.5Ω	32511	overrange
	0 ... 600Ω	0 ... 27648	nominal range
4 wire: 0 ... 600Ω (E1h)	---	---	underrange

Measuring range (funct. no.)	Measuring value	Signal range	Range
4 wire: 0 ... 3000Ω (E2h)	3528Ω	32511	overrange
	0 ... 3000Ω	0 ... 27648	nominal range
	---	---	underrange

TC

-80 ... 80mV

Meas. range (funct. no.)	Voltage (U)	Decimal (D)	Hex	Range	Formulas
-80 ... 80mV Siemens S7 format (11h)	94.07mV	32511	7EFFh	overrange	$D = 27648 \cdot \frac{U}{80}$ $U = D \cdot \frac{80}{27648}$
	80mV	27648	6C00h	nominal range	
	0V	0	0000h		
	-80mV	-27648	9400h		
	-94.07mV	-32512	8100h	underrange	
-80 ... 80mV Siemens S5 format (21h)	100mV	20480	5000h	overrange	$D = 16384 \cdot \frac{U}{80}$ $U = D \cdot \frac{80}{16384}$
	80mV	16384	4000h	nominal range	
	0V	0	0000h		
	-80mV	-16384	C000h		
	-100mV	-20480	B000h	underrange	

TC

Temperature

Measuring range (funct. no.)	Measuring value in °C (0.1°C/digit)	Measuring value in °F (0.1°F/digit)	Measuring value in K (0.1K/digit)	Range
Type J: [Fe-Cu-Ni IEC] -210 ... +1200°C -346 ... 2192°F 63.2 ... 1473.2K (B0h: ext. comp. 0°C) (C0h: int. comp. 0°C)	+14500	26420	17232	overrange
	-2100 ... +12000	-3460 ... 21920	632 ... 14732	nominal range
	---	---	---	underrange
Type K: [Ni-Cr-Ni] -270 ... +1372°C -454 ... 2501.6°F 0 ... 1645.2K (B1h: ext. comp. 0°C)	+16220	29516	18952	overrange
	-2700 ... +13720	-4540 ... 25016	0 ... 16452	nominal range

M31-1CD50 - AI 4 x 16Bit U, I, RTD, TC > Parameter data

Measuring range (funct. no.)	Measuring value in °C (0.1°C/digit)	Measuring value in °F (0.1°F/digit)	Measuring value in K (0.1K/digit)	Range
(C1h: int. comp. 0°C)	---	---	---	underrange
Type N: [Ni-Cr-Si] -270 ... +1300°C -454 ... 2372°F 0 ... 1573.2K (B2h: ext. comp. 0°C) (C2h: int. comp. 0°C)	+15500 -2700 ... +13000 ---	28220 -4540 ... 23720 ---	18232 0 ... 15732 ---	overrange nominal range underrange
Type R: [PtRh-Pt] -50 ... +1769°C -58 ... 3216.2°F 223.2 ... 2042.2K (B3h: ext. comp. 0°C) (C3h: int. comp. 0°C)	+20190 -500 ... +17690 -1700	32766 -580 ... 32162 -2740	22922 2232 ... 20422 1032	overrange nominal range underrange
Type S: [PtRh-Pt] -50 ... +1769°C -58 ... 3216.2°F 223.2 ... 2042.2K (B4h: ext. comp. 0°C) (C4h: int. comp. 0°C)	+20190 -500 ... +17690 -1700	32766 -580 ... 32162 -2740	22922 2232 ... 20422 1032	overrange nominal range underrange
Type T: [Cu-Cu-Ni] -270 ... +400°C -454 ... 752°F 3.2 ... 673.2K (B5h: ext. comp. 0°C) (C5h: int. comp. 0°C)	+5400 -2700 ... +4000 ---	10040 -4540 ... 7520 ---	8132 32 ... 6732 ---	overrange nominal range underrange
Type B: [PtRh-PtRh] 0 ... +1820°C 32 ... 2786.5°F 273.2 ... 2093.2K (B6h: ext. comp. 0°C) (C6h: int. comp. 0°C)	+20700 0 ... +18200 -1200	32766 320 ... 27865 -1840	23432 2732 ... 20932 1532	overrange nominal range underrange
Type C:	+25000	32766	23432	overrange

Measuring range (funct. no.)	Measuring value in °C (0.1°C/digit)	Measuring value in °F (0.1°F/digit)	Measuring value in K (0.1K/digit)	Range
[WRe5-WRe26] 0 ... +2315°C 32 ... 2786.5°F 273.2 ... 2093.2K (B7h: ext. comp. 0°C) (C7h: int. comp. 0°C)	0 ... +23150	320 ... 27865	2732 ... 20932	nominal range
	-1200	-1840	1532	underrange
Type E: [Ni-Cr - Cu-Ni] -270 ... +1000°C -454 ... 1832°F 0 ... 1273.2K (B8h: ext. comp. 0°C) (C8h: int. comp. 0°C)	+12000	21920	14732	overrange
	-2700 ... +10000	-4540 ... 18320	0 ... 12732	nominal range
	---	---	---	underrange
Type L: [Fe-Cu-Ni] -200 ... +900°C -328 ... 1652°F 73.2 ... 1173.2K (B9h: ext. comp. 0°C) (C9h: int. comp. 0°C)	+11500	21020	14232	overrange
	-2000 ... +9000	-3280 ... 16520	732 ... 11732	nominal range
	---	---	---	underrange

**CHxFO Function option
channel x**

Depending on the Interference frequency suppression for each channel the transducer velocity may be set.

Code	Measuring range	Velocity (in ms) / channel at interference frequency suppression	
		50Hz	60Hz
	U/I	30 (16bit)	30 (16bit)
01h ²	RTD / TC ±80mV	200 (16bit)	200 (16bit)
02h ^{1,2}		100 (16bit)	100 (16bit)
03h		-	40 (16bit)
04h		-	34 (16bit)
05h		-	20 (15bit)
06h		-	17 (14bit)
07h		-	10 (13bit)

1) Default

2) For Code 01h and 02h the tolerances of the technical data "with interference frequency suppression" are valid.

CHxUL / CHxLL Channel x For each channel an *upper* and a *lower limit* may be defined. By presetting 7FFFh for the upper respectively 8000h for the lower limit value the corresponding limit is deactivated. If an adjusted limit value is outside the allowed range, no process interrupt is initialized, but the limit will never be reached.

3.4.2 Diagnostics and interrupt

Event	Process interrupt	Diagnostics interrupt	parameterizable
Error in project engineering/param.	-	X	-
Wire break (only RTD and TC)	-	X	X
Measuring range overflow	-	X	-
Measuring range underflow	-	X	-
Limit overflow	X	-	X
Limit underflow	X	-	X
Diagnostic buffer overflow	-	X	-
Communication error	-	X	-
Process interrupt lost	-	X	-

Process interrupt

So you may react to asynchronous events, there is the possibility to activate a process interrupt. A process interrupt interrupts the linear program sequence and jumps depending on the master system to a corresponding Interrupt routine. Here you can react to the process interrupt accordingly.

Operating with CPU, PROFIBUS and PROFINET the process interrupt data were transferred via diagnostics telegram.

Name	Bytes	Function	Default
PRIT_OL	1	Limit overflow channel x	00h
PRIT_UL	1	Limit underflow channel x	00h
PRIT_US	2	µs-Ticker	00h

PRIT_OL Limit overflow

Byte	Bit 7 ... 0
0	<ul style="list-style-type: none"> ■ Bit 0: Limit overflow channel 0 ■ Bit 1: Limit overflow channel 1 ■ Bit 2: Limit overflow channel 2 ■ Bit 3: Limit overflow channel 3 ■ Bit 7 ... 4: reserved

PRIT_UL Limit underflow

Byte	Bit 7 ... 0
0	<ul style="list-style-type: none"> ■ Bit 0: Limit underflow channel 0 ■ Bit 1: Limit underflow channel 1 ■ Bit 2: Limit underflow channel 2 ■ Bit 3: Limit underflow channel 3 ■ Bit 7 ... 4: reserved

PRIT_US μ s ticker

Byte	Bit 7 ... 0
0 ... 1	16bit μ s value at the moment of the interrupt

 μ s ticker

In the module there is a 32 bit timer (μ s ticker). With PowerON the timer starts counting with 0. After $2^{32}-1\mu$ s the timer starts with 0 again. PRIT_US represents the lower 2 byte of the μ s ticker value (0 ... $2^{16}-1$).

Diagnostic data

The diagnostics data serves information about this module. On error the corresponding channel LED of the module is activated and the error is registered in the diagnostics data.

The following errors are listed in the diagnostics data:

- Error in project engineering / parameterization
- Wire-break only RTD and TC (if parameterized)
- External auxiliary supply missing

DS - Record set for access via CPU, PROFIBUS and PROFINET. The access happens by DS 01h. Additionally the first 4 bytes may be accessed by DS 00h.

Name	Bytes	Function	Default	DS
ERR_A	1	Diagnostic	00h	01h
MODTYP	1	Module information	15h	
RES2	1	reserved	00h	
ERR_D	1	Diagnostic	00h	
CHTYP	1	Channel type	71h	
NUMBIT	1	Number diagnostic bits per channel	08h	
NUMCH	1	Number of channels of a module	02h	
CHERR	1	Channel error	00h	
CH0ERR	1	Channel-specific error channel 0	00h	
CH1ERR	1	Channel-specific error channel 1	00h	
CH2ERR	1	Channel-specific error channel 2	00h	
CH3ERR	1	Channel-specific error channel 3	00h	
CH4ERR... CH7ERR	4	reserved	00h	
DIAG_US	4	μ s ticker	00h	

ERR_A Diagnostic

Byte	Bit 7 ... 0
0	<ul style="list-style-type: none"> ■ Bit 0: set at module failure ■ Bit 1: set at internal error ■ Bit 2: set at external error ■ Bit 3: set at channel error ■ Bit 6 ... 4: reserved ■ Bit 7: set at error in parameterization

MODTYP Module information

Byte	Bit 7 ... 0
0	<ul style="list-style-type: none"> ■ Bit 3 ... 0: module class <ul style="list-style-type: none"> – 0101b: Analog module ■ Bit 4: Channel information available ■ Bit 7 ... 5: reserved

ERR_D Diagnostic

Byte	Bit 7 ... 0
0	<ul style="list-style-type: none"> ■ Bit 3 ... 0: reserved ■ Bit 4: set at internal communication error ■ Bit 5: reserved ■ Bit 6: process interrupt lost ■ Bit 7: reserved

CHTYP Channel type

Byte	Bit 7 ... 0
0	<ul style="list-style-type: none"> ■ Bit 6 ... 0: Channel type <ul style="list-style-type: none"> – 71h: Analog input ■ Bit 7: reserved

NUMBIT Diagnostic bits

Byte	Bit 7 ... 0
0	Number of diagnostic bits per channel (here 08h)

NUMCH Channels

Byte	Bit 7 ... 0
0	Number of channels of the module (here 04h)

CHERR Channel error

Byte	Bit 7 ... 0
0	<ul style="list-style-type: none"> ■ Bit 0: set at error in channel group 0 ■ Bit 1: set at error in channel group 1 ■ Bit 2: set at error in channel group 2 ■ Bit 3: set at error in channel group 3 ■ Bit 7 ... 4: reserved

CHxERR Channel-specific

Byte	Bit 7 ... 0
0	Channel-specific error: Channel x: <ul style="list-style-type: none"> ■ Bit 0: set at project engineering/parameterization error ■ Bit 3 ... 1: reserved ■ Bit 4: set at wire break (only RTD and TC) ■ Bit 5: set at process interrupt lost ■ Bit 6: set at measuring range underflow ■ Bit 7: set at measuring range overflow

DIAG_US μ s ticker

Byte	Bit 7 ... 0
0...3	Value of the μ s ticker at the moment of the diagnostic <ul style="list-style-type: none"> ■ In the System MICRO module there is a timer (μs ticker). With PowerON the timer starts counting with 0. After $2^{32}-1\mu$s the timer starts with 0 again.

3.4.3 Technical data

Order no.	M31-1CD50
Type	SM M31
Module ID	0417 1544
Current consumption/power loss	
Current consumption from backplane bus	150 mA
Power loss	750 mW
Technical data analog inputs	
Number of inputs	4
Cable length, shielded	200 m
Rated load voltage	-
Current consumption from load voltage L+ (without load)	-
Voltage inputs	✓
Min. input resistance (voltage range)	100 kΩ
Input voltage ranges	0 V ... +10 V -10 V ... +10 V -80 mV ... +80 mV
Operational limit of voltage ranges	+/-0.3%
Operational limit of voltage ranges with SFU	+/-0.3%
Basic error limit voltage ranges	+/-0.2%
Basic error limit voltage ranges with SFU	+/-0.2%
Destruction limit voltage	max. 30V
Current inputs	✓
Max. input resistance (current range)	70 Ω
Input current ranges	0 mA ... +20 mA +4 mA ... +20 mA
Operational limit of current ranges	+/-0.3%
Operational limit of current ranges with SFU	+/-0.3%
Basic error limit current ranges	+/-0.2%
Radical error limit current ranges with SFU	+/-0.2%
Destruction limit current inputs (voltage)	max. 30V
Destruction limit current inputs (electrical current)	max. 60mA
Resistance inputs	✓
Resistance ranges	0 ... 60 Ohm 0 ... 600 Ohm 0 ... 3000 Ohm
Operational limit of resistor ranges	+/-0.3%

Order no.	M31-1CD50
Operational limit of resistor ranges with SFU	+/-0.3%
Basic error limit	+/-0.2%
Basic error limit with SFU	+/-0.2%
Destruction limit resistance inputs	max. 30V
Resistance thermometer inputs	✓
Resistance thermometer ranges	Pt100 Pt1000 Ni100 Ni1000
Operational limit of resistance thermometer ranges	+/-0.3%
Operational limit of resistance thermometer ranges with SFU	+/-0.3%
Basic error limit thermoresistor ranges	+/-0.2%
Basic error limit thermoresistor ranges with SFU	+/-0.2%
Destruction limit resistance thermometer inputs	max. 30V
Thermocouple inputs	✓
Thermocouple ranges	type J type L type K type N type R type S type B type C type E type T
Operational limit of thermocouple ranges	for type B: +/-14.6K; for type K, Typ N: +/-10.0K; for type S, Typ R: +/-14.1K; for type T: +/-12.0K; for type C: +/-14.0K; for type E: +/-13.0K; for type J: +/-11.0K; for type L: +/-13.5K

Order no.	M31-1CD50
Operational limit of thermocouple ranges with SFU	for type B: +/-14.6K; for type K, Typ N: +/-10.0K; for type S, Typ R: +/-14.1K; for type T: +/-12.0K; for type C: +/-14.0K; for type E: +/-13.0K; for type J: +/-11.0K; for type L: +/-13.5K
Basic error limit thermoelement ranges	for type B: +/-14.6K; for type K, Typ N: +/-10.0K; for type S, Typ R: +/-14.1K; for type T: +/-12.0K; for type C: +/-14.0K; for type E: +/-13.0K; for type J: +/-11.0K; for type L: +/-13.5K
Basic error limit thermoelement ranges with SFU	for type B: +/-14.6K; for type K, Typ N: +/-10.0K; for type S, Typ R: +/-14.1K; for type T: +/-12.0K; for type C: +/-14.0K; for type E: +/-13.0K; for type J: +/-11.0K; for type L: +/-13.5K
Destruction limit thermocouple inputs	max. 30V
Programmable temperature compensation	-
External temperature compensation	-
Internal temperature compensation	✓
Temperature error internal compensation	8 K
Technical unit of temperature measurement	°C, °F, K
Resolution in bit	16
Measurement principle	Sigma-Delta
Basic conversion time	10ms ... 200ms (for R/RTD & TC)
Noise suppression for frequency	>80dB (UCM <3,2V)
Status information, alarms, diagnostics	
Status display	Bicolour green/red LED
Interrupts	yes, parameterizable
Process alarm	yes, parameterizable

Order no.	M31-1CD50
Diagnostic interrupt	yes, parameterizable
Diagnostic functions	yes, parameterizable
Diagnostics information read-out	possible
Module state	none
Module error display	Bicolour green/red LED
Channel error display	red LED per channel
Isolation	
Between channels	✓
Between channels of groups to	-
Between channels and backplane bus	✓
Between channels and power supply	-
Max. potential difference between circuits	-
Max. potential difference between inputs (Ucm)	DC 3 V
Max. potential difference between Mana and Mintern (Uiso)	DC 75 V/ AC 50 V
Max. potential difference between inputs and Mana (Ucm)	-
Max. potential difference between inputs and Mintern (Uiso)	-
Max. potential difference between Mintern and outputs	-
Insulation tested with	-
Datasizes	
Input bytes	8
Output bytes	0
Parameter bytes	32
Diagnostic bytes	20
Housing	
Material	PPE / PPE GF10
Mounting	Profile rail 35 mm
Mechanical data	
Dimensions (WxHxD)	26 mm x 88 mm x 71 mm
Net weight	88 g
Weight including accessories	88 g
Gross weight	105 g
Environmental conditions	
Operating temperature	0 °C to 60 °C
Storage temperature	-40 °C to 70 °C
Certifications	

Order no.	M31-1CD50
UL certification	in preparation
KC certification	in preparation

Information on error limits

The indicated error limits are valid starting from the following temperatures:

- Thermoelement type L: -100 °C
- Thermoelement type T: -90 °C
- Thermoelement type K: -60 °C
- Thermoelement type B: +70 °C
- Thermoelement type N: -80 °C
- Thermoelement type E: -150 °C
- Thermoelement type R: +200 °C
- Thermoelement type S: +100 °C
- Thermoelement type J: -140 °C

4 Analog output

4.1 General

Cabling for analog signals

You must only use screened cable when you are connecting analog signals. These cables reduce the effect of electrical interference. The screen of the analog signal cable should be grounded at both ends. In situations with different electrical potentials, it is possible that a current will flow to equalize the potential difference. This current could interfere with the analog signals. Under these circumstances it is advisable to ground the screen of the signal cable at one end only.

Connecting loads and actuators

You can use the analog output modules to supply loads and actuators with current or voltage.



Please take always care of the correct polarity when connecting actuators! Please leave the output clamps of not used channels disconnected and set the output type of the channel to "deactivated" in the hardware configurator from Siemens.

Parameterization

The parameterization via CPU, PROFIBUS and PROFINET happens by means of record sets (DS). The corresponding record set number may be found at the respective module description.

Diagnostic functions

The modules have diagnostics capability. The following errors may release a diagnostic:

- Error in parameterization
- Short-circuit recognition
- Wire-break recognition



Alternated blinking of the channel error LEDs

The alternate blinking of the channel error LEDs of channel 0 and 1 indicates a watchdog error due to a system overload. Restart with a power cycle your system. If the error occurred again, check configuration and circuit and adjust them if necessary. If the error persists, please contact our support.

4.2 Analog value

Analog value representation

The analog values are only processed in binary representation. Hereby the binary word variable is transformed into an analog process signal and put out via the corresponding channel. The analog values are displayed as a fixed-point number in the two's complement.

Resolution	Analog value - twos complement															
	High byte (byte 0)								Low byte (byte 1)							
Bit number	15	14	13	12	11	10	9	8	7	6	5	4	3	2	1	0
Value	SG	2^{14}	2^{13}	2^{12}	2^{11}	2^{10}	2^9	2^8	2^7	2^6	2^5	2^4	2^3	2^2	2^1	2^0
15Bit+SG	SG	Analog value (word)														

Sign bit (SG)

The algebraic sign bit is represented by Bit 15. Here it is essential:

- Bit 15 = "0": → positive value
- Bit 15 = "1": → negative value

4.3 Output ranges and function numbers

General

In the following there are the output ranges listed with function number, which were supported by the corresponding analog module. The here listed formulas allow you to transform a value (digital value) to an analog value and vice versa.

Output ranges

Voltage

0 ... 10V

Output range (funct. no.)	Voltage (U)	Decimal (D)	Hex	Range	Formulas
0 ... 10V Siemens S7 format (10h)	11,76V	32511	7EFFh	overrange	$U = D \times \frac{10}{27648}$ $D = 27648 \times \frac{U}{10}$
	10V	27648	6C00h	nominal range	
	5V	13824	3600h		
	0V	0	0000h		
	Not possible, is limited to 0V.				
0 ... 10V Siemens S5 format (20h)	12,5V	20480	5000h	overrange	$U = D \times \frac{10}{16384}$ $D = 16384 \times \frac{U}{10}$
	10V	16384	4000h	nominal range	
	5V	8192	2000h		
	0V	0	0000h		
	Not possible, is limited to 0V.				

±10V

Output range (funct. no.)	Voltage (U)	Decimal (D)	Hex	Range	Formulas
±10V Siemens S format (12h)	11.76V	32511	7EFFh	overrange	$U = D \times \frac{10}{27648}$ $D = 27648 \times \frac{U}{10}$
	10V	27648	6C00h	nominal range	
	5V	13824	3600h		
	0V	0	0000h		
	-5V	-13824	CA00h		
	-10V	-27648	9400h	underrange	
	-11.76V	-32512	8100h		
±10V Siemens S5 format (22h)	12.5V	20480	5000h	overrange	$U = D \times \frac{10}{16384}$ $D = 16384 \times \frac{U}{10}$
	10V	16384	4000h	nominal range	
	5V	8192	2000h		
	0V	0	0000h		
	-5V	-8192	E000h		
	-10V	-16384	C000h	underrange	
	-12.5V	-20480	B000h		

Output ranges

Current

0 ... 20mA

Output range (funct. no.)	Current (I)	Decimal (D)	Hex	Range	Formulas
0 ... 20mA Siemens S7 format (31h)	23.52mA	32511	7EFFh	overrange	$I = D \times \frac{20}{27648}$ $D = 27648 \times \frac{I}{20}$
	20mA	27648	6C00h	nominal range	
	10mA	13824	3600h		
	0mA	0	0000h		
	Not possible, is limited to 0mA.				
0 ... 20mA Siemens S5 format (41h)	25.00mA	20480	5000h	overrange	$I = D \times \frac{20}{16384}$ $D = 16384 \times \frac{I}{20}$
	20mA	16384	4000h	nominal range	
	10mA	8192	2000h		
	0mA	0	0000h		
	Not possible, is limited to 0mA.				

Output ranges and function numbers

4 ... 20mA

Output range (funct. no.)	Current (I)	Decimal (D)	Hex	Range	Formulas
4 ... 20mA Siemens S7 format (30h)	22.81mA	32511	7EFFh	overrange	$I = D \times \frac{16}{27648} + 4$ $D = 27648 \times \frac{I-4}{16}$
	20mA	27648	6C00h	nominal range	
	12mA	13824	3600h		
	4mA	0	0000h		
	0mA	-6912	E500h	underrange	
4 ... 20mA Siemens S5 format (40h)	24.00mA	20480	5000h	overrange	$I = D \times \frac{16}{16384} + 4$ $D = 16384 \times \frac{I-4}{16}$
	20mA	16384	4000h	nominal range	
	12mA	8192	2000h		
	4mA	0	0000h		
	0mA	-4096	F000h	underrange	

4.4 M32-1BD40 - AO 4 x 12Bit I

Properties

The Analog module has 4 outputs with parameterizable functions. The channels of the module are electrically isolated from the backplane bus. In addition, the channels are isolated to the DC 24V power supply by means of DC/DC converter.

- 4 analog outputs
- Suited for sensors with 0...20mA; 4...20mA
- Diagnostics function
- 12bit resolution

Structure

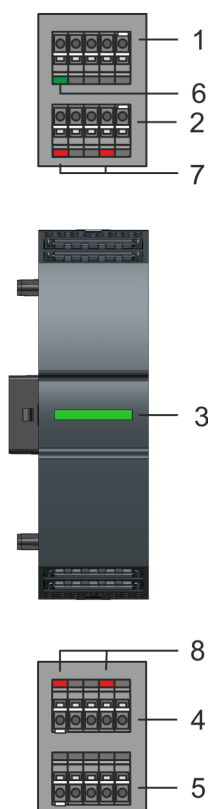

- 1 X2: Terminal (DC 24V)
- 2 X1: Terminal (AO 0, AO 1)
- 3 Status bar periphery module
- 4 X3: Terminal (AO 2, AO 3)
- 5 X4: Terminal (Shield)
- 6 X2 1L+: LED DC 24V electronic section supply
- 7 X1 AO 0, AO 1: LED channel error
- 8 X3 AO 2, AO 3: LED channel error

Status bar

LED	Description
	LEDs green on: Backplane bus communication and module status are OK
	LED red on: Module reports an error
	LED red blinks with 1Hz: Error in configuration
	LEDs green are blinking with 1Hz: Error backplane bus communication

M32-1BD40 - AO 4 x 12Bit I

LEDs connectors

Pin	Function	LED	Description
X2:5	L+	green	DC 24V electronic section supply OK
X1:5	AO 0	red	Error channel x ■ Error in parameterization ■ Wire break (if parameterized)
X1:2	AO 1	red	
X3:1	AO 2	red	
X3:4	AO 3	red	

Pin assignment

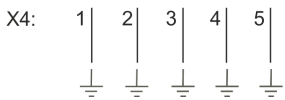
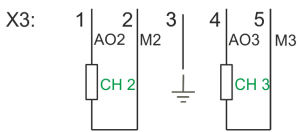
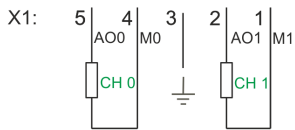
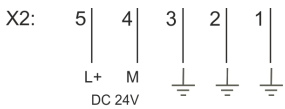

	Pin	Function	Type	LED	Description
X2:	1		O		Shield
	2		O		Shield
	3		I		Shield
	4	M	I		Ground power supply (M)
	5	L+	I	green	Power supply DC 24V (L+)
X1:	1	M1	O		Ground CH 1
	2	AO1	O	red	Analog Output CH 1
	3		O		Shield
	4	M0	O		Ground CH 0
	5	AO0	O	red	Analog Output CH 0
X3:	1	AO2	O	red	Analog Output CH 2
	2	M2	O		Ground CH 2
	3		O		Shield
	4	AO3	O	red	Analog Output CH 3
	5	M3	O		Ground CH 3
X4:	1		O		Shield
	2		O		Shield
	3		O		Shield
	4		O		Shield
	5		O		Shield

I: Input | O: Output

Input area

No byte of the input area is used by the module.

Output area

Addr.	Name	Byte	Function
+0	PIQ	0	Status of the outputs <ul style="list-style-type: none"> ■ Bit 0: Channel CH 0 ■ Bit 1: Channel CH 1 ■ Bit 2: Channel CH 2 ■ Bit 3: Channel CH 3

4.4.1 Parameter data

DS - Record set for access via CPU, PROFIBUS and PROFINET

Name	Bytes	Function	Default	DS
RES0	1	reserved	00h	00h
WIBRK_EN	1	Wire-break recognition	00h	00h
CH0FN	1	Function number channel 0	31h	80h
CH1FN	1	Function number channel 1	31h	81h
CH2FN	1	Function number channel 2	31h	82h
CH3FN	1	Function number channel 3	31h	83h

WIBRK_EN Wire-break recognition

You also can activate the wire-break recognition for the current output range 0 ... 20mA. To ensure a safe wire-break recognition, the decimal value for the output is ≥ 100 .

Byte	Bit 7 ... 0
0	<ul style="list-style-type: none"> ■ Bit 0: Wire-break recognition channel 0 (1: on) ■ Bit 1: Wire-break recognition channel 1 (1: on) ■ Bit 2: Wire-break recognition channel 2 (1: on) ■ Bit 3: Wire-break recognition channel 3 (1: on) ■ Bit 7 ... 4: reserved

CHxFN Function number channel x

In the following there are the measuring ranges with corresponding function number listed, which were supported by the analog module. With FFh the corresponding channel is deactivated. The formulas listed here allow you to transform an evaluated measuring value (digital value) to a value assigned to the measuring range (analog value) and vice versa.

0 ... 20mA

Output range (funct. no.)	Current (I)	Decimal (D)	Hex	Range	Formulas
0 ... 20mA Siemens S7 format (31h)	23.52mA	32511	7EFFh	overrange	$I = D \times \frac{20}{27648}$ $D = 27648 \times \frac{I}{20}$
	20mA	27648	6C00h	nominal range	
	10mA	13824	3600h		
	0mA	0	0000h		
	Not possible, is limited to 0mA.				
0 ... 20mA Siemens S5 format (41h)	25.00mA	20480	5000h	overrange	$I = D \times \frac{20}{16384}$ $D = 16384 \times \frac{I}{20}$
	20mA	16384	4000h	nominal range	
	10mA	8192	2000h		
	0mA	0	0000h		
	Not possible, is limited to 0mA.				

4 ... 20mA

Output range (funct. no.)	Current (I)	Decimal (D)	Hex	Range	Formulas
4 ... 20mA Siemens S7 format (30h)	22.81mA	32511	7EFFh	overrange	$I = D \times \frac{16}{27648} + 4$ $D = 27648 \times \frac{I-4}{16}$
	20mA	27648	6C00h	nominal range	
	12mA	13824	3600h		
	4mA	0	0000h		
	0mA	-6912	E500h	underrange	
4 ... 20mA Siemens S5 format (40h)	24.00mA	20480	5000h	overrange	$I = D \times \frac{16}{16384} + 4$ $D = 16384 \times \frac{I-4}{16}$
	20mA	16384	4000h	nominal range	
	12mA	8192	2000h		
	4mA	0	0000h		
	0mA	-4096	F000h	underrange	

4.4.2 Diagnostic data

So this module does not support interrupt functions, the diagnostics data serves information about this module. On error the corresponding channel LED of the module is activated and the error is registered in the diagnostics data.

The following errors are listed in the diagnostics data:

- Error in project engineering / parameterization
- Wire-break (if parameterized)
- External auxiliary supply missing

DS - Record set for access via CPU, PROFIBUS and PROFINET. The access happens by DS 01h. Additionally the first 4 bytes may be accessed by DS 00h.

Name	Bytes	Function	Default	DS
ERR_A	1	Diagnostic	00h	01h
MODTYP	1	Module information	15h	
ERR_C	1	reserved	00h	
ERR_D	1	Diagnostic	00h	
CHTYP	1	Channel type	73h	
NUMBIT	1	Number diagnostic bits per channel	08h	
NUMCH	1	Number of channels of a module	04h	
CHERR	1	Channel error	00h	
CH0ERR	1	Channel-specific error channel 0	00h	
CH1ERR	1	Channel-specific error channel 1	00h	
CH2ERR	1	Channel-specific error channel 2	00h	
CH3ERR	1	Channel-specific error channel 3	00h	
CH4ERR... CH7ERR	4	reserved	00h	
DIAG_US	4	µs ticker	00h	

ERR_A Diagnostic

Byte	Bit 7 ... 0
0	<ul style="list-style-type: none"> ■ Bit 0: set at module failure ■ Bit 1: set at internal error ■ Bit 2: set at external error ■ Bit 3: set at channel error ■ Bit 4: set at external auxiliary supply missing ■ Bit 6 ... 5: reserved ■ Bit 7: set at error in parameterization

M32-1BD40 - AO 4 x 12Bit I > Diagnostic data

MODTYP Module information

Byte	Bit 7 ... 0
0	<ul style="list-style-type: none"> ■ Bit 3 ... 0: module class <ul style="list-style-type: none"> – 0101b: Analog module ■ Bit 4: Channel information available ■ Bit 7 ... 5: reserved

ERR_D Diagnostic

Byte	Bit 7 ... 0
0	<ul style="list-style-type: none"> ■ Bit 2 ... 0: reserved ■ Bit 3: set at internal diagnostics buffer overflow ■ Bit 4: set at internal communication error ■ Bit 7 ... 5: reserved

CHTYP Channel type

Byte	Bit 7 ... 0
0	<ul style="list-style-type: none"> ■ Bit 6 ... 0: Channel type <ul style="list-style-type: none"> – 73h: Analog output ■ Bit 7: reserved

NUMBIT Diagnostic bits

Byte	Bit 7 ... 0
0	Number of diagnostic bits per channel (here 08h)

NUMCH Channels

Byte	Bit 7 ... 0
0	Number of channels of the module (here 04h)

CHERR Channel error

Byte	Bit 7 ... 0
0	<ul style="list-style-type: none"> ■ Bit 0: set at error in channel group 0 ■ Bit 1: set at error in channel group 1 ■ Bit 2: set at error in channel group 2 ■ Bit 3: set at error in channel group 3 ■ Bit 7 ... 4: reserved

CH0ERR ... CH3ERR Channel-specific

Byte	Bit 7 ... 0
0	Channel-specific error channel x: <ul style="list-style-type: none"> ■ Bit 0: set at configuring/parameter assignment error ■ Bit 3 ... 1: reserved ■ Bit 4: set at wire-break ■ Bit 7 ... 5: reserved

DIAG_US μ s ticker

Byte	Bit 7 ... 0
0...3	Value of the μ s ticker at the moment of the diagnostic <ul style="list-style-type: none">■ In the System MICRO module there is a timer (μs ticker). With PowerON the timer starts counting with 0. After $2^{32}-1\mu$s the timer starts with 0 again.

4.4.3 Technical data

Order no.	M32-1BD40
Type	SM M32 - Analog output
Module ID	0504 25E0
Current consumption/power loss	
Current consumption from backplane bus	70 mA
Power loss	0.8 W
Technical data analog outputs	
Number of outputs	4
Cable length, shielded	200 m
Rated load voltage	DC 24 V
Reverse polarity protection of rated load voltage	✓
Current consumption from load voltage L+ (without load)	-
Voltage output short-circuit protection	-
Voltage outputs	-
Min. load resistance (voltage range)	-
Max. capacitive load (current range)	-
Max. inductive load (current range)	-
Output voltage ranges	-
Operational limit of voltage ranges	-
Basic error limit voltage ranges	-
Destruction limit against external applied voltage	-
Current outputs	-
Max. in load resistance (current range)	350 Ω
Max. inductive load (current range)	10 μH
Typ. open circuit voltage current output	12 V
Output current ranges	0 mA ... +20 mA +4 mA ... +20 mA
Operational limit of current ranges	+/-0.4% ... +/-0.5%
Basic error limit current ranges	+/-0.2% ... +/-0.3%
Destruction limit against external applied voltage	max. 12V (30V for 1s)
Settling time for ohmic load	0.25 ms
Settling time for capacitive load	-
Settling time for inductive load	1.5 ms
Resolution in bit	12
Conversion time	2 ms all channels
Substitute value can be applied	no

Order no.	M32-1BD40
Output data size	8 Byte
Status information, alarms, diagnostics	
Status display	yes
Interrupts	no
Process alarm	no
Diagnostic interrupt	no
Diagnostic functions	yes
Diagnostics information read-out	possible
Supply voltage display	green LED
Group error display	Bicolour green/red LED
Channel error display	red LED per channel
Isolation	
Between channels	-
Between channels of groups to	-
Between channels and backplane bus	✓
Between channels and power supply	✓
Max. potential difference between circuits	-
Max. potential difference between inputs (Ucm)	-
Max. potential difference between Mana and Mintern (Uiso)	DC 75 V/ AC 50 V
Max. potential difference between inputs and Mana (Ucm)	-
Max. potential difference between inputs and Mintern (Uiso)	-
Max. potential difference between Mintern and outputs	-
Insulation tested with	DC 500 V
Datasizes	
Input bytes	0
Output bytes	8
Parameter bytes	10
Diagnostic bytes	20
Housing	
Material	PPE / PPE GF10
Mounting	Profile rail 35 mm
Mechanical data	
Dimensions (WxHxD)	26 mm x 88 mm x 71 mm
Net weight	94 g
Weight including accessories	94 g

M32-1BD40 - AO 4 x 12Bit I > Technical data

Order no.	M32-1BD40
Gross weight	107 g
Environmental conditions	
Operating temperature	0 °C to 60 °C
Storage temperature	-25 °C to 70 °C
Certifications	
UL certification	in preparation
KC certification	in preparation

4.5 M32-1BD70 - AO 4 x 12Bit U

Properties

The Analog module has 4 outputs with parameterizable functions. The channels of the module are electrically isolated from the backplane bus. In addition, the channels are isolated to the DC 24V power supply by means of DC/DC converter.

- 4 analog outputs
- Suited for sensors with $\pm 10V$, 0 ... 10V
- Diagnostics function
- 12bit resolution

Structure

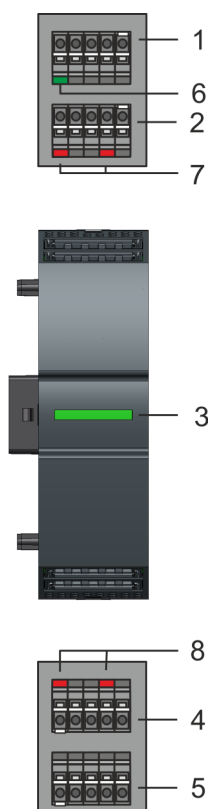

- 1 X2: Terminal (DC 24V)
- 2 X1: Terminal (AO 0, AO 1)
- 3 Status bar periphery module
- 4 X3: Terminal (AO 2, AO 3)
- 5 X4: Terminal (Shield)
- 6 X2 1L+: LED DC 24V electronic section supply
- 7 X1 AO 0, AO 1: LED channel error
- 8 X3 AO 2, AO 3: LED channel error

Status bar

LED	Description
	LEDs green on: Backplane bus communication and module status are OK
	LED red on: Module reports an error
	LED red blinks with 1Hz: Error in configuration
	LEDs green are blinking with 1Hz: Error backplane bus communication

M32-1BD70 - AO 4 x 12Bit U

LEDs connectors

Pin	Function	LED	Description
X2:5	L+	green	DC 24V electronic section supply OK
X1:5	AO 0	red	Error channel x ■ Error in parameterization ■ Wire break (if parameterized)
X1:2	AO 1	red	
X3:1	AO 2	red	
X3:4	AO 3	red	

Pin assignment

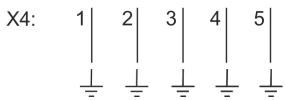
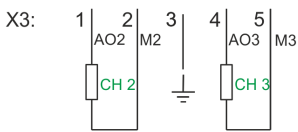
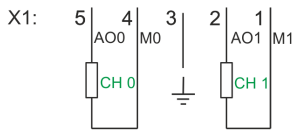
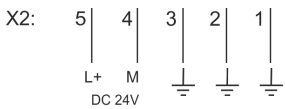

	Pin	Function	Type	LED	Description
X2:	1		O		Shield
	2		O		Shield
	3		I		Shield
	4	M	I		Ground power supply (M)
	5	L+	I	green	Power supply DC 24V (L+)
X1:	1	M1	O		Ground CH 1
	2	AO1	O	red	Analog Output CH 1
	3		O		Shield
	4	M0	O		Ground CH 0
	5	AO0	O	red	Analog Output CH 0
X3:	1	AO2	O	red	Analog Output CH 2
	2	M2	O		Ground CH 2
	3		O		Shield
	4	AO3	O	red	Analog Output CH 3
	5	M3	O		Ground CH 3
X4:	1		O		Shield
	2		O		Shield
	3		O		Shield
	4		O		Shield
	5		O		Shield

I: Input | O: Output

Input area

No byte of the input area is used by the module.

Output area

Addr.	Name	Byte	Function
+0	PIQ	0	Status of the outputs <ul style="list-style-type: none"> ■ Bit 0: Channel CH 0 ■ Bit 1: Channel CH 1 ■ Bit 2: Channel CH 2 ■ Bit 3: Channel CH 3

4.5.1 Parameter data

DS - Record set for access via CPU, PROFIBUS and PROFINET

Name	Bytes	Function	Default	DS
RES0	1	reserved	00h	00h
SHORT_EN	1	Short-circuit recognition	00h	00h
CH0FN	1	Function number channel 0	12h	80h
CH1FN	1	Function number channel 1	12h	81h
CH2FN	1	Function number channel 2	12h	82h
CH3FN	1	Function number channel 3	12h	83h

SHORT_EN Short-circuit recognition

Byte	Bit 7 ... 0
0	<ul style="list-style-type: none"> ■ Bit 0: Short-circuit recognition channel 0 (1: on) ■ Bit 1: Short-circuit recognition channel 1 (1: on) ■ Bit 2: Short-circuit recognition channel 2 (1: on) ■ Bit 3: Short-circuit recognition channel 3 (1: on) ■ Bit 7 ... 4: reserved

CHxFN Function number channel x

In the following there are the measuring ranges with corresponding function number listed, which were supported by the analog module. With FFh the corresponding channel is deactivated. The formulas listed here allow you to transform an evaluated measuring value (digital value) to a value assigned to the measuring range (analog value) and vice versa.

±10V

Output range (funct. no.)	Voltage (U)	Decimal (D)	Hex	Range	Formulas
±10V Siemens S format (12h)	11.76V	32511	7EFFh	overrange	$U = D \times \frac{10}{27648}$ $D = 27648 \times \frac{U}{10}$
	10V	27648	6C00h	nominal range	
	5V	13824	3600h		
	0V	0	0000h		
	-5V	-13824	CA00h		
	-10V	-27648	9400h	underrange	
	-11.76V	-32512	8100h		
±10V Siemens S5 format (22h)	12.5V	20480	5000h	overrange	$U = D \times \frac{10}{16384}$ $D = 16384 \times \frac{U}{10}$
	10V	16384	4000h	nominal range	
	5V	8192	2000h		
	0V	0	0000h		
	-5V	-8192	E000h		
	-10V	-16384	C000h		
	-12.5V	-20480	B000h	underrange	

0 ... 10V

Output range (funct. no.)	Voltage (U)	Decimal (D)	Hex	Range	Formulas
0 ... 10V Siemens S7 format (10h)	11.76V	32511	7EFFh	overrange	$U = D \times \frac{10}{27648}$ $D = 27648 \times \frac{U}{10}$
	10V	27648	6C00h	nominal range	
	5V	13824	3600h		
	0V	0	0000h		
	Not possible, is limited to 0V.				
0 ... 10V Siemens S5 format (20h)	12.5V	20480	5000h	overrange	$U = D \times \frac{10}{16384}$ $D = 16384 \times \frac{U}{10}$
	10V	16384	4000h	nominal range	
	5V	8192	2000h		
	0V	0	0000h		
	Not possible, is limited to 0V.				

4.5.2 Diagnostic data

So this module does not support interrupt functions, the diagnostics data serves information about this module. On error the corresponding channel LED of the module is activated and the error is registered in the diagnostics data.

The following errors are listed in the diagnostics data:

- Error in project engineering / parameterization
- Short-circuit/overload (if parameterized)

DS - Record set for access via CPU, PROFIBUS and PROFINET. The access happens by DS 01h. Additionally the first 4 bytes may be accessed by DS 00h.

Name	Bytes	Function	Default	DS
ERR_A	1	Diagnostic	00h	01h
MODTYP	1	Module information	15h	
ERR_C	1	reserved	00h	
ERR_D	1	Diagnostic	00h	
CHTYP	1	Channel type	73h	
NUMBIT	1	Number diagnostic bits per channel	08h	
NUMCH	1	Number of channels of a module	04h	
CHERR	1	Channel error	00h	
CH0ERR	1	Channel-specific error channel 0	00h	
CH1ERR	1	Channel-specific error channel 1	00h	
CH2ERR	1	Channel-specific error channel 2	00h	
CH3ERR	1	Channel-specific error channel 3	00h	
CH4ERR... CH7ERR	4	reserved	00h	
DIAG_US	4	µs ticker	00h	

ERR_A Diagnostic

Byte	Bit 7 ... 0
0	<ul style="list-style-type: none"> ■ Bit 0: set at module failure ■ Bit 1: set at internal error ■ Bit 2: set at external error ■ Bit 3: set at channel error ■ Bit 4: set at external auxiliary supply missing ■ Bit 6 ... 5: reserved ■ Bit 7: set at error in parameterization

M32-1BD70 - AO 4 x 12Bit U > Diagnostic data

MODTYP Module information

Byte	Bit 7 ... 0
0	<ul style="list-style-type: none"> ■ Bit 3 ... 0: module class <ul style="list-style-type: none"> – 0101b: Analog module ■ Bit 4: Channel information available ■ Bit 7 ... 5: reserved

ERR_D Diagnostic

Byte	Bit 7 ... 0
0	<ul style="list-style-type: none"> ■ Bit 2 ... 0: reserved ■ Bit 3: set at internal diagnostics buffer overflow ■ Bit 4: set at internal communication error ■ Bit 7 ... 5: reserved

CHTYP Channel type

Byte	Bit 7 ... 0
0	<ul style="list-style-type: none"> ■ Bit 6 ... 0: Channel type <ul style="list-style-type: none"> – 73h: Analog output ■ Bit 7: reserved

NUMBIT Diagnostic bits

Byte	Bit 7 ... 0
0	Number of diagnostic bits per channel (here 08h)

NUMCH Channels

Byte	Bit 7 ... 0
0	Number of channels of the module (here 04h)

CHERR Channel error

Byte	Bit 7 ... 0
0	<ul style="list-style-type: none"> ■ Bit 0: set at error in channel group 0 ■ Bit 1: set at error in channel group 1 ■ Bit 2: set at error in channel group 2 ■ Bit 3: set at error in channel group 3 ■ Bit 7 ... 4: reserved

CH0ERR ... CH3ERR Channel-specific

Byte	Bit 7 ... 0
0	Channel-specific error channel x: <ul style="list-style-type: none"> ■ Bit 0: set at configuring/parameter assignment error ■ Bit 2 ... 1: reserved ■ Bit 3: set at short-circuit to ground ■ Bit 7 ... 4: reserved

DIAG_US μ s ticker

Byte	Bit 7 ... 0
0...3	Value of the μ s ticker at the moment of the diagnostic <ul style="list-style-type: none">■ In the System MICRO module there is a timer (μs ticker). With PowerON the timer starts counting with 0. After $2^{32}-1\mu$s the timer starts with 0 again.

4.5.3 Technical data

Order no.	M32-1BD70
Type	SM M32 - Analog output
Module ID	050A 25E0
Current consumption/power loss	
Current consumption from backplane bus	60 mA
Power loss	0.9 W
Technical data analog outputs	
Number of outputs	4
Cable length, shielded	200 mm
Rated load voltage	DC 24 V
Reverse polarity protection of rated load voltage	✓
Current consumption from load voltage L+ (without load)	-
Voltage output short-circuit protection	✓
Voltage outputs	✓
Min. load resistance (voltage range)	5 kΩ
Max. capacitive load (current range)	1 μF
Max. inductive load (current range)	10 mA
Output voltage ranges	-10 V ... +10 V 0 V ... +10 V
Operational limit of voltage ranges	+/-0.3%
Basic error limit voltage ranges	+/-0.2%
Destruction limit against external applied voltage	max. 24V
Current outputs	-
Max. in load resistance (current range)	-
Max. inductive load (current range)	-
Typ. open circuit voltage current output	-
Output current ranges	-
Operational limit of current ranges	-
Basic error limit current ranges	-
Destruction limit against external applied voltage	-
Settling time for ohmic load	2 ms
Settling time for capacitive load	4 ms
Settling time for inductive load	-
Resolution in bit	12
Conversion time	2 ms all channels
Substitute value can be applied	no

Order no.	M32-1BD70
Output data size	8 Byte
Status information, alarms, diagnostics	
Status display	yes
Interrupts	no
Process alarm	no
Diagnostic interrupt	no
Diagnostic functions	yes
Diagnostics information read-out	possible
Supply voltage display	green LED
Group error display	Bicolour green/red LED
Channel error display	red LED per channel
Isolation	
Between channels	-
Between channels of groups to	-
Between channels and backplane bus	✓
Between channels and power supply	✓
Max. potential difference between circuits	-
Max. potential difference between inputs (Ucm)	-
Max. potential difference between Mana and Mintern (Uiso)	DC 75 V/ AC 50 V
Max. potential difference between inputs and Mana (Ucm)	-
Max. potential difference between inputs and Mintern (Uiso)	-
Max. potential difference between Mintern and outputs	-
Insulation tested with	DC 500 V
Datasizes	
Input bytes	0
Output bytes	8
Parameter bytes	10
Diagnostic bytes	20
Housing	
Material	PPE / PPE GF10
Mounting	Profile rail 35 mm
Mechanical data	
Dimensions (WxHxD)	26 mm x 88 mm x 71 mm
Net weight	94 g
Weight including accessories	94 g

M32-1BD70 - AO 4 x 12Bit U > Technical data

Order no.	M32-1BD70
Gross weight	107 g
Environmental conditions	
Operating temperature	0 °C to 60 °C
Storage temperature	-25 °C to 70 °C
Certifications	
UL certification	in preparation
KC certification	in preparation