



Main Catalog 2014/2015

for specialists in automation and control technology

Welcome to VIPA



This is VIPA

- Specialists in automation and control systems.
- Developer in some to the most advanced products in the PLC field.
- Developer of some of the world's fastest hard PLCs of their class.
- Developer of technologies that are now the industry standard.
- Global Player with branches in 60 countries.
- Extremely customer oriented and flexible.



VIPA has traditionally been amongst the most innovative suppliers of memory-programmable controllers (PLCs) in the market and is growing worldwide, with double-digit growth rates. Therefore, VIPA belongs to the still young, but also exceptionally successful companies in the Automation market.

Our success is based on five pillars:

- High rate of innovation and quick decision making
- Various unique features
- A convincing cost-performance ratio
- Commitment and competence of our employees
- Cooperation with powerful partners

Our aspiration:

- Constantly continue to improve existing technologies, but also to introduce new and innovative trends in the market.
- Continuous flexible adaptation of our products to current market needs and to further increase our market acceptance.
- Continue to develop our personnel resources in sales, development, quality assurance and service in accordance with our revenue growth.
- Enter into cooperation agreements with powerful partners and to increase our market share through joint market cultivation.

To meet this aspiration, we consider it as our aim, also in the future, to improve what is established, to question, revise or develop completely from new.

Furthermore we want to make available to our partners and customers also in the future through continuous innovation and smart system maintenance unique technological features with which together we can gain new and satisfied system users.

With our highly motivated employees, we're working hard on improving our quality, service and the satisfaction of our customers and partners. Convince yourself of the possibilities that our automation solutions and systems offer, and discover how with us you can sustainably increase your competitiveness.

Strengthened by above-average growth, we are determined to continue our successful path in the future.

We look forward to cooperating with you!

Management

Wolfgang Seel | Bob Linkenbach | Manfred Stern

We speak your language ...



SPEED7 ensures your lead

- a flexible automation platform
- and one of the fastest STEP7 PLC processors in the world!

SPEED7 technology offers developers a modular building block, with which a high-performance automation system can be developed in the shortest time on an open STEP7 architecture.

- SPEED7 ensures maximum speed with all applications and, for example, the highest clock rates.
- SPEED7 upgrades also older systems to a modern standard.
- SPEED7 processes vast amounts of data in real time.





... and in future also that of almost all systems

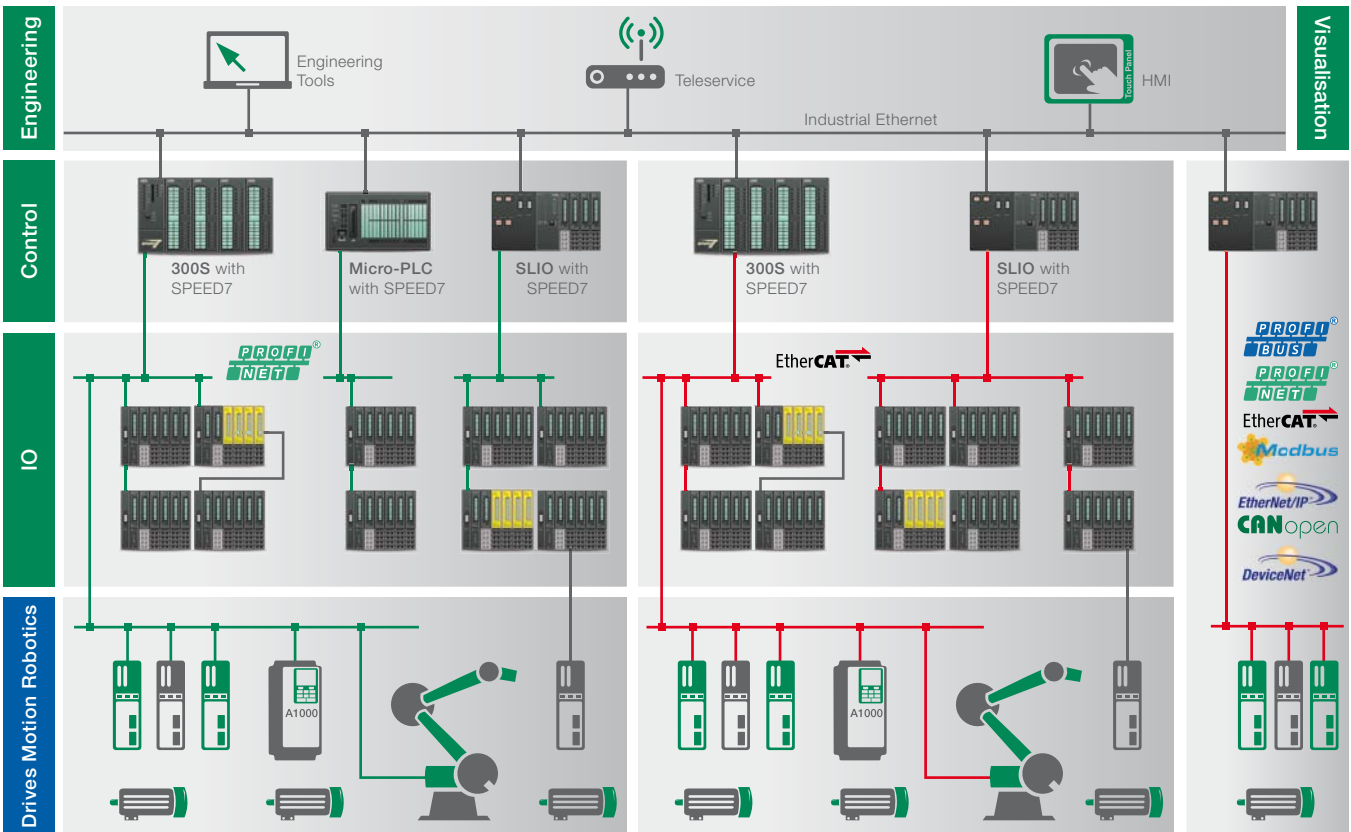

System solutions



Professional benefits for professional applications

- **Consistent standardization**
All systems are programmable with VIPA WinPLC7 programming tool and/or with STEP7 from Siemens and in the future with the new engineering framework SPEED7 Studio.
- **Increase of productivity**
Significant reduction in cycle times of user programs by SPEED7 technology with reduced power dissipation.
- **High efficiency**
Above average basic features of the systems, integrated RJ45 Ethernet interface for PG/OP communication, optional integrated SPEED-Bus.
- **Absolute flexibility**
Mixed operation for example with VIPA CPUs and Siemens assemblies possible.
- **Open communication possibilities**
Supports internationally established communication standards like Ethernet, PROFIBUS, CANopen, EtherCAT, Modbus, EtherNet/IP, DeviceNet, Interbus, PROFINET and ASI.

Automotive:

An industry that needs solutions like on an assembly line. Ever increasing range of models, more and more complex technology, ever faster product cycles. Whoever wants to survive here, must be able to refine, expand, and accelerate his technology.

**Renewable energy:**

In principle every installation of a VIPA control system has its own energy policy - on starting up the efficiency increases right away, often the consumption of raw materials sinks and his conscience is eased.

**Building automation:**

Low energy is the goal, high performance is our way... Here our control systems are more intelligent than some specifications.

**Food & Beverage:**

Multi-purpose demands: Flash-freezing and autoclaving, vacuum packing and pressurized filling go on here. The whole thing under the toughest hygiene conditions and always under time pressure.

**Handling and storage technology:**

In order that the delivery rate never stands still, not only are tailor-made PLC systems designed at VIPA, but also precise, effective time schedules for their installation.

**Environment:**

Regardless of whether it's a question of renewable energy or water/sewage: The very strict requirements in terms of robustness, compact design and of energy consumption of the controllers can be excellently implemented with our automation technology.

**Packaging:**

The most important factor in this industry: Speed. Because many commodities are perishable, deliveries must arrive just in time and demand simply fluctuates.

**Water/Sewage:**

That a manufacturer of control engineering knows how a sewage plant works seems unusual. But this is typical VIPA. At VIPA no one turns his nose up when it comes to dealing with anaerobic digestion tanks, activated sludge and denitrification.



„From a producer of components to a supplier of systems“

worldwide
first Inrack-PC

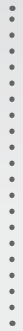

200V Modular control system
for central and decentral
applications



300S One of the fastest
control systems programmable
with STEP7



500S PC control system for complex tasks.
And also one of the fastest control systems
programmable with STEP7

1985

VIPA



Foundation of **VIPA GmbH**
by Wolfgang Seel

Foundation of
profichip GmbH

Move to the **new headquarter**
of VIPA and profichip in
Herzogenaurach

Winner of the innovation prize
„**Initiative Mittelstand 2007**“
for the SPEED7 technology

Operating / monitoring devices

From two-line displays
to touch panels

Accessories

enhancing, linking,
optimizing

SLIO One of the most efficient
and most modern decentral I/O
systems in the world

Software for convenient
programming and
parameterization



2014



Winner of the industry prize
„Industrie Preis 2008“ for
the SPEED7 technology













Honoured as top
innovator by Top100

awarded with the **Jobstar** of
Metropolitan Region Nuremberg

YASKAWA

Majority shareholding of
YASKAWA Europe GmbH
at the VIPA GmbH



<p>SLIO: The System SLIO is a highly compact control system for decentralized applications.</p>	<p>12</p>	
<p>100V: The System 100V is a Micro-PLC system from VIPA.</p>	<p>140</p>	
<p>200V: The System 200V is a highly compact and modular control system for centralized and decentralized applications.</p>	<p>242</p>	
<p>300S: With the SPEED7 technology, System 300S is one of the fastest control system in the world programmable with STEP7.</p>	<p>410</p>	
<p>500S: With the SPEED7 technology, System 500S is one of the fastest control system in the world programmable with STEP7 specifically for usage in PC's.</p>	<p>552</p>	
<p>HMI: Our Touch Panels with display sizes of 4,3" to 15" and our Panel PCs with sizes of 15,6" and 21" provide universally desirable solutions.</p>	<p>568</p>	
<p>Teleservice: The VIPA Teleservice modules are suitable for very easy and safe remote access to your plant with state of the art VPN technology in combination with high performance hardware.</p>	<p>638</p>	
<p>Starter Kits: Complete product sets for the immediate and cost saving access into the most important VIPA product groups packed in a robust transport case.</p>	<p>646</p>	
<p>Safety: Samos PRO is a compact and modular constructed safety micro controller for fast monitoring and control of your applications in machinery and plant construction.</p>	<p>652</p>	
<p>Solutions: VIPA Green Solution offers an energy management system, with which a certification in accordance with DIN EN ISO 50001 for the use of energy saving potentials in your business is implemented in the simplest way.</p>	<p>664</p>	
<p>Software: For comfortable programming und parameterization.</p>	<p>670</p>	
<p>Accessories: VIPA offers a wide range of accessories like programming cable, download cable, or PROFIBUS cable as well as PROFIBUS connectors with diagnosis function.</p>	<p>680</p>	
<p>Appendix: List of our worldwide distributors and branch offices as well as terms and conditions of sale and delivery.</p>	<p>688</p>	

At a glance

System description SLIO	14
Clamp modules	16
CPUs	20
Power modules	36
Signal modules digital	42
Signal modules analog	74
Communication processors	108
Function modules	114
Interface modules	128
SLIO accessories	136



| SLIO

System description SLIO

Structure and Concept

SLIO stands for Slice I/O. The system is very compact and can be adapted piecemeal exactly to the requirements of the application.

The system is designed for decentralized automation tasks.

With the help of the power module (PM), color contrasted from the signal modules (SM) and functional modules (FM), these are supplied with power and separate potential groups can be defined as required. The terminal module (TM) combines clamp, seating for the electronic module (EM) and mechanical bus connector. The electronic modules are connected to the terminal module in a secure sliding mechanism. In the case of service, only the electronic module is replaced by simply pulling out of the terminal module – wiring and mounting remain on the 35 mm profile rail. The step-formed spring-type terminals on the terminal module enable a quick, clear and secure wiring. Through integrated status LEDs and the label strip on the front a channel-specific, unambiguous allocation, and readability of the channel conditions of the electronic module is ensured.

All interface modules (IM) for PROFIBUS-DP, CANopen, PROFINET, EtherCAT, DeviceNet, Ethernet/IP and Modbus/TCP support up to 64 electronic modules.

The space-saving assembly size allows use in any automation environment.

Assembly is very easy: First the terminal modules are connected, then the electronic modules are inserted into the slot designated for the terminal module until the connection between both module parts is established by an audible click.

SLIO is one of the most highly efficient decentral systems worldwide and is evolving daily.



Performance and Application

SLIO is designed for large decentralized automation tasks in the manufacturing and process industries. SLIO expands key solutions and is integrated with the help of the device master files into existing fieldbus infrastructure. Through the new backplane bus concept the interface modules (fieldbus slave) in SLIO enable very short response times for signal processing.

Functions

A variety of signal modules are available for the connection of sensors and actuators for acquiring digital and analog signals to and from the process.

For positioning, path measurement, counting tasks and other functions further functional modules are continuously being developed.

Communication

SLIO includes interface modules (fieldbus slave modules) with different fieldbus protocols by which the system, manufacturer-independent, can be integrated into most automation concepts.

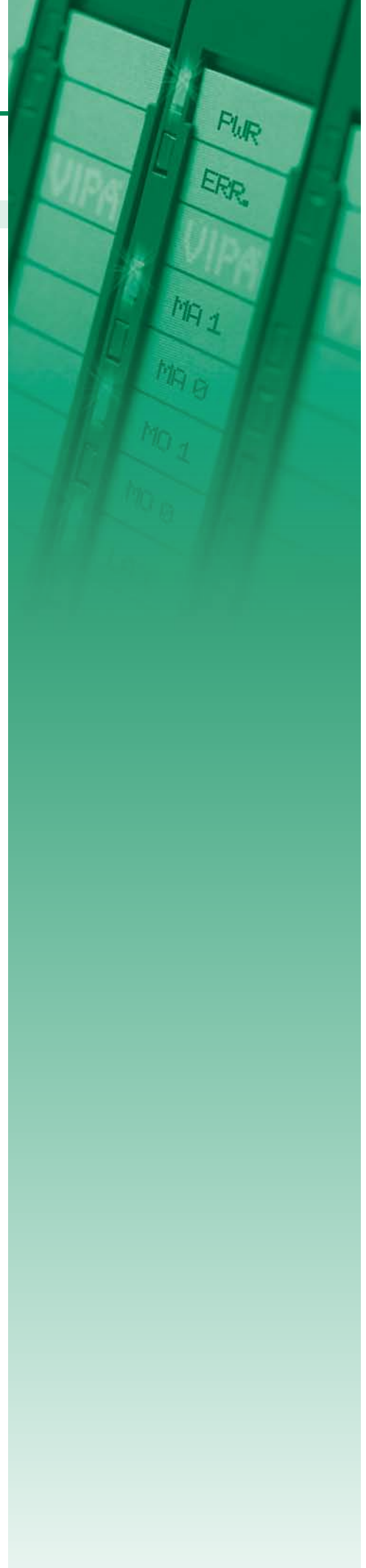

Clamp modules



Assembly and function

Clamp modules are passive modules for 2- or 3-wire installations, whose contacts are vertical electrical connected internal. Within the module the backplane bus feed-through. The module does not have any module identification, but is considered at the maximum number of the modules.

Through the application of the clamp modules, distributors for power supply could be realized easily and enables so the connection of active supplied sensors like proximity switch. The wiring is done via timesaving and secure cage clamp technique.

The clamp modules are fixed on the mounting surface by means of a 35mm DIN rail.

Features

- › Maintenance-free cage clamp technique
- › Backplane bus feed-through
- › Max. terminal voltage 10A
- › Potential separation 500 Veff (field voltage to bus)
- › Mounting on a 35mm DIN rail
- › 24 month guarantee



Overview

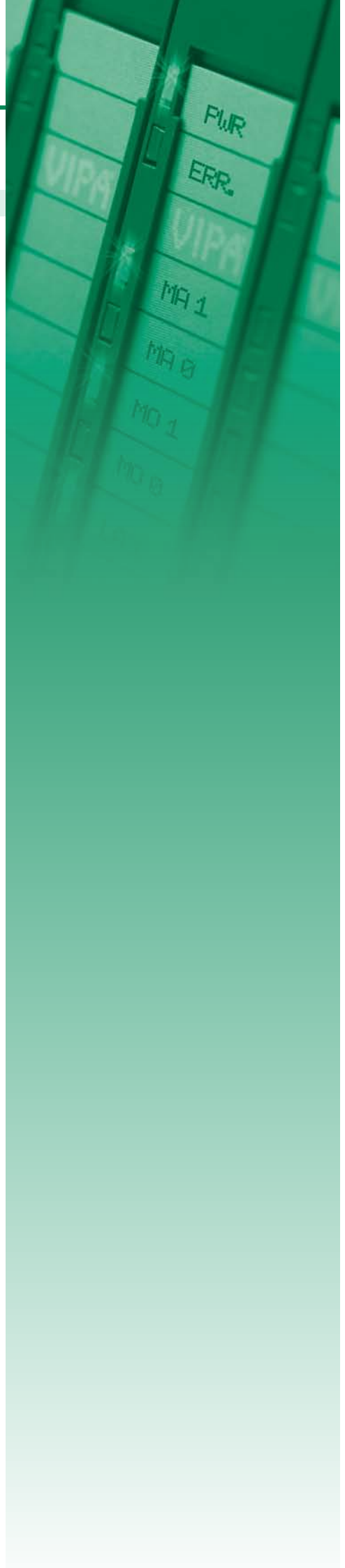

Order no.	Name/Description	Page
Clamp modules		
001-1BA00	CM 001 - Potential distributor module ‣ 8xDC 24 V clamps	18
001-1BA10	CM 001 - Potential distributor module ‣ 8xDC 0 V clamps	18
001-1BA20	CM 001 - Potential distributor module ‣ 4xDC 24 V, 4xDC 0 V clamps	18



Clamp modules

Clamp modules | Clamp modules

001-1BA00
001-1BA10
001-1BA20

Order number	001-1BA00	001-1BA10	001-1BA20	
Figure				
Type	CM 001	CM 001	CM 001	
Module ID	-	-	-	
General information				
Note	-	-	-	
Features	▶ 8xDC 24 V clamps	▶ 8xDC 0 V clamps	▶ 4xDC 24 V, 4xDC 0 V clamps	
Clamp parameter				
Terminal voltage max.	DC 30 V	DC 0 V	DC 30 V	
Terminal current max.	10 A	10 A	10 A	
Total current per module, max.	10 A	10 A	10 A	
Isolated group				
Number of clamps	2*4	2*4	4-4	
Color of clamps	grey	grey	grey-grey	
Binding of potential	Field voltage DC 24V	Field voltage DC 0V	Field voltage DC 24V- Field voltage DC 0V	
Potential group current, max.	10 A	10 A	10 A-10 A	
Housing				
Material	PPE / PPE GF10	PPE / PPE GF10	PPE / PPE GF10	
Mounting	Profile rail 35 mm	Profile rail 35 mm	Profile rail 35 mm	
Mechanical data				
Dimensions (WxHxD)	12.9 mm x 109 mm x 52.5 mm	12.9 mm x 109 mm x 52.5 mm	12.9 mm x 109 mm x 52.5 mm	
Weight	50 g	50 g	50 g	
Environmental conditions				
Operating temperature	0 °C to 60 °C	0 °C to 60 °C	0 °C to 60 °C	
Storage temperature	-25 °C to 70 °C	-25 °C to 70 °C	-25 °C to 70 °C	
Certifications				
UL508 certification	yes	yes	yes	

Connections, Interfaces

Clamp modules | Clamp modules

001-1BA00
001-1BA10
001-1BA20

001-1BA00

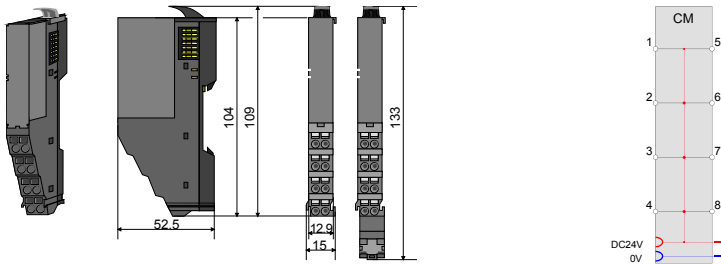

001-1BA10

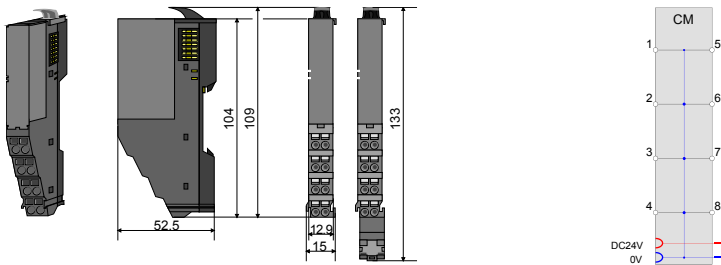

001-1BA20

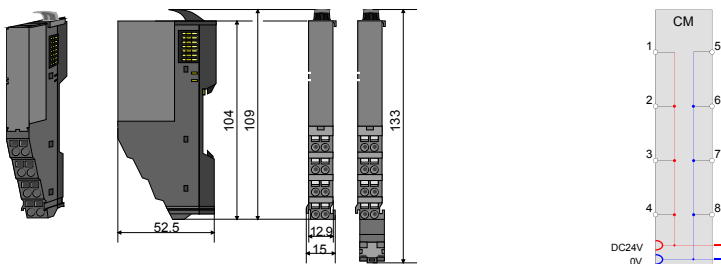

CPUs



SLIO-CPU

Features known from the SPEED7 CPUs 300S Series have been integrated into the SLIO CPUs. Thus, memory management with flexible memory adaptation via the Memory Configuration Card (MCC), known from the SPEED7 CPUs of the 300 series, is present again in the SLIO CPUs, but has been updated. The VSC (VIPASetCard) now allows for two hardware variants to generate a total of 24 CPU variants. Even in its basic configuration, without the optional VSC, both hardware variants already provide so much memory, that many of the common applications can run immediately. With the help of the VSC, the memory can be expanded and the PROFIBUS communication can be enabled in both basic CPUs. Only the SD card has to be plugged into the CPU of the selected hardware variant. Then the additional features can be used immediately with the first operation. The VSC can also be used like any other standard SD card for storage of program and data. Programming is realized in the SIMATIC world, familiar to most users, i.e. concretely with STEP 7 or TIA Portal from Siemens.

Features of the SLIO CPU

- Integrated new SPEED7 7100DEV processor for outstanding performance
- Extremely fast backplane bus with 48Mbit/s
- Flexible memory expansion and extension of the communication possibilities without CPU-swap.
- Optional PROFIBUS Master or Slave which can be activated via VSC
- Second Ethernet interface with PROFINET-Controller integrated with the basic CPU 015
- Usable centralized and decentralized up to 64 modules – directly to the CPU
- Only two types of hardware for comprehensive savings in warehousing and logistic costs



Overview

Order no.	Name/Description	Page
CPUs STEP7 programmable, standard		
014-CEF0R00	CPU 014 - SPEED7 technology <ul style="list-style-type: none"> › SPEED7 technology › 64 kB work memory › Memory extension (max. 192 kB) via VIPASetCard › PROFIBUS slave/master activatable via VIPASetCard › Full-switchable serial interface integrated 	22
CPUs STEP7 programmable, PROFINET		
015-CEFPR00	CPU 015 - SPEED7 technology <ul style="list-style-type: none"> › SPEED7 technology › 256 kB work memory › Memory extension (max. 512 kB) via VIPASetCard › PROFIBUS slave/master activatable via VIPASetCard › Full-switchable serial interface integrated › PROFINET controller for up to 128 participants integrated 	28

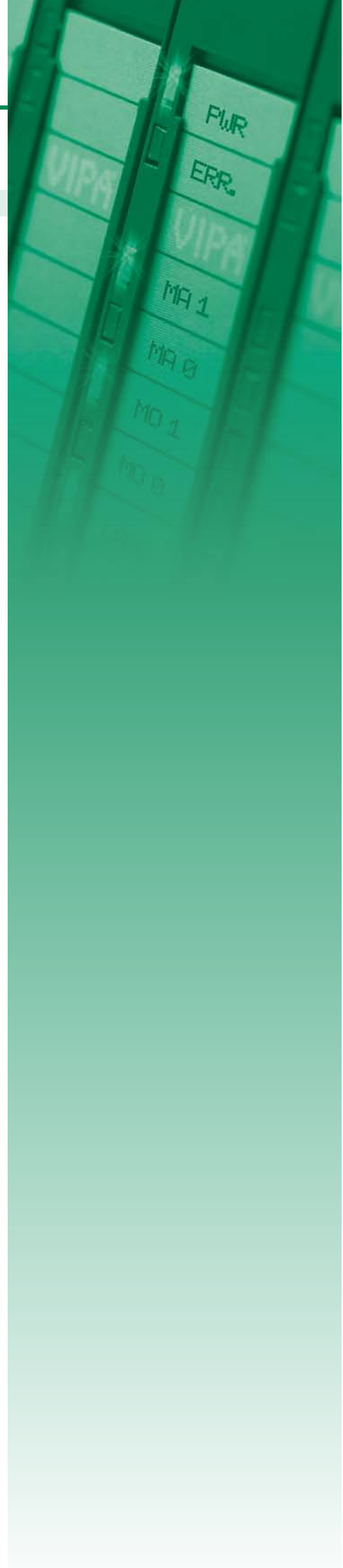

CPUs STEP7 programmable, standard

CPUs | CPUs STEP7 programmable, standard

014-CEF0R00					
-------------	--	--	--	--	--

Order number	014-CEF0R00			
Figure				
Type	CPU 014			
General information				
Note	-			
Features	<ul style="list-style-type: none"> ▶ SPEED7 technology ▶ 64 kB work memory ▶ Memory extension (max. 192 kB) via VIPASetCard ▶ PROFIBUS slave/master activatable via VIPASetCard ▶ Full-switchable serial interface integrated 			
SPEED-Bus	-			
Technical data power supply				
Power supply (rated value)	DC 24 V			
Power supply (permitted range)	DC 20.4...28.8 V			
Reverse polarity protection	✓			
Current consumption (no-load operation)	120 mA			
Current consumption (rated value)	1 A			
Inrush current	3 A			
I^2t	0.1 A ² s			
Max. current drain at backplane bus	3 A			
Power loss	6 W			
Load and working memory				
Load memory, integrated	192 KB			
Load memory, maximum	192 KB			
Work memory, integrated	64 KB			
Work memory, maximal	192 KB			
Memory divided in 50% program / 50% data	✓			
Memory card slot	SD/MMC-Card with max. 2 GB			
Hardware configuration				
Racks, max.	1			
Modules per rack, max.	64			
Number of integrated DP master	1			
Number of DP master via CP	-			
Operable function modules	64			
Operable communication modules PtP	64			
Operable communication modules LAN	-			

CPUs CPUs STEP7 programmable, standard						
014-CEFOR00						

Order number	014-CEFOR00			
Command processing times				
Bit instructions, min.	0.02 µs			
Word instruction, min.	0.02 µs			
Double integer arithmetic, min.	0.02 µs			
Floating-point arithmetic, min.	0.12 µs			
Timers/Counters and their retentive characteristics				
Number of S7 counters	512			
S7 counter remanence	adjustable 0 up to 512			
S7 counter remanence adjustable	C0 .. C7			
Number of S7 times	512			
S7 times remanence	adjustable 0 up to 512			
S7 times remanence adjustable	not retentive			
Data range and retentive characteristic				
Number of flags	8192 Byte			
Bit memories retentive characteristic adjustable	adjustable 0 up to 8192			
Bit memories retentive characteristic preset	MB0 .. MB15			
Number of data blocks	1024			
Max. data blocks size	64 KB			
Number range DBs	1 ... 8191			
Max. local data size per execution level	4096 Byte			
Max. local data size per block	4096 Byte			
Blocks				
Number of OBs	24			
Maximum OB size	64 KB			
Totalnumber DBs, FBs, FCs	1024			
Number of FBs	1024			
Maximum FB size	64 KB			
Number range FBs	0 ... 8191			
Number of FCs	1024			
Maximum FC size	64 KB			
Number range FC2	0 ... 8191			
Maximum nesting depth per priority class	16			
Maximum nesting depth additional within an error OB	4			
Time				
Real-time clock buffered	✓			
Clock buffered period (min.)	30 d			
Type of buffering	-			
Load time for 50% buffering period	15 min			
Load time for 100% buffering period	1 h			
Accuracy (max. deviation per day)	10 s			
Number of operating hours counter	8			
Clock synchronization	✓			
Synchronization via MPI	Master/Slave			
Synchronization via Ethernet (NTP)	no			

CPUs | CPUs STEP7 programmable, standard

014-CEF0R00						
-------------	--	--	--	--	--	--

Order number	014-CEF0R00			
Address areas (I/O)				
Input I/O address area	2048 Byte			
Output I/O address area	2048 Byte			
Process image adjustable	✓			
Input process image preset	128 Byte			
Output process image preset	128 Byte			
Input process image maximal	2048 Byte			
Output process image maximal	2048 Byte			
Digital inputs	16384			
Digital outputs	16384			
Digital inputs central	512			
Digital outputs central	512			
Integrated digital inputs	-			
Integrated digital outputs	-			
Analog inputs	1024			
Analog outputs	1024			
Analog inputs, central	256			
Analog outputs, central	256			
Integrated analog inputs	-			
Integrated analog outputs	-			
Communication functions				
PG/OP channel	✓			
Global data communication	✓			
Number of GD circuits, max.	8			
Size of GD packets, max.	22 Byte			
S7 basic communication	✓			
S7 basic communication, user data per job	76 Byte			
S7 communication	✓			
S7 communication as server	✓			
S7 communication as client	-			
S7 communication, user data per job	160 Byte			
Number of connections, max.	32			
Functionality Sub-D interfaces				
Type	X2			
Type of interface	RS485			
Connector	Sub-D, 9-pin, female			
Electrically isolated	✓			
MPI	✓			
MP ² (MPI/RS232)	-			
DP master	-			
DP slave	-			
Point-to-point interface	✓			

CPUs CPUs STEP7 programmable, standard						
014-CEF0R00						

Order number	014-CEF0R00			
Type	X3			
Type of interface	RS485			
Connector	Sub-D, 9-pin, female			
Electrically isolated	✓			
MPI	✓			
MP ² I (MPI/RS232)	-			
DP master	optional			
DP slave	optional			
Point-to-point interface	-			
Functionality MPI				
Number of connections, max.	32			
PG/OP channel	✓			
Routing	✓			
Global data communication	✓			
S7 basic communication	✓			
S7 communication	✓			
S7 communication as server	✓			
S7 communication as client	-			
Transmission speed, min.	19.2 kbit/s			
Transmission speed, max.	12 Mbit/s			
Functionality PROFIBUS master				
PG/OP channel	✓			
Routing	✓			
S7 basic communication	✓			
S7 communication	✓			
S7 communication as server	✓			
S7 communication as client	-			
Activation/deactivation of DP slaves	-			
Direct data exchange (slave-to-slave communication)	-			
DPV1	✓			
Transmission speed, min.	9.6 kbit/s			
Transmission speed, max.	12 Mbit/s			
Number of DP slaves, max.	124			
Address range inputs, max.	2 KB			
Address range outputs, max.	2 KB			
User data inputs per slave, max.	244 Byte			
User data outputs per slave, max.	244 Byte			
Functionality PROFIBUS slave				
PG/OP channel	✓			
Routing	✓			
S7 communication	✓			
S7 communication as server	✓			
S7 communication as client	-			
Direct data exchange (slave-to-slave communication)	-			
DPV1	✓			

CPUs | CPUs STEP7 programmable, standard

014-CEF0R00

Order number	014-CEF0R00			
Transmission speed, min.	9.6 kbit/s			
Transmission speed, max.	12 Mbit/s			
Automatic detection of transmission speed	-			
Transfer memory inputs, max.	244 Byte			
Transfer memory outputs, max.	244 Byte			
Address areas, max.	32			
User data per address area, max.	32 Byte			
Point-to-point communication				
PtP communication	✓			
Interface isolated	✓			
RS232 interface	-			
RS422 interface	-			
RS485 interface	✓			
Connector	Sub-D, 9-pin, female			
Transmission speed, min.	150 bit/s			
Transmission speed, max.	115.5 kbit/s			
Cable length, max.	500 m			
Point-to-point protocol				
ASCII protocol	✓			
STX/ETX protocol	✓			
3964(R) protocol	✓			
RK512 protocol	-			
USS master protocol	✓			
Modbus master protocol	✓			
Modbus slave protocol	✓			
Special protocols	-			
Functionality RJ45 interfaces				
Type	X1			
Type of interface	Ethernet 10/100 MBit			
Connector	RJ45			
Electrically isolated	✓			
PG/OP channel	✓			
Number of connections, max.	4			
Productive connections	-			
Housing				
Material	PPE			
Mounting	Profile rail 35 mm			
Mechanical data				
Dimensions (WxHxD)	131.5 mm x 109 mm x 83 mm			
Weight	280 g			
Environmental conditions				
Operating temperature	0 °C to 60 °C			
Storage temperature	-25 °C to 70 °C			
Certifications				
UL508 certification	in preparation			

Connections, Interfaces

CPUs | CPUs STEP7 programmable, standard

014-CEF0R00					
-------------	--	--	--	--	--

014-CEF0R00

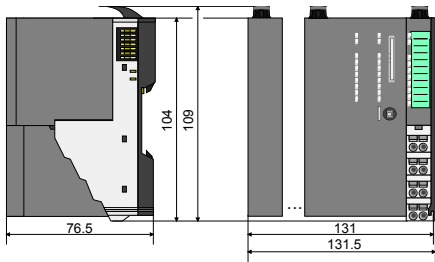

- ① Transmit +
- ② Transmit -
- ③ Receive +
- ④ -
- ⑤ -
- ⑥ Receive -
- ⑦ -
- ⑧ -

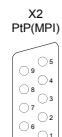

- ① n.c.
- ② M24V
- ③ RxD/TxD-P (line B)
- ④ RTS
- ⑤ M5V
- ⑥ P5V
- ⑦ P24V
- ⑧ RxD/TxD-N (line A)
- ⑨ n.c.

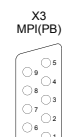

- ① n.c.
- ② M24V
- ③ RxD/TxD-P (line B)
- ④ RTS
- ⑤ M5V
- ⑥ P5V
- ⑦ P24V
- ⑧ RxD/TxD-N (line A)
- ⑨ n.c.

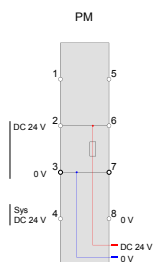

CPUs STEP7 programmable, PROFINET

CPUs | CPUs STEP7 programmable, PROFINET

015-CEFPR00					
-------------	--	--	--	--	--

Order number	015-CEFPR00			
Figure				
Type	SLIO CPU 015			
General information				
Note	-			
Features	<ul style="list-style-type: none"> ▸ SPEED7 technology ▸ 256 kB work memory ▸ Memory extension (max. 512 kB) via VIPASetCard ▸ PROFIBUS slave/master activatable via VIPASetCard ▸ Full-switchable serial interface integrated ▸ PROFINET controller for up to 128 participants integrated 			
SPEED-Bus	-			
Technical data power supply				
Power supply (rated value)	DC 24 V			
Power supply (permitted range)	DC 20.4...28.8 V			
Reverse polarity protection	✓			
Current consumption (no-load operation)	150 mA			
Current consumption (rated value)	1.1 A			
Inrush current	3 A			
I _t ²	0.1 A ² s			
Max. current drain at backplane bus	3 A			
Power loss	7.5 W			
Load and working memory				
Load memory, integrated	512 KB			
Load memory, maximum	512 KB			
Work memory, integrated	256 KB			
Work memory, maximal	512 KB			
Memory divided in 50% program / 50% data	✓			
Memory card slot	SD/MMC-Card with max. 2 GB			
Hardware configuration				
Racks, max.	1			
Modules per rack, max.	64			
Number of integrated DP master	1			
Number of DP master via CP	-			
Operable function modules	64			
Operable communication modules PtP	64			
Operable communication modules LAN	-			

CPUs CPU STEP7 programmable, PROFINET						
015-CEFP00						

Order number	015-CEFP00			
Command processing times				
Bit instructions, min.	0.01 µs			
Word instruction, min.	0.01 µs			
Double integer arithmetic, min.	0.01 µs			
Floating-point arithmetic, min.	0.06 µs			
Timers/Counters and their retentive characteristics				
Number of S7 counters	512			
S7 counter remanence	adjustable 0 up to 512			
S7 counter remanence adjustable	C0 .. C7			
Number of S7 times	512			
S7 times remanence	adjustable 0 up to 512			
S7 times remanence adjustable	not retentive			
Data range and retentive characteristic				
Number of flags	8192 Byte			
Bit memories retentive characteristic adjustable	adjustable 0 up to 8192			
Bit memories retentive characteristic preset	MB0 .. MB15			
Number of data blocks	4096			
Max. data blocks size	64 KB			
Number range DBs	1 ... 8191			
Max. local data size per execution level	4096 Byte			
Max. local data size per block	4096 Byte			
Blocks				
Number of OBs	24			
Maximum OB size	64 KB			
Total number DBs, FBs, FCs	4096			
Number of FBs	4096			
Maximum FB size	64 KB			
Number range FBs	0 ... 8191			
Number of FCs	4096			
Maximum FC size	64 KB			
Number range FC2	0 ... 8191			
Maximum nesting depth per priority class	16			
Maximum nesting depth additional within an error OB	4			
Time				
Real-time clock buffered	✓			
Clock buffered period (min.)	30 d			
Type of buffering	-			
Load time for 50% buffering period	15 min			
Load time for 100% buffering period	1 h			
Accuracy (max. deviation per day)	10 s			
Number of operating hours counter	8			
Clock synchronization	✓			
Synchronization via MPI	Master/Slave			

CPUs | CPUs STEP7 programmable, PROFINET

015-CEFPR00						
-------------	--	--	--	--	--	--

Order number	015-CEFPR00			
Synchronization via Ethernet (NTP)	Slave			
Address areas (I/O)				
Input I/O address area	2048 Byte			
Output I/O address area	2048 Byte			
Process image adjustable	✓			
Input process image preset	128 Byte			
Output process image preset	128 Byte			
Input process image maximal	2048 Byte			
Output process image maximal	2048 Byte			
Digital inputs	16384			
Digital outputs	16384			
Digital inputs central	512			
Digital outputs central	512			
Integrated digital inputs	-			
Integrated digital outputs	-			
Analog inputs	1024			
Analog outputs	1024			
Analog inputs, central	256			
Analog outputs, central	256			
Integrated analog inputs	-			
Integrated analog outputs	-			
Communication functions				
PG/OP channel	✓			
Global data communication	✓			
Number of GD circuits, max.	8			
Size of GD packets, max.	22 Byte			
S7 basic communication	✓			
S7 basic communication, user data per job	76 Byte			
S7 communication	✓			
S7 communication as server	✓			
S7 communication as client	-			
S7 communication, user data per job	160 Byte			
Number of connections, max.	32			
Functionality Sub-D interfaces				
Type	X2			
Type of interface	RS485			
Connector	Sub-D, 9-pin, female			
Electrically isolated	✓			
MPI	✓			
MP ² (MPI/RS232)	-			
DP master	-			
DP slave	-			
Point-to-point interface	✓			

CPUs CPUs STEP7 programmable, PROFINET						
015-CEFPR00						

Order number	015-CEFPR00			
Type	X3			
Type of interface	RS485			
Connector	Sub-D, 9-pin, female			
Electrically isolated	✓			
MPI	✓			
MP ² I (MPI/RS232)	-			
DP master	optional			
DP slave	optional			
Point-to-point interface	-			
Functionality MPI				
Number of connections, max.	32			
PG/OP channel	✓			
Routing	✓			
Global data communication	✓			
S7 basic communication	✓			
S7 communication	✓			
S7 communication as server	✓			
S7 communication as client	-			
Transmission speed, min.	19.2 kbit/s			
Transmission speed, max.	12 Mbit/s			
Functionality PROFIBUS master				
PG/OP channel	✓			
Routing	✓			
S7 basic communication	✓			
S7 communication	✓			
S7 communication as server	✓			
S7 communication as client	-			
Activation/deactivation of DP slaves	-			
Direct data exchange (slave-to-slave communication)	-			
DPV1	✓			
Transmission speed, min.	9.6 kbit/s			
Transmission speed, max.	12 Mbit/s			
Number of DP slaves, max.	124			
Address range inputs, max.	2 KB			
Address range outputs, max.	2 KB			
User data inputs per slave, max.	244 Byte			
User data outputs per slave, max.	244 Byte			
Functionality PROFIBUS slave				
PG/OP channel	✓			
Routing	✓			
S7 communication	✓			
S7 communication as server	✓			
S7 communication as client	-			

CPUs | CPUs STEP7 programmable, PROFINET

015-CEFP00					
------------	--	--	--	--	--

Order number	015-CEFP00			
Direct data exchange (slave-to-slave communication)	-			
DPV1	✓			
Transmission speed, min.	9.6 kbit/s			
Transmission speed, max.	12 Mbit/s			
Automatic detection of transmission speed	-			
Transfer memory inputs, max.	244 Byte			
Transfer memory outputs, max.	244 Byte			
Address areas, max.	32			
User data per address area, max.	32 Byte			
Point-to-point communication				
PtP communication	✓			
Interface isolated	✓			
RS232 interface	-			
RS422 interface	-			
RS485 interface	✓			
Connector	Sub-D, 9-pin, female			
Transmission speed, min.	150 bit/s			
Transmission speed, max.	115.5 kbit/s			
Cable length, max.	500 m			
Point-to-point protocol				
ASCII protocol	✓			
STX/ETX protocol	✓			
3964(R) protocol	✓			
RK512 protocol	-			
USS master protocol	✓			
Modbus master protocol	✓			
Modbus slave protocol	✓			
Special protocols	-			
Functionality PROFINET I/O controller				
Realtime Class	-			
Conformance Class	PROFINET IO			
Number of PN IO devices	128			
IRT support	-			
Prioritized start-up	-			
Number of PN IO lines	1			
Address range inputs, max.	2 KB			
Address range outputs, max.	2 KB			
Transmitting clock	1 ms			
Update time	1 ms .. 512 ms			
Functionality RJ45 interfaces				
Type	X1			
Type of interface	Ethernet 10/100 MBit			
Connector	RJ45			
Electrically isolated	✓			
PG/OP channel	✓			

CPUs CPUs STEP7 programmable, PROFINET						
015-CEFP00						

Order number	015-CEFP00			
Number of connections, max.	4			
Productive connections	-			
Type	X4			
Type of interface	Ethernet 10/100 MBit			
Connector	RJ45			
Electrically isolated	✓			
PG/OP channel	✓			
Number of connections, max.	8			
Productive connections	✓			
Ethernet communication CP				
Number of productive connections, max.	8			
Number of productive connections by Siemens NetPro, max.	8			
S7 connections	BSEND, BRCV, GET, PUT, Connection of active and passive data handling			
User data per S7 connection, max.	32 KB			
TCP-connections	FETCH PASSIV, WRITE PASSIV, Connection of passive data handling			
User data per TCP connection, max.	64 KB			
ISO-connections	-			
User data per ISO connection, max.	-			
ISO on TCP connections (RFC 1006)	FETCH PASSIV, WRITE PASSIV, Connection of passive data handling			
User data per ISO on TCP connection, max.	32 KB			
UDP-connections	-			
User data per UDP connection, max.	-			
UDP-multicast-connections	-			
UDP-broadcast-connections	-			
Ethernet open communication				
Number of connections, max.	8			
User data per ISO on TCP connection, max.	8 KB			
User data per native TCP connection, max.	8 KB			
User data per ad hoc TCP connection, max.	1460 Byte			
User data per UDP connection, max.	1472 Byte			
Housing				
Material	PPE			
Mounting	Profile rail 35 mm			

CPU CPUs STEP7 programmable, PROFINET						
015-CEFPR00						

Order number	015-CEFPR00			
Mechanical data				
Dimensions (WxHxD)	131.5 mm x 109 mm x 83 mm			
Weight	310 g			
Environmental conditions				
Operating temperature	0 °C to 60 °C			
Storage temperature	-25 °C to 70 °C			
Certifications				
UL508 certification	in preparation			

Connections, Interfaces

CPUs | CPUs STEP7 programmable, PROFINET

015-CEFP00					
------------	--	--	--	--	--

015-CEFP00

Dimensions:
 - Total width: 131.5 mm
 - Mounting rail width: 76.5 mm
 - Height (mounting rail): 104 mm
 - Height (CPU): 109 mm

Connection Diagrams:

- X1 PG/OP:**
 - 1 Transmit +
 - 2 Transmit -
 - 3 Receive +
 - 4 -
 - 5 -
 - 6 Receive -
 - 7 -
 - 8 -
- X2 PtP (MPI):**
 - 1 n.c.
 - 2 M24V
 - 3 RxD/TxD-P (line B)
 - 4 RTS
 - 5 M5V
 - 6 PSV
 - 7 P24V
 - 8 RxD/TxD-N (line A)
 - 9 n.c.
- X3 MPI (PB):**
 - 1 n.c.
 - 2 M24V
 - 3 RxD/TxD-P (line B)
 - 4 RTS
 - 5 M5V
 - 6 PSV
 - 7 P24V
 - 8 RxD/TxD-N (line A)
 - 9 n.c.
- X4 PN:**
 - 1 Transmit +
 - 2 Transmit -
 - 3 Receive +
 - 4 -
 - 5 -
 - 6 Receive -
 - 7 -
 - 8 -
- PM:**
 - 1 DC 24 V
 - 2 0 V
 - 3 Sys DC 24 V
 - 4 0 V
 - 5 0 V
 - 6 DC 24 V
 - 7 0 V
 - 8 0 V

Power modules

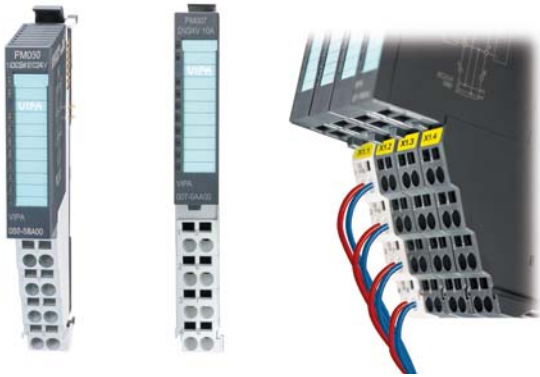

Structure and Function

In the system SLIO the power supply is provided via power modules.

Both the bus interface as well as the electronics of the connected peripheral modules are supplied with power via the power module (PM) integrated in interface module (IM). The DC 24 V load power supply for the connected peripheral modules is provided via a further connection in the PM.

With the help of color-contrasted power modules within the system further potential areas for the DC 24 V load power supply can be defined.

The two-component design allows for the easiest of service by separating the electronics from the terminal module.

Characteristics

- › Power supply of the sensor/actuator-level
- › Nominal input voltage DC 24 V
- › Output current max. 10 A
- › Isolation from potential groups
- › Front integrated status LEDs
- › Mounting security by reverse polarity and overvoltage protection
- › 24 months warranty



Overview

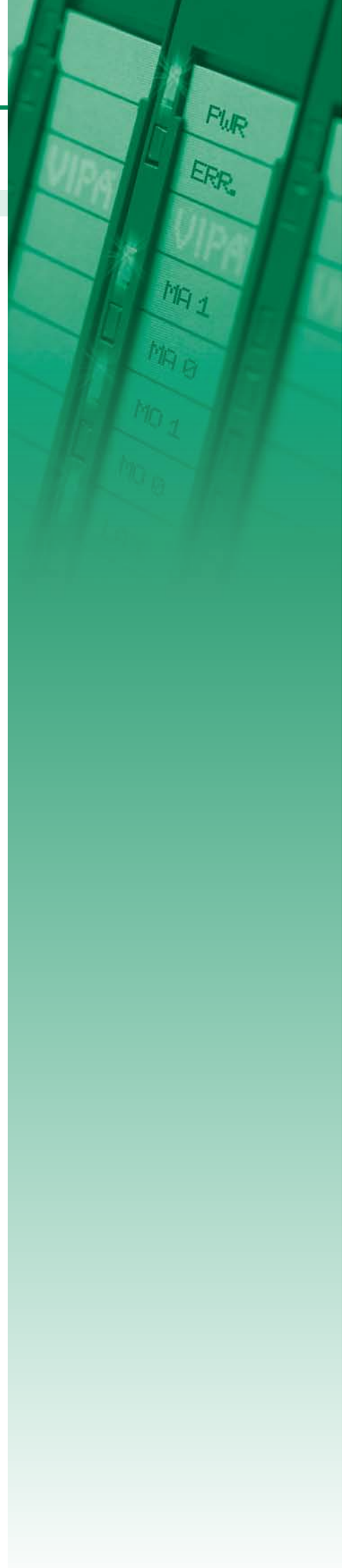

Order no.	Name/Description	Page
Power modules		
007-1AB00	PM 007 - Power module ▶ Power supply DC 24 V, 10 A ▶ Reverse polarity protection ▶ Overvoltage protection	38
007-1AB10	PM 007 - Power module ▶ Power supply DC 24 V, 4 A ▶ Power supply DC 24 V for bus supply 5 V, 2 A ▶ Reverse polarity protection ▶ Overvoltage protection	38



Power modules

Power modules | Power modules

007-1AB00
007-1AB10

Order number	007-1AB00	007-1AB10		
Figure				
Type	PM 007	PM 007		
Module ID	-	-		
General information				
Note	-	-		
Features	<ul style="list-style-type: none"> ▸ Power supply DC 24 V, 10 A ▸ Reverse polarity protection ▸ Overvoltage protection 	<ul style="list-style-type: none"> ▸ Power supply DC 24 V, 4 A ▸ Power supply DC 24 V for bus supply 5 V, 2 A ▸ Reverse polarity protection ▸ Overvoltage protection 		
Technical data power supply				
Input voltage (rated value)	DC 24 V	DC 24 V		
Input voltage (permitted range)	DC 20.4...28.8 V	DC 20.4...28.8 V		
Mains frequency (rated value)	-	-		
Mains frequency (permitted range)	-	-		
Input current (at 120 V)	-	-		
Input current (at 230 V)	-	-		
Inrush current	-	-		
Power consumption	-	-		
Output voltage (rated value)	24 V	24 V		
Output current (rated value)	10 A	4 A		
Power supply parallel switchable	-	-		
Reverse polarity protection	yes	yes		
Overvoltage protection	36 V	36 V		
Ripple of output voltage (max.)	-	-		
Efficiency	-	89 %		
Power loss	-	1.4 W		
Status information, alarms, diagnostics				
Status display	yes	yes		
Interrupts	no	no		
Process alarm	no	no		
Diagnostic interrupt	no	no		
Diagnostic functions	no	no		
Diagnostics information read-out	none	none		
Supply voltage display	green LED	green LED		
Group error display	red LED	red LED		
Channel error display	none	none		

Power modules Power modules						
007-1AB00 007-1AB10						

Order number	007-1AB00	007-1AB10		
Housing				
Material	PPE / PPE GF10	PPE / PPE GF10		
Mounting	Profile rail 35 mm	Profile rail 35 mm		
Mechanical data				
Dimensions (WxHxD)	12.9 mm x 109 mm x 76.5 mm	12.9 mm x 109 mm x 76.5 mm		
Weight	60 g	75 g		
Environmental conditions				
Operating temperature	0 °C to 60 °C	0 °C to 60 °C		
Storage temperature	-25 °C to 70 °C	-25 °C to 70 °C		
Certifications				
UL508 certification	yes	yes		

Connections, Interfaces

Power modules Power modules						
007-1AB00						
007-1AB10						

007-1AB00

Technical drawings for the 007-1AB00 power module. The drawings include a perspective view, a front view with dimensions (76.5, 10.4, 10.9, 12.9, 1.5, 1.33), and a terminal block diagram. The terminal block diagram shows 8 terminals: 1, 2, 3, 4, 5, 6, 7, 8. Connections are shown for DC24V (red) and 0V (blue) at terminals 2, 3, 6, and 7. A diode symbol is present between terminals 2 and 3.

007-1AB10

Technical drawings for the 007-1AB10 power module. The drawings include a perspective view, a front view with dimensions (76.5, 10.4, 10.9, 12.9, 1.5, 1.33), and a terminal block diagram. The terminal block diagram shows 8 terminals: 1, 2, 3, 4, 5, 6, 7, 8. Connections are shown for DC24V (red) and 0V (blue) at terminals 2, 3, 6, and 7. A diode symbol is present between terminals 2 and 3. Labels 'Sys DC24V' and 'DC24V' are present near the connections.

Signal modules digital



Structure and Function

Signal modules (SM) to connect sensors and actuators are the interfaces of the system to the process. Digital signal modules acquire the binary control signals to and from the process level.

A variety of different digital signal modules provides exactly the I/O modules, which are required for each task. The digital modules differ in the number of channels, voltage and current ranges, isolation, and diagnostic and alarm capability.

Each signal module consists of a terminal and an electronic module.

The terminal module (TM) contains the receptacle for the electronic module (EM), the backplane connectors and contacts for the distribution of the load power supply electronics, the modular connection to DC 24 V load power supply and the staircase-shaped terminal block for wiring.

Furthermore the terminal module processes a locking system for fixing to a profile rail. The SLIO system can also be constructed "block by block" outside the cabinet and later assembled as a complete system in the control cabinet.

The functionality of the signal module is defined via the electronics module that is connected by a secure sliding mechanism to the terminal module.

During service the defective electronic module can be replaced without detaching the wiring.

Characteristics

- › Electrically isolated digital inputs and outputs to the backplane bus
- › 2, 4 or 8 channel
- › Various modules, suitable for switches and proximity switches as well as for measuring transducers
- › Direct mapping and readability of the channel conditions via status LEDs
- › Safe and time-saving installation by the terminal assignment mounted on the module
- › When changing the module equipment identification (BMK) is retained on the TM
- › Individual single-channel lettering on insertion strip
- › 24 month warranty



Overview

Order no.	Name/Description	Page
Digital input modules		
021-1BB00	SM 021 - Digital input ‣ 2 inputs	45
021-1BB10	SM 021 - Digital input ‣ 2 fast inputs ‣ Input filter time delay parameterizable 2 µs...4 ms	45
021-1BB50	SM 021 - Digital input ‣ 2 inputs ‣ Active low input	45
021-1BB70	SM 021 - Digital input ‣ 2 inputs ‣ Time stamp	45
021-1BD00	SM 021 - Digital input ‣ 4 inputs	48
021-1BD10	SM 021 - Digital input ‣ 4 fast inputs ‣ Input filter time delay parameterizable 2 µs...4 ms	48
021-1BD40	SM 021 - Digital input ‣ 4 inputs ‣ Connect 2/3-wire	48
021-1BD50	SM 021 - Digital input ‣ 4 inputs ‣ Active low input	48
021-1BD70	SM 021 - Digital input ‣ 4 inputs ‣ Time stamp	51
021-1BF00	SM 021 - Digital input ‣ 8 inputs	51
021-1BF50	SM 021 - Digital input ‣ 8 inputs ‣ Active low input	51
021-1DF00	SM 021 - Digital input ‣ 8 inputs ‣ diagnosis of wiring errors	51
021-1SD00	SM 021 - Digital input ‣ 4 inputs ‣ Safety	54
Digital output modules		
022-1BB00	SM 022 - Digital output ‣ 2 outputs ‣ Output current 0.5 A	57
022-1BB20	SM 022 - Digital output ‣ 2 outputs ‣ Output current 2 A	57
022-1BB50	SM 022 - Digital output ‣ 2 Low-Side outputs ‣ Output current 0.5 A	57
022-1BB70	SM 022 - Digital output ‣ 2 outputs ‣ Time stamp ‣ Output current 0.5 A	57
022-1BB90	SM 022 - Digital output ‣ 2 outputs ‣ PWM	61
022-1BD00	SM 022 - Digital output ‣ 4 outputs ‣ Output current 0.5 A	61
022-1BD20	SM 022 - Digital output ‣ 4 outputs ‣ Output current 2 A	61
022-1BD50	SM 022 - Digital output ‣ 4 Low-Side outputs ‣ Output current 0.5 A	61
022-1BD70	SM 022 - Digital output ‣ 4 outputs ‣ Time stamp ‣ Output current 0.5 A	65

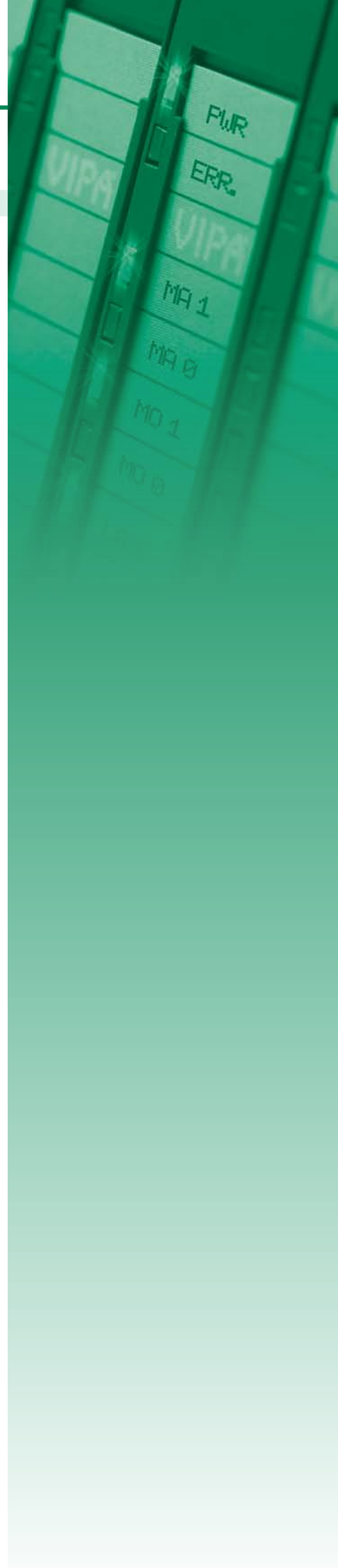

Overview



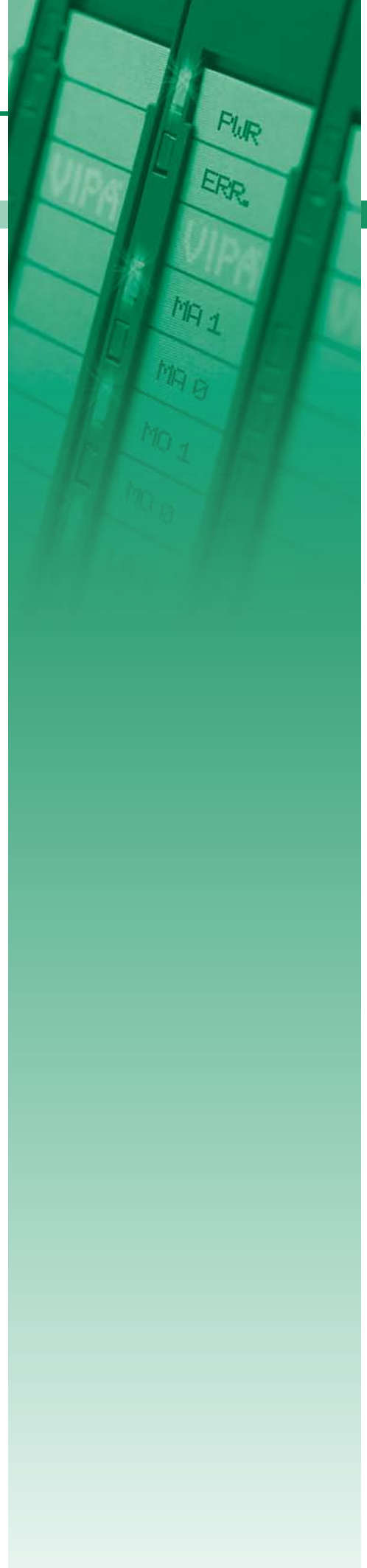

Order no.	Name/Description	Page
022-1BF00	SM 022 - Digital output ▶ 8 outputs ▶ Output current 0.5 A	65
022-1BF50	SM 022 - Digital output ▶ 8 Low-Side outputs ▶ Output current 0.5 A	65
022-1HB10	SM 022 - Digital output ▶ 2 relay outputs ▶ DC 30 V/ AC 230 V ▶ Output current 3 A	65
022-1DF00	SM 022 - Digital output ▶ 8 outputs ▶ Output current 0.5 A ▶ diagnosis of wiring errors	69
022-1SD00	SM 022 - Digital output ▶ 4 outputs ▶ Safety ▶ Output current 0.5 A	69



Digital input modules

Signal modules digital | Digital input modules

021-1BB00	021-1BD00	021-1BD70	021-1SD00			
021-1BB10	021-1BD10	021-1BF00				
021-1BB50	021-1BD40	021-1BF50				
021-1BB70	021-1BD50	021-1DF00				

Order number	021-1BB00	021-1BB10	021-1BB50	021-1BB70
Figure				
Type	SM 021	SM 021	SM 021	SM 021
Module ID	0001 9F82	000A 1F02	0002 9F82	0F01 47C1
General information				
Note	-	-	-	-
Features	<ul style="list-style-type: none"> ▸ 2 inputs 	<ul style="list-style-type: none"> ▸ 2 fast inputs ▸ Input filter time delay parameterizable 2 μs...4 ms 	<ul style="list-style-type: none"> ▸ 2 inputs ▸ Active low input 	<ul style="list-style-type: none"> ▸ 2 inputs ▸ Time stamp
Current consumption/power loss				
Current consumption from backplane bus	55 mA	95 mA	60 mA	85 mA
Power loss	0.5 W	0.9 W	0.5 W	0.9 W
Technical data digital inputs				
Number of inputs	2	2	2	2
Cable length, shielded	1000 m	1000 m	1000 m	1000 m
Cable length, unshielded	600 m	600 m	600 m	600 m
Rated load voltage	-	DC 20.4...28.8 V	-	DC 24 V
Current consumption from load voltage L+ (without load)	-	12 mA	-	10 mA
Rated value	DC 20.4...28.8 V	DC 20.4...28.8 V	DC 20.4...28.8 V	DC 20.4...28.8 V
Input voltage for signal "0"	DC 0...5 V	DC 0...5 V	DC 15...28.8 V	DC 0...5 V
Input voltage for signal "1"	DC 15...28.8 V	DC 15...28.8 V	DC 0...5 V	DC 15...28.8 V
Input voltage hysteresis	-	-	-	-
Frequency range	-	-	-	-
Input resistance	-	-	-	-
Input current for signal "1"	3 mA	3 mA	3 mA	3 mA
Connection of Two-Wire-BEROs possible	✓	✓	✓	✓
Max. permissible BERO quiescent current	0.5 mA	0.5 mA	0.5 mA	0.5 mA
Input delay of "0" to "1"	3 ms	parameterizable 2μs - 3ms	3 ms	parameterizable 2μs - 3ms
Input delay of "1" to "0"	3 ms	parameterizable 2μs - 3ms	3 ms	parameterizable 2μs - 3ms
Number of simultaneously utilizable inputs horizontal configuration	2	2	2	2
Number of simultaneously utilizable inputs vertical configuration	2	2	2	2
Input characteristic curve	IEC 61131-2, type 1	IEC 61131-2, type 1	-	IEC 61131-2, type 1
Initial data size	2 Bit	2 Bit	2 Bit	60 Byte

Signal modules digital | Digital input modules

021-1BB00	021-1BD00	021-1BD70	021-1SD00			
021-1BB10	021-1BD10	021-1BF00				
021-1BB50	021-1BD40	021-1BF50				
021-1BB70	021-1BD50	021-1DF00				

Order number	021-1BB00	021-1BB10	021-1BB50	021-1BB70
Status information, alarms, diagnostics				
Status display	green LED per channel	green LED per channel	green LED per channel	green LED per channel
Interrupts	no	yes, parameterizable	no	no
Process alarm	no	yes, parameterizable	no	no
Diagnostic interrupt	no	yes, parameterizable	no	no
Diagnostic functions	no	yes	no	no
Diagnostics information read-out	none	possible	none	possible
Module state	green LED	green LED	green LED	green LED
Module error display	red LED	red LED	red LED	red LED
Channel error display	none	none	none	none
Isolation				
Between channels	-	-	-	-
Between channels of groups to	-	-	-	-
Between channels and backplane bus	✓	✓	✓	✓
Insulation tested with	DC 500 V	DC 500 V	DC 500 V	DC 500 V
Safety				
Safety protocol	-	-	-	-
Safety requirements	-	-	-	-
Secure user address	-	-	-	-
Watchdog	-	-	-	-
Two channels	-	-	-	-
Test pulse outputs	-	-	-	-
Datasizes				
Input bytes	1	1	1	20 / 60
Output bytes	0	0	0	0
Parameter bytes	0	9	0	10
Diagnostic bytes	0	20	0	20
Housing				
Material	PPE / PPE GF10	PPE / PPE GF10	PPE / PPE GF10	PPE / PPE GF10
Mounting	Profile rail 35 mm	Profile rail 35 mm	Profile rail 35 mm	Profile rail 35 mm
Mechanical data				
Dimensions (WxHxD)	12.9 mm x 109 mm x 76.5 mm	12.9 mm x 109 mm x 76.5 mm	12.9 mm x 109 mm x 76.5 mm	12.9 mm x 109 mm x 76.5 mm
Weight	60 g	60 g	60 g	60 g
Environmental conditions				
Operating temperature	0 °C to 60 °C	0 °C to 60 °C	0 °C to 60 °C	0 °C to 60 °C
Storage temperature	-25 °C to 70 °C	-25 °C to 70 °C	-25 °C to 70 °C	-25 °C to 70 °C
Certifications				
UL508 certification	yes	yes	yes	yes

Connections, Interfaces

Signal modules digital | Digital input modules

021-1BB00	021-1BD00	021-1BD70	021-1SD00		
021-1BB10	021-1BD10	021-1BF00			
021-1BB50	021-1BD40	021-1BF50			
021-1BB70	021-1BD50	021-1DF00			

021-1BB00

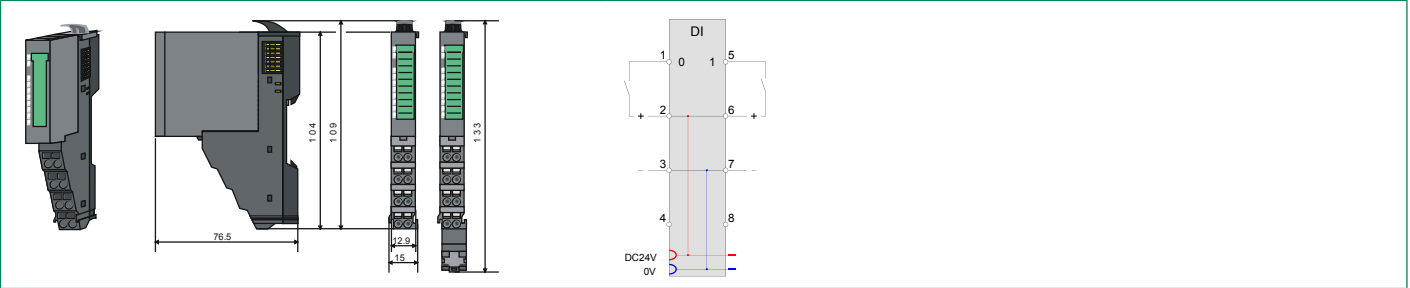

021-1BB10

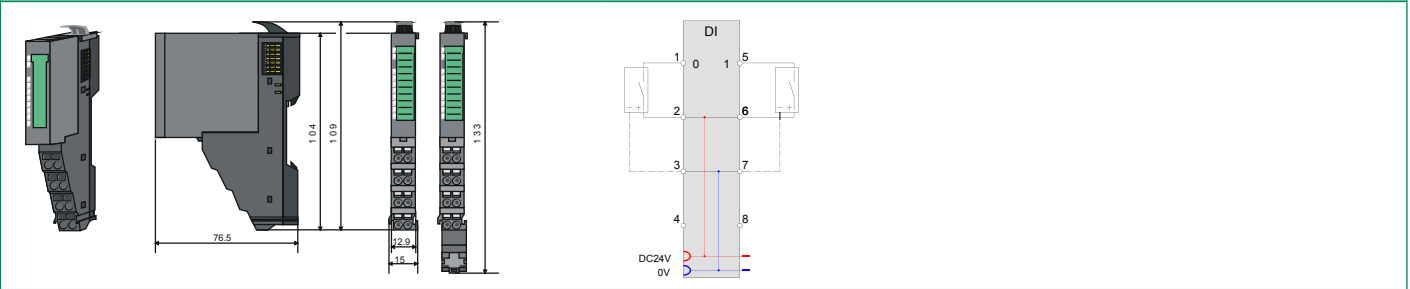

021-1BB50

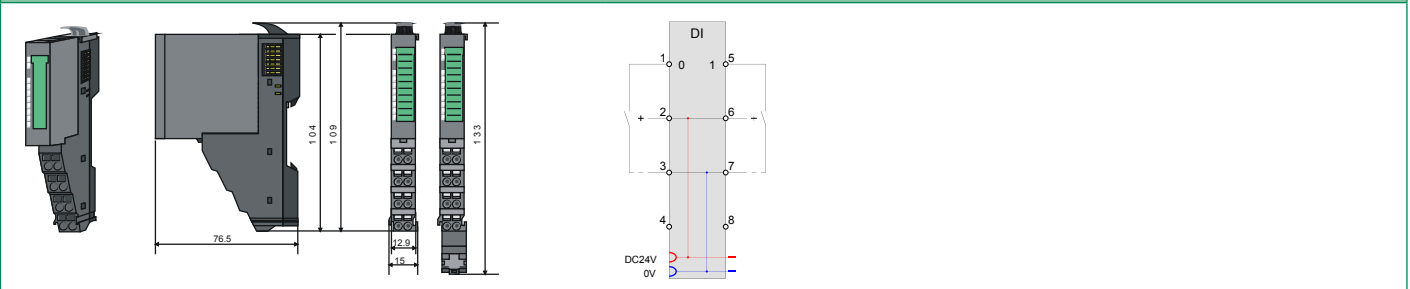



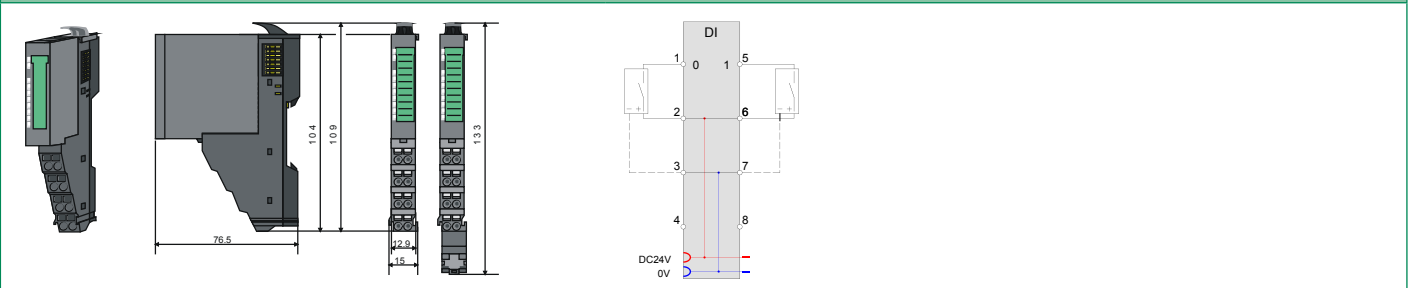

021-1BB70



Digital input modules

Signal modules digital | Digital input modules

021-1BB00	021-1BD00	021-1BD70	021-1SD00			
021-1BB10	021-1BD10	021-1BF00				
021-1BB50	021-1BD40	021-1BF50				
021-1BB70	021-1BD50	021-1DF00				

Order number	021-1BD00	021-1BD10	021-1BD40	021-1BD50
Figure				
Type	SM 021	SM 021	SM 021	SM 021
Module ID	0003 9F84	0009 1F04	0008 9F84	0004 9F84
General information				
Note	-	-	-	-
Features	<ul style="list-style-type: none"> ▸ 4 inputs 	<ul style="list-style-type: none"> ▸ 4 fast inputs ▸ Input filter time delay parameterizable 2 μs...4 ms 	<ul style="list-style-type: none"> ▸ 4 inputs ▸ Connect 2/3-wire 	<ul style="list-style-type: none"> ▸ 4 inputs ▸ Active low input
Current consumption/power loss				
Current consumption from backplane bus	55 mA	95 mA	55 mA	65 mA
Power loss	0.6 W	0.95 W	0.6 W	0.6 W
Technical data digital inputs				
Number of inputs	4	4	4	4
Cable length, shielded	1000 m	1000 m	1000 m	1000 m
Cable length, unshielded	600 m	600 m	600 m	600 m
Rated load voltage	-	DC 20.4...28.8 V	-	-
Current consumption from load voltage L+ (without load)	-	15 mA	-	-
Rated value	DC 20.4...28.8 V	DC 20.4...28.8 V	DC 20.4...28.8 V	DC 20.4...28.8 V
Input voltage for signal "0"	DC 0...5 V	DC 0...5 V	DC 0...5 V	DC 15...28.8 V
Input voltage for signal "1"	DC 15...28.8 V	DC 15...28.8 V	DC 15...28.8 V	DC 0...5 V
Input voltage hysteresis	-	-	-	-
Frequency range	-	-	-	-
Input resistance	-	-	-	-
Input current for signal "1"	3 mA	3 mA	3 mA	3 mA
Connection of Two-Wire-BEROs possible	✓	✓	✓	✓
Max. permissible BERO quiescent current	0.5 mA	0.5 mA	0.5 mA	0.5 mA
Input delay of "0" to "1"	3 ms	parameterizable 2 μs - 3ms	3 ms	3 ms
Input delay of "1" to "0"	3 ms	parameterizable 2 μs - 3ms	3 ms	3 ms
Number of simultaneously utilizable inputs horizontal configuration	4	4	4	4
Number of simultaneously utilizable inputs vertical configuration	4	4	4	4
Input characteristic curve	IEC 61131-2, type 1	IEC 61131-2, type 1	IEC 61131-2, type 1	-
Initial data size	4 Bit	4 Bit	4 Bit	4 Bit

Signal modules digital Digital input modules						
021-1BB00	021-1BD00	021-1BD70	021-1SD00			
021-1BB10	021-1BD10	021-1BF00				
021-1BB50	021-1BD40	021-1BF50				
021-1BB70	021-1BD50	021-1DF00				

Order number	021-1BD00	021-1BD10	021-1BD40	021-1BD50
Status information, alarms, diagnostics				
Status display	green LED per channel	green LED per channel	green LED per channel	green LED per channel
Interrupts	no	yes, parameterizable	no	no
Process alarm	no	yes, parameterizable	no	no
Diagnostic interrupt	no	yes, parameterizable	no	no
Diagnostic functions	no	yes	no	no
Diagnostics information read-out	none	possible	none	none
Module state	green LED	green LED	green LED	green LED
Module error display	red LED	red LED	red LED	red LED
Channel error display	none	none	none	none
Isolation				
Between channels	-	-	-	-
Between channels of groups to	-	-	-	-
Between channels and backplane bus	✓	✓	✓	✓
Insulation tested with	DC 500 V	DC 500 V	DC 500 V	DC 500 V
Safety				
Safety protocol	-	-	-	-
Safety requirements	-	-	-	-
Secure user address	-	-	-	-
Watchdog	-	-	-	-
Two channels	-	-	-	-
Test pulse outputs	-	-	-	-
Datasizes				
Input bytes	1	1	1	1
Output bytes	0	0	0	0
Parameter bytes	0	11	0	0
Diagnostic bytes	0	20	0	0
Housing				
Material	PPE / PPE GF10	PPE / PPE GF10	PPE / PPE GF10	PPE / PPE GF10
Mounting	Profile rail 35 mm	Profile rail 35 mm	Profile rail 35 mm	Profile rail 35 mm
Mechanical data				
Dimensions (WxHxD)	12.9 mm x 109 mm x 76.5 mm	12.9 mm x 109 mm x 76.5 mm	12.9 mm x 109 mm x 76.5 mm	12.9 mm x 109 mm x 76.5 mm
Weight	60 g	60 g	60 g	60 g
Environmental conditions				
Operating temperature	0 °C to 60 °C	0 °C to 60 °C	0 °C to 60 °C	0 °C to 60 °C
Storage temperature	-25 °C to 70 °C	-25 °C to 70 °C	-25 °C to 70 °C	-25 °C to 70 °C
Certifications				
UL508 certification	yes	yes	yes	yes

Connections, Interfaces

Signal modules digital Digital input modules					
021-1BB00	021-1BD00	021-1BD70	021-1SD00		
021-1BB10	021-1BD10	021-1BF00			
021-1BB50	021-1BD40	021-1BF50			
021-1BB70	021-1BD50	021-1DF00			

021-1BD00

Technical drawing of the 021-1BD00 module showing front, side, and rear views with dimensions: 76.5, 10.4, 10.9, 12.9, 15, and 13.3. A terminal block diagram shows 8 DI channels with connections for DC24V and 0V.

021-1BD10

Technical drawing of the 021-1BD10 module showing front, side, and rear views with dimensions: 76.5, 10.4, 10.9, 12.9, 15, and 13.3. A terminal block diagram shows 8 DI channels with connections for DC24V and 0V.

021-1BD40

Technical drawing of the 021-1BD40 module showing front, side, and rear views with dimensions: 76.5, 10.4, 10.9, 12.9, 15, and 13.3. A terminal block diagram shows 8 DI channels with connections for DC24V and 0V.





021-1BD50

Technical drawing of the 021-1BD50 module showing front, side, and rear views with dimensions: 76.5, 10.4, 10.9, 12.9, 15, and 13.3. A terminal block diagram shows 8 DI channels with connections for DC24V and 0V.

Digital input modules

Signal modules digital | Digital input modules

021-1BB00	021-1BD00	021-1BD70	021-1SD00			
021-1BB10	021-1BD10	021-1BF00				
021-1BB50	021-1BD40	021-1BF50				
021-1BB70	021-1BD50	021-1DF00				

Order number	021-1BD70	021-1BF00	021-1BF50	021-1DF00
Figure				
Type	SM 021	SM 021	SM 021	SM 021
Module ID	0F03 47C2	0005 9FC1	0007 9FC1	0012 1F41
General information				
Note	-	-	-	-
Features	<ul style="list-style-type: none"> ▸ 4 inputs ▸ Time stamp 	<ul style="list-style-type: none"> ▸ 8 inputs 	<ul style="list-style-type: none"> ▸ 8 inputs ▸ Active low input 	<ul style="list-style-type: none"> ▸ 8 inputs ▸ diagnosis of wiring errors
Current consumption/power loss				
Current consumption from backplane bus	85 mA	60 mA	65 mA	60 mA
Power loss	0.95 W	0.9 W	0.9 W	1.1 W
Technical data digital inputs				
Number of inputs	4	8	8	8
Cable length, shielded	1000 m	1000 m	1000 m	1000 m
Cable length, unshielded	600 m	600 m	600 m	600 m
Rated load voltage	DC 24 V	-	-	-
Current consumption from load voltage L+ (without load)	15 mA	-	-	-
Rated value	DC 20.4...28.8 V	DC 20.4...28.8 V	DC 20.4...28.8 V	DC 20.4...28.8 V
Input voltage for signal "0"	DC 0...5 V	DC 0...5 V	DC 15...28.8 V	DC 0...5 V
Input voltage for signal "1"	DC 15...28.8 V	DC 15...28.8 V	DC 0...5 V	DC 10,8...28,8 V
Input voltage hysteresis	-	-	-	-
Frequency range	-	-	-	-
Input resistance	-	-	-	-
Input current for signal "1"	3 mA	3 mA	3 mA	3 mA
Connection of Two-Wire-BEROs possible	✓	✓	✓	✓
Max. permissible BERO quiescent current	0.5 mA	0.5 mA	0.5 mA	1.5 mA
Input delay of "0" to "1"	parameterizable 2µs - 3ms	3 ms	3 ms	parameterizable 100µs - 20ms
Input delay of "1" to "0"	parameterizable 2µs - 3ms	3 ms	3 ms	parameterizable 100µs - 20ms
Number of simultaneously utilizable inputs horizontal configuration	4	8	8	8
Number of simultaneously utilizable inputs vertical configuration	4	8	8	8
Input characteristic curve	IEC 61131-2, type 1	IEC 61131-2, type 1	-	IEC 61131-2, type 3
Initial data size	60 Byte	8 Bit	8 Bit	8 Bit

Signal modules digital | Digital input modules

021-1BB00	021-1BD00	021-1BD70	021-1SD00			
021-1BB10	021-1BD10	021-1BF00				
021-1BB50	021-1BD40	021-1BF50				
021-1BB70	021-1BD50	021-1DF00				

Order number	021-1BD70	021-1BF00	021-1BF50	021-1DF00
Status information, alarms, diagnostics				
Status display	green LED per channel	green LED per channel	green LED per channel	green LED per channel
Interrupts	no	no	no	yes
Process alarm	no	no	no	no
Diagnostic interrupt	no	no	no	yes, parameterizable
Diagnostic functions	no	no	no	yes
Diagnostics information read-out	possible	none	none	possible
Module state	green LED	green LED	green LED	green LED
Module error display	red LED	red LED	red LED	red LED
Channel error display	none	none	none	none
Isolation				
Between channels	-	-	-	-
Between channels of groups to	-	-	-	-
Between channels and backplane bus	✓	✓	✓	✓
Insulation tested with	DC 500 V	DC 500 V	DC 500 V	DC 500 V
Safety				
Safety protocol	-	-	-	-
Safety requirements	-	-	-	-
Secure user address	-	-	-	-
Watchdog	-	-	-	-
Two channels	-	-	-	-
Test pulse outputs	-	-	-	-
Datasizes				
Input bytes	20 / 60	1	1	1
Output bytes	0	0	0	0
Parameter bytes	12	0	0	12
Diagnostic bytes	20	0	0	20
Housing				
Material	PPE / PPE GF10	PPE / PPE GF10	PPE / PPE GF10	PPE / PPE GF10
Mounting	Profile rail 35 mm	Profile rail 35 mm	Profile rail 35 mm	Profile rail 35 mm
Mechanical data				
Dimensions (WxHxD)	12.9 mm x 109 mm x 76.5 mm	12.9 mm x 109 mm x 76.5 mm	12.9 mm x 109 mm x 76.5 mm	12.9 mm x 109 mm x 76.5 mm
Weight	60 g	60 g	60 g	60 g
Environmental conditions				
Operating temperature	0 °C to 60 °C	0 °C to 60 °C	0 °C to 60 °C	0 °C to 60 °C
Storage temperature	-25 °C to 70 °C	-25 °C to 70 °C	-25 °C to 70 °C	-25 °C to 70 °C
Certifications				
UL508 certification	yes	yes	yes	in preparation

Connections, Interfaces

Signal modules digital | Digital input modules

021-1BB00 021-1BB10 021-1BB50 021-1BB70	021-1BD00 021-1BD10 021-1BD40 021-1BD50	021-1BD70 021-1BF00 021-1BF50 021-1DF00	021-1SD00		
--	--	--	-----------	--	--

021-1BD70

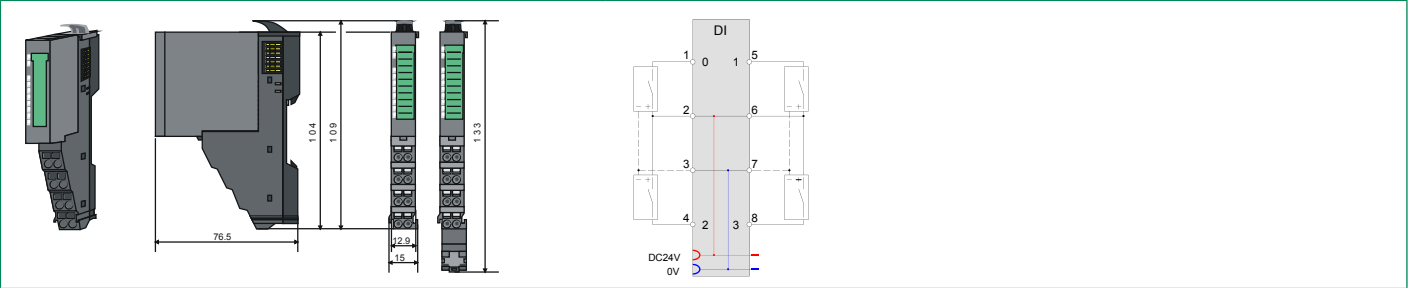

021-1BF00

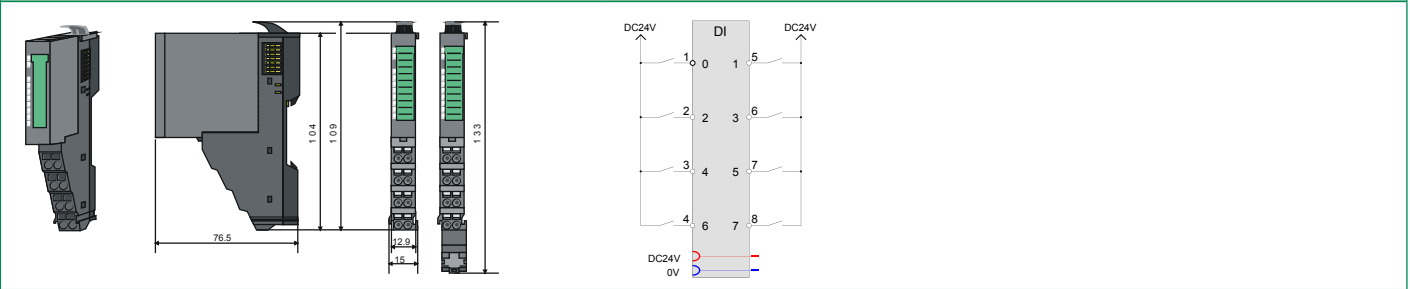

021-1BF50

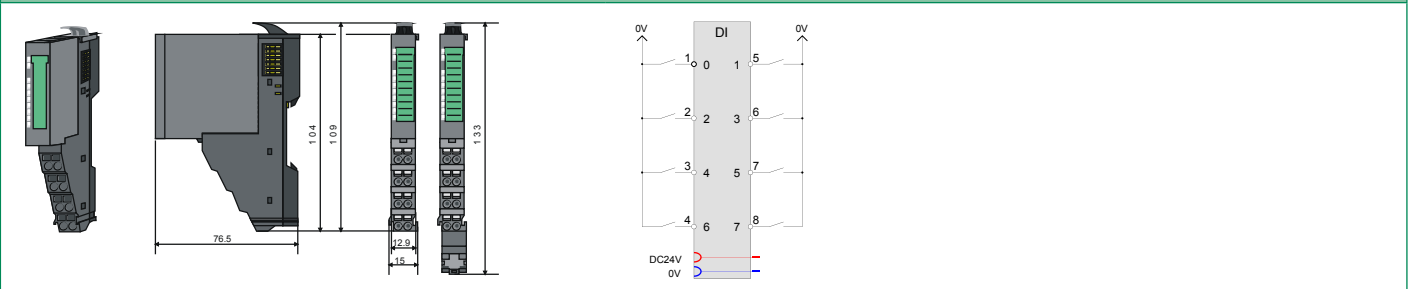

021-1DF00

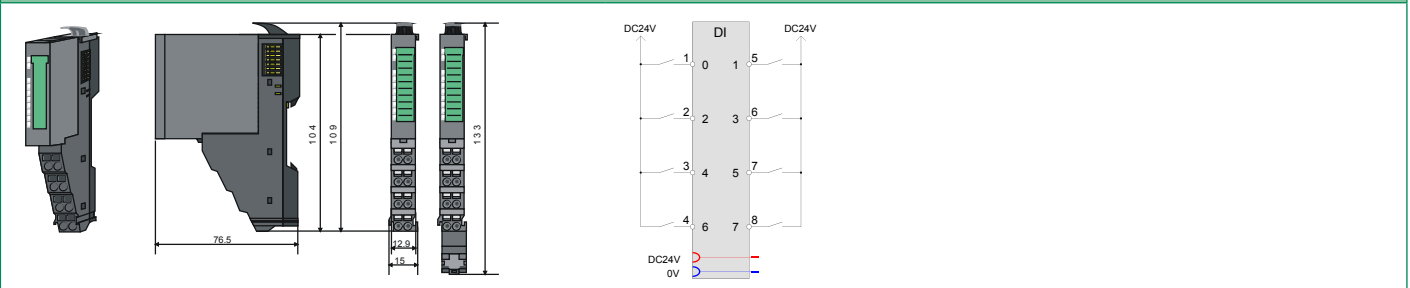

Digital input modules

Signal modules digital | Digital input modules

021-1BB00	021-1BD00	021-1BD70	021-1SD00			
021-1BB10	021-1BD10	021-1BF00				
021-1BB50	021-1BD40	021-1BF50				
021-1BB70	021-1BD50	021-1DF00				

Order number	021-1SD00			
Figure				
Type	SM 021			
Module ID	OC41 2E00			
General information				
Note	-			
Features	<ul style="list-style-type: none"> ▸ 4 inputs ▸ Safety 			
Current consumption/power loss				
Current consumption from backplane bus	95 mA			
Power loss	0.8 W			
Technical data digital inputs				
Number of inputs	4			
Cable length, shielded	330 m			
Cable length, unshielded	330 m			
Rated load voltage	-			
Current consumption from load voltage L+ (without load)	2 mA			
Rated value	DC 20.4...28.8 V			
Input voltage for signal "0"	DC 0...5 V			
Input voltage for signal "1"	DC 11...28.8 V			
Input voltage hysteresis	-			
Frequency range	-			
Input resistance	-			
Input current for signal "1"	3 mA			
Connection of Two-Wire-BEROs possible	✓			
Max. permissible BERO quiescent current	1.5 mA			
Input delay of "0" to "1"	parameterizable 1ms - 1s			
Input delay of "1" to "0"	parameterizable 1ms - 1s			
Number of simultaneously utilizable inputs horizontal configuration	4			
Number of simultaneously utilizable inputs vertical configuration	4			
Input characteristic curve	IEC 61131-2, type 3			
Initial data size	4 Bit			

Signal modules digital Digital input modules						
021-1BB00	021-1BD00	021-1BD70	021-1SD00			
021-1BB10	021-1BD10	021-1BF00				
021-1BB50	021-1BD40	021-1BF50				
021-1BB70	021-1BD50	021-1DF00				

Order number	021-1SD00			
Status information, alarms, diagnostics				
Status display	green LED per channel			
Interrupts	yes, parameterizable			
Process alarm	no			
Diagnostic interrupt	yes, parameterizable			
Diagnostic functions	yes, parameterizable			
Diagnostics information read-out	possible			
Module state	green LED			
Module error display	red LED			
Channel error display	red ERR-LED and yellow ER2-LED			
Isolation				
Between channels	-			
Between channels of groups to	-			
Between channels and backplane bus	✓			
Insulation tested with	DC 500 V			
Safety				
Safety protocol	PROFIsafe V2			
Safety requirements	SIL CL 3, PL e, Kat 4			
Secure user address	1 - 4095			
Watchdog	parameterizable 10ms - 1s			
Two channels	Each 2 of 4 inputs switchable			
Test pulse outputs	4			
Datasizes				
Input bytes	5			
Output bytes	5			
Parameter bytes	44			
Diagnostic bytes	20			
Housing				
Material	PC / PPE GF10			
Mounting	Profile rail 35 mm			
Mechanical data				
Dimensions (WxHxD)	12.9 mm x 109 mm x 76.5 mm			
Weight	60 g			
Environmental conditions				
Operating temperature	0 °C to 60 °C			
Storage temperature	-25 °C to 70 °C			
Certifications				
UL508 certification	in preparation			

Connections, Interfaces

Signal modules digital Digital input modules					
021-1BB00	021-1BD00	021-1BD70	021-1SD00		
021-1BB10	021-1BD10	021-1BF00			
021-1BB50	021-1BD40	021-1BF50			
021-1BB70	021-1BD50	021-1DF00			





021-1SD00

The technical drawing shows the 021-1SD00 module from multiple perspectives. The front view shows a yellow module with a terminal block on the right. The side view shows the module's profile with dimensions: 76.5 mm width, 104 mm height to the top of the terminal block, and 109 mm height to the top of the main module body. The terminal block diagram shows 8 pins numbered 1 to 8. Pins 1, 2, 3, and 4 are grouped together. Pins 5, 6, 7, and 8 are grouped together. The DC24V connection is shown with a red wire and the 0V connection with a blue wire.

Digital output modules

Signal modules digital | Digital output modules

022-1BB00 022-1BB20 022-1BB50 022-1BB70	022-1BB90 022-1BD00 022-1BD20 022-1BD50	022-1BD70 022-1BF00 022-1BF50 022-1HB10	022-1DF00 022-1SD00		
--	--	--	------------------------	--	--

Order number	022-1BB00	022-1BB20	022-1BB50	022-1BB70
Figure				
Type	SM 022	SM 022	SM 022	SM 022
Module ID	0101 AF90	0102 AF90	0103 AF90	0F41 57E1
General information				
Note	-	-	-	-
Features	<ul style="list-style-type: none"> ▸ 2 outputs ▸ Output current 0.5 A 	<ul style="list-style-type: none"> ▸ 2 outputs ▸ Output current 2 A 	<ul style="list-style-type: none"> ▸ 2 Low-Side outputs ▸ Output current 0.5 A 	<ul style="list-style-type: none"> ▸ 2 outputs ▸ Time stamp ▸ Output current 0.5 A
Current consumption/power loss				
Current consumption from backplane bus	55 mA	60 mA	60 mA	85 mA
Power loss	0.4 W	0.55 W	0.4 W	0.95 W
Technical data digital outputs				
Number of outputs	2	2	2	2
Cable length, shielded	1000 m	1000 m	1000 m	1000 m
Cable length, unshielded	600 m	600 m	600 m	600 m
Rated load voltage	DC 20.4...28.8 V	DC 20.4...28.8 V	DC 20.4...28.8 V	DC 20.4...28.8 V
Current consumption from load voltage L+ (without load)	5 mA	10 mA	2.5 mA	15 mA
Total current per group, horizontal configuration, 40°C	1 A	4 A	1 A	1 A
Total current per group, horizontal configuration, 60°C	1 A	4 A	1 A	1 A
Total current per group, vertical configuration	1 A	4 A	1 A	1 A
Output current at signal "1", rated value	0.5 A	2 A	0.5 A	0.5 A
Output delay of "0" to "1"	30 µs	100 µs	30 µs	max. 100 ns
Output delay of "1" to "0"	175 µs	250 µs	100 µs	max. 100 ns
Minimum load current	-	-	-	-
Lamp load	10 W	10 W	10 W	10 W
Parallel switching of outputs for redundant control of a load	not possible	not possible	not possible	not possible
Parallel switching of outputs for increased power	not possible	not possible	not possible	not possible
Actuation of digital input	✓	✓	✓	✓
Switching frequency with resistive load	max. 1000 Hz	max. 1000 Hz	max. 1000 Hz	max. 40 kHz
Switching frequency with inductive load	max. 0.5 Hz	max. 0.5 Hz	max. 0.5 Hz	max. 40 kHz
Switching frequency on lamp load	max. 10 Hz	max. 10 Hz	max. 10 Hz	max. 40 kHz
Internal limitation of inductive shut-off voltage	L+ (-45 V)	L+ (-52 V)	+45 V	L+ (-52 V)
Short-circuit protection of output	yes, electronic	yes, electronic	yes, electronic	yes, electronic, and only highside
Trigger level	1 A	2.7 A	1.7 A	2.5 A
Number of operating cycle of relay outputs	-	-	-	-

Signal modules digital Digital output modules						
022-1BB00	022-1BB90	022-1BD70	022-1DF00			
022-1BB20	022-1BD00	022-1BF00	022-1SD00			
022-1BB50	022-1BD20	022-1BF50				
022-1BB70	022-1BD50	022-1HB10				

Order number	022-1BB00	022-1BB20	022-1BB50	022-1BB70
Switching capacity of contacts	-	-	-	-
Output data size	2 Bit	2 Bit	2 Bit	60 Byte
Status information, alarms, diagnostics				
Status display	green LED per channel	green LED per channel	green LED per channel	green LED per channel
Interrupts	no	no	no	no
Process alarm	no	no	no	no
Diagnostic interrupt	no	no	no	no
Diagnostic functions	no	no	no	no
Diagnostics information read-out	none	none	none	possible
Supply voltage display	green LED	green LED	green LED	green LED
Group error display	red LED	red LED	red LED	red LED
Channel error display	none	none	none	none
Isolation				
Between channels	-	-	-	-
Between channels of groups to	-	-	-	-
Between channels and backplane bus	✓	✓	✓	✓
Insulation tested with	DC 500 V	DC 500 V	DC 500 V	DC 500 V
PWM data				
PWM channels	-	-	-	-
PWM time basis	-	-	-	-
Period length	-	-	-	-
Minimum pulse width	-	-	-	-
PtP communication	-	-	-	-
Safety				
Safety protocol	-	-	-	-
Safety requirements	-	-	-	-
Secure user address	-	-	-	-
Watchdog	-	-	-	-
Two channels	-	-	-	-
Test pulse length	-	-	-	-
Circuit monitoring	-	-	-	-
Datasizes				
Input bytes	0	0	0	4
Output bytes	1	1	1	20 / 60
Parameter bytes	0	0	0	6
Diagnostic bytes	0	0	0	20

Signal modules digital Digital output modules						
022-1BB00	022-1BB90	022-1BD70	022-1DF00			
022-1BB20	022-1BD00	022-1BF00	022-1SD00			
022-1BB50	022-1BD20	022-1BF50				
022-1BB70	022-1BD50	022-1HB10				

Order number	022-1BB00	022-1BB20	022-1BB50	022-1BB70
Housing				
Material	PPE / PPE GF10	PPE / PPE GF10	PPE / PPE GF10	PPE / PPE GF10
Mounting	Profile rail 35 mm	Profile rail 35 mm	Profile rail 35 mm	Profile rail 35 mm
Mechanical data				
Dimensions (WxHxD)	12.9 mm x 109 mm x 76.5 mm	12.9 mm x 109 mm x 76.5 mm	12.9 mm x 109 mm x 76.5 mm	12.9 mm x 109 mm x 76.5 mm
Weight	60 g	60 g	60 g	60 g
Environmental conditions				
Operating temperature	0 °C to 60 °C	0 °C to 60 °C	0 °C to 60 °C	0 °C to 60 °C
Storage temperature	-25 °C to 70 °C	-25 °C to 70 °C	-25 °C to 70 °C	-25 °C to 70 °C
Certifications				
UL508 certification	yes	yes	yes	yes

Connections, Interfaces

Signal modules digital | Digital output modules

022-1BB00	022-1BB90	022-1BD70	022-1DF00		
022-1BB20	022-1BD00	022-1BF00	022-1SD00		
022-1BB50	022-1BD20	022-1BF50			
022-1BB70	022-1BD50	022-1HB10			

022-1BB00

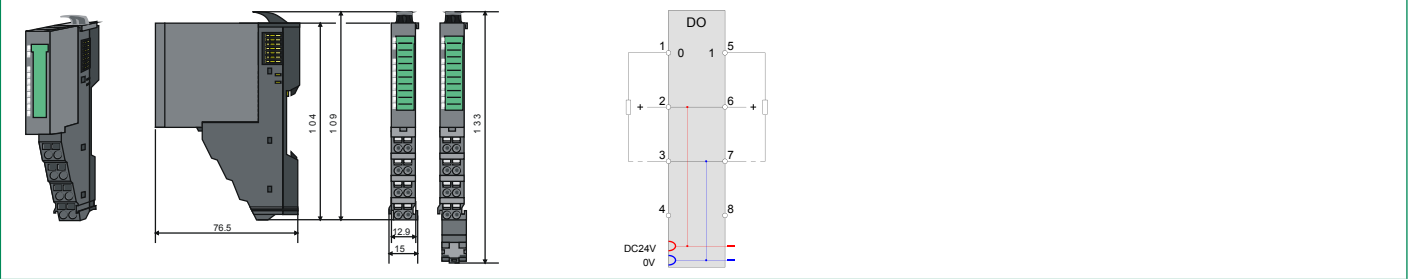

022-1BB20

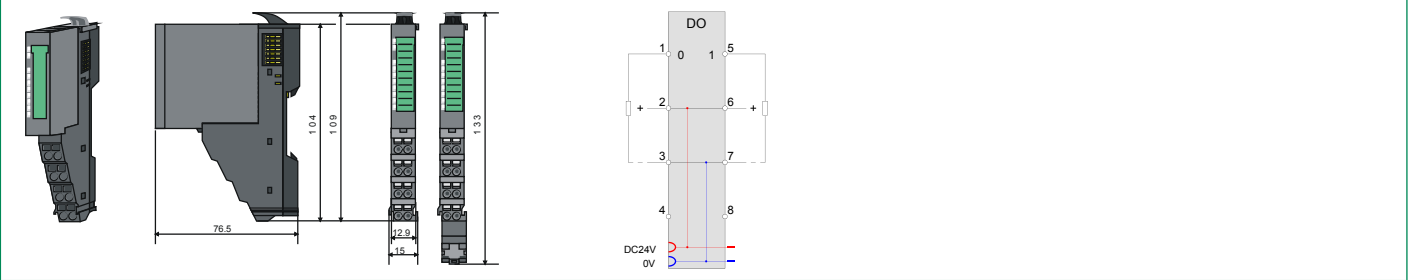

022-1BB50

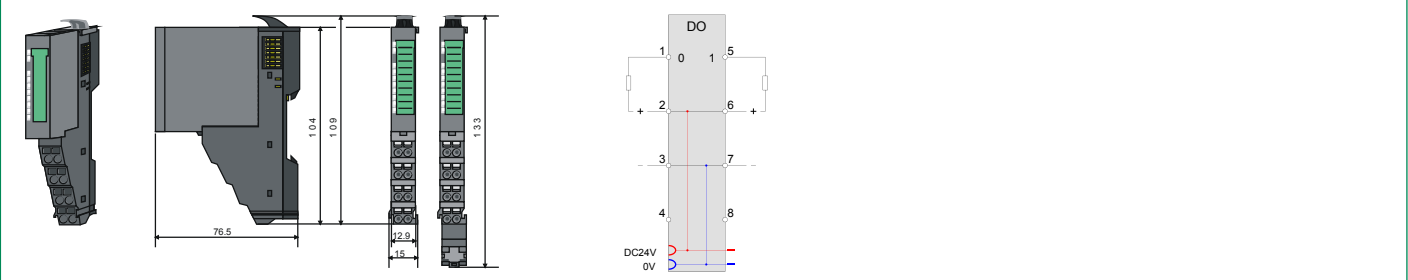



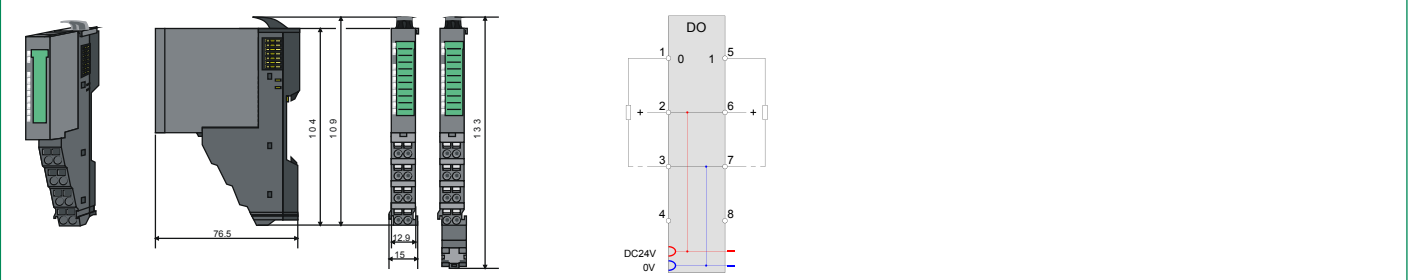

022-1BB70



Digital output modules

Signal modules digital | Digital output modules

022-1BB00 022-1BB20 022-1BB50 022-1BB70	022-1BB90 022-1BD00 022-1BD20 022-1BD50	022-1BD70 022-1BF00 022-1BF50 022-1HB10	022-1DF00 022-1SD00			
--	--	--	------------------------	--	--	--

Order number	022-1BB90	022-1BD00	022-1BD20	022-1BD50
Figure				
Type	SM 022	SM 022	SM 022	SM 022
Module ID	0901 4880	0104 AFA0	0108 AFA0	0105 AFA0
General information				
Note	-	-	-	-
Features	<ul style="list-style-type: none"> ▸ 2 outputs ▸ PWM 	<ul style="list-style-type: none"> ▸ 4 outputs ▸ Output current 0.5 A 	<ul style="list-style-type: none"> ▸ 4 outputs ▸ Output current 2 A 	<ul style="list-style-type: none"> ▸ 4 Low-Side outputs ▸ Output current 0.5 A
Current consumption/power loss				
Current consumption from backplane bus	85 mA	55 mA	65 mA	65 mA
Power loss	0.95 W	0.5 W	0.8 W	0.5 W
Technical data digital outputs				
Number of outputs	2	4	4	4
Cable length, shielded	1000 m	1000 m	1000 m	1000 m
Cable length, unshielded	600 m	600 m	600 m	600 m
Rated load voltage	DC 20.4...28.8 V	DC 20.4...28.8 V	DC 20.4...28.8 V	DC 20.4...28.8 V
Current consumption from load voltage L+ (without load)	15 mA	10 mA	20 mA	5 mA
Total current per group, horizontal configuration, 40°C	1 A	2 A	4 A	2 A
Total current per group, horizontal configuration, 60°C	1 A	2 A	4 A	2 A
Total current per group, vertical configuration	1 A	2 A	4 A	2 A
Output current at signal "1", rated value	0.5 A	0.5 A	2 A	0.5 A
Output delay of "0" to "1"	max. 100 ns	30 µs	100 µs	30 µs
Output delay of "1" to "0"	max. 100 ns	175 µs	250 µs	100 µs
Minimum load current	-	-	-	-
Lamp load	10 W	10 W	10 W	10 W
Parallel switching of outputs for redundant control of a load	not possible	not possible	not possible	not possible
Parallel switching of outputs for increased power	not possible	not possible	not possible	not possible
Actuation of digital input	✓	✓	✓	✓
Switching frequency with resistive load	max. 40 kHz	max. 1000 Hz	max. 1000 Hz	max. 1000 Hz
Switching frequency with inductive load	max. 40 kHz	max. 0.5 Hz	max. 0.5 Hz	max. 0.5 Hz
Switching frequency on lamp load	max. 40 kHz	max. 10 Hz	max. 10 Hz	max. 10 Hz
Internal limitation of inductive shut-off voltage	L+ (-52 V)	L+ (-45 V)	L+ (-52 V)	+45 V
Short-circuit protection of output	yes, electronic, and only highside	yes, electronic	yes, electronic	yes, electronic
Trigger level	2.5 A	1 A	2.7 A	1.7 A
Number of operating cycle of relay outputs	-	-	-	-
Switching capacity of contacts	-	-	-	-

Signal modules digital Digital output modules						
022-1BB00	022-1BB90	022-1BD70	022-1DF00			
022-1BB20	022-1BD00	022-1BF00	022-1SD00			
022-1BB50	022-1BD20	022-1BF50				
022-1BB70	022-1BD50	022-1HB10				

Order number	022-1BB90	022-1BD00	022-1BD20	022-1BD50
Output data size	12 Byte	4 Bit	4 Bit	4 Bit
Status information, alarms, diagnostics				
Status display	green LED per channel	green LED per channel	green LED per channel	green LED per channel
Interrupts	no	no	no	no
Process alarm	no	no	no	no
Diagnostic interrupt	no	no	no	no
Diagnostic functions	no	no	no	no
Diagnostics information read-out	possible	none	none	none
Supply voltage display	green LED	green LED	green LED	green LED
Group error display	red LED	red SF LED	red SF LED	red SF LED
Channel error display	none	none	none	none
Isolation				
Between channels	-	-	-	-
Between channels of groups to	-	-	-	-
Between channels and backplane bus	✓	✓	✓	✓
Insulation tested with	DC 500 V	DC 500 V	DC 500 V	DC 500 V
PWM data				
PWM channels	2	-	-	-
PWM time basis	-	-	-	-
Period length	-	-	-	-
Minimum pulse width	1 µs	-	-	-
PtP communication	-	-	-	-
Safety				
Safety protocol	-	-	-	-
Safety requirements	-	-	-	-
Secure user address	-	-	-	-
Watchdog	-	-	-	-
Two channels	-	-	-	-
Test pulse length	-	-	-	-
Circuit monitoring	-	-	-	-
Datasizes				
Input bytes	4	0	0	0
Output bytes	12	1	1	1
Parameter bytes	12	0	0	0
Diagnostic bytes	20	0	0	0

Signal modules digital | Digital output modules

022-1BB00	022-1BB90	022-1BD70	022-1DF00			
022-1BB20	022-1BD00	022-1BF00	022-1SD00			
022-1BB50	022-1BD20	022-1BF50				
022-1BB70	022-1BD50	022-1HB10				

Order number	022-1BB90	022-1BD00	022-1BD20	022-1BD50
Housing				
Material	PPE / PPE GF10	PPE / PPE GF10	PPE / PPE GF10	PPE / PPE GF10
Mounting	Profile rail 35 mm	Profile rail 35 mm	Profile rail 35 mm	Profile rail 35 mm
Mechanical data				
Dimensions (WxHxD)	12.9 mm x 109 mm x 76.5 mm	12.9 mm x 109 mm x 76.5 mm	12.9 mm x 109 mm x 76.5 mm	12.9 mm x 109 mm x 76.5 mm
Weight	60 g	60 g	60 g	60 g
Environmental conditions				
Operating temperature	0 °C to 60 °C	0 °C to 60 °C	0 °C to 60 °C	0 °C to 60 °C
Storage temperature	-25 °C to 70 °C	-25 °C to 70 °C	-25 °C to 70 °C	-25 °C to 70 °C
Certifications				
UL508 certification	yes	yes	yes	yes

Connections, Interfaces

Signal modules digital | Digital output modules

022-1BB00 022-1BB20 022-1BB50 022-1BB70	022-1BB90 022-1BD00 022-1BD20 022-1BD50	022-1BD70 022-1BF00 022-1BF50 022-1HB10	022-1DF00 022-1SD00			
--	--	--	------------------------	--	--	--

022-1BB90

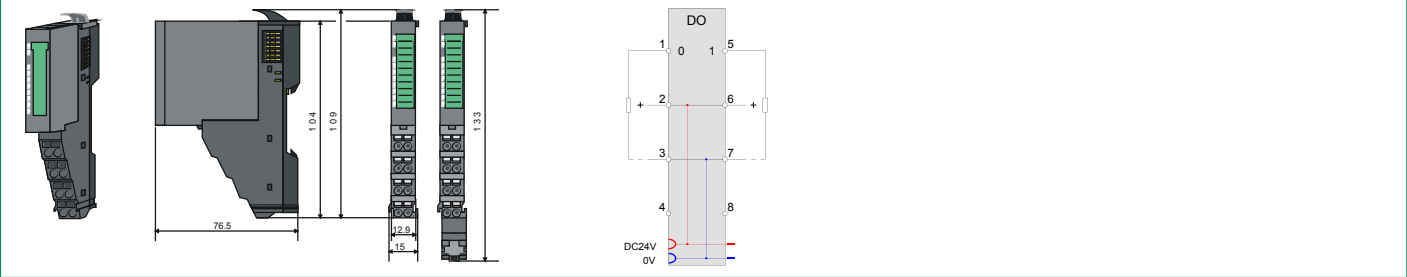

022-1BD00

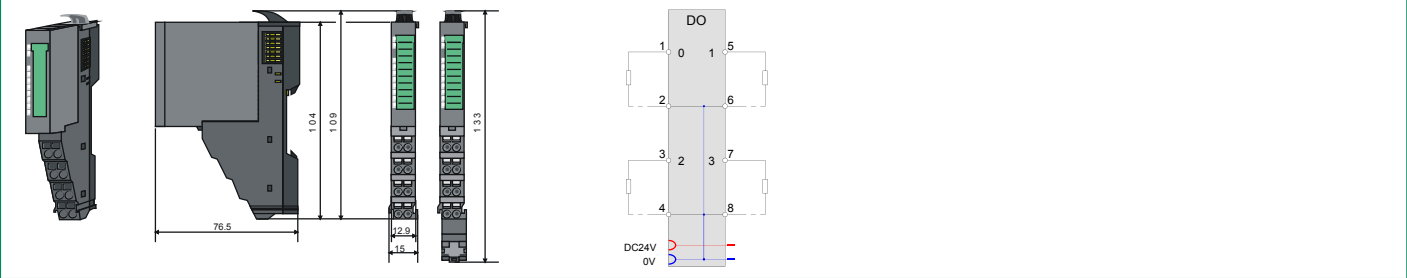

022-1BD20

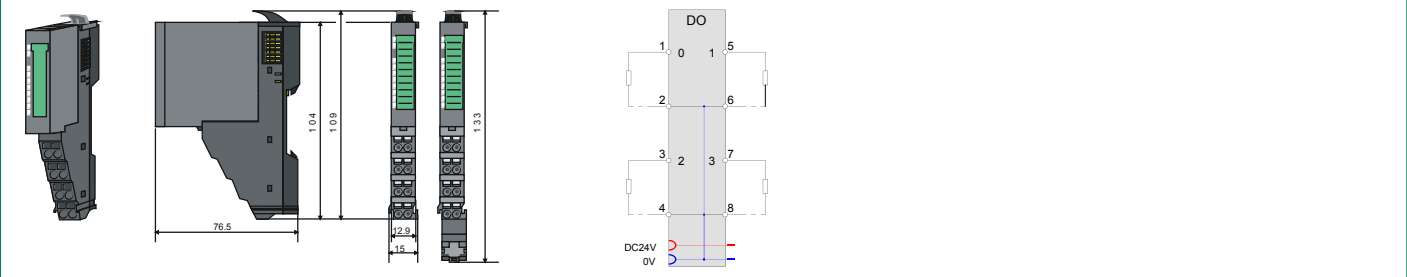



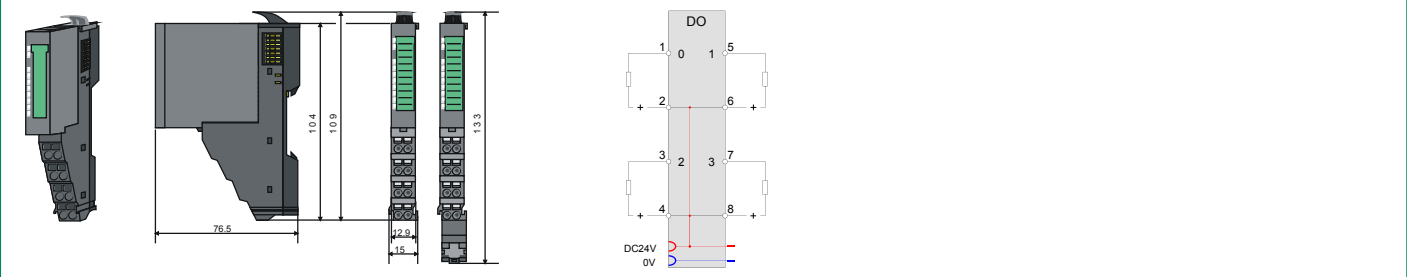

022-1BD50



Digital output modules

Signal modules digital | Digital output modules

022-1BB00 022-1BB20 022-1BB50 022-1BB70	022-1BB90 022-1BD00 022-1BD20 022-1BD50	022-1BD70 022-1BF00 022-1BF50 022-1HB10	022-1DF00 022-1SD00		
--	--	--	------------------------	--	--

Order number	022-1BD70	022-1BF00	022-1BF50	022-1HB10
Figure				
Type	SM 022	SM 022	SM 022	SM 022
Module ID	0F43 57E2	0106 AFC8	0107 AFC8	0109 AF90
General information				
Note	-	-	-	-
Features	<ul style="list-style-type: none"> ▸ 4 outputs ▸ Time stamp ▸ Output current 0.5 A 	<ul style="list-style-type: none"> ▸ 8 outputs ▸ Output current 0.5 A 	<ul style="list-style-type: none"> ▸ 8 Low-Side outputs ▸ Output current 0.5 A 	<ul style="list-style-type: none"> ▸ 2 relay outputs ▸ DC 30 V/ AC 230 V ▸ Output current 3 A
Current consumption/power loss				
Current consumption from backplane bus	90 mA	65 mA	70 mA	130 mA
Power loss	0.95 W	0.7 W	0.6 W	0.7 W
Technical data digital outputs				
Number of outputs	4	8	8	2
Cable length, shielded	1000 m	1000 m	1000 m	-
Cable length, unshielded	600 m	600 m	600 m	-
Rated load voltage	DC 20.4...28.8 V	DC 20.4...28.8 V	DC 20.4...28.8 V	DC 30 V/ AC 230 V
Current consumption from load voltage L+ (without load)	25 mA	15 mA	10 mA	-
Total current per group, horizontal configuration, 40°C	2 A	4 A	2.5 A	-
Total current per group, horizontal configuration, 60°C	2 A	4 A	2.5 A	-
Total current per group, vertical configuration	2 A	4 A	2.5 A	-
Output current at signal "1", rated value	0.5 A	0.5 A	0.5 A	3 A
Output delay of "0" to "1"	max. 100 ns	30 µs	30 µs	6 ms
Output delay of "1" to "0"	max. 100 ns	175 µs	100 µs	3 ms
Minimum load current	-	-	-	-
Lamp load	10 W	10 W	10 W	-
Parallel switching of outputs for redundant control of a load	not possible	not possible	not possible	-
Parallel switching of outputs for increased power	not possible	not possible	not possible	-
Actuation of digital input	✓	✓	✓	-
Switching frequency with resistive load	max. 40 kHz	max. 1000 Hz	max. 1000 Hz	max. 100 Hz
Switching frequency with inductive load	max. 40 kHz	max. 0.5 Hz	max. 0.5 Hz	-
Switching frequency on lamp load	max. 40 kHz	max. 10 Hz	max. 10 Hz	-
Internal limitation of inductive shut-off voltage	L+ (-52 V)	L+ (-45 V)	+45 V	-
Short-circuit protection of output	yes, electronic, and only highside	yes, electronic	yes, electronic	-
Trigger level	2.5 A	1 A	1.7 A	-
Number of operating cycle of relay outputs	-	-	-	-

Signal modules digital | Digital output modules

022-1BB00	022-1BB90	022-1BD70	022-1DF00			
022-1BB20	022-1BD00	022-1BF00	022-1SD00			
022-1BB50	022-1BD20	022-1BF50				
022-1BB70	022-1BD50	022-1HB10				

Order number	022-1BD70	022-1BF00	022-1BF50	022-1HB10
Switching capacity of contacts	-	-	-	3 A
Output data size	60 Byte	8 Bit	8 Bit	2 Bit
Status information, alarms, diagnostics				
Status display	green LED per channel	green LED per channel	red LED per channel	red LED per channel
Interrupts	no	no	no	no
Process alarm	no	no	no	no
Diagnostic interrupt	no	no	no	no
Diagnostic functions	no	no	no	no
Diagnostics information read-out	possible	none	none	none
Supply voltage display	green LED	green LED	green LED	green LED
Group error display	red SF LED	red SF LED	red LED	red LED
Channel error display	none	none	none	none
Isolation				
Between channels	-	-	-	✓
Between channels of groups to	-	-	-	-
Between channels and backplane bus	✓	✓	✓	✓
Insulation tested with	DC 500 V	DC 500 V	DC 500 V	DC 500 V
PWM data				
PWM channels	-	-	-	-
PWM time basis	-	-	-	-
Period length	-	-	-	-
Minimum pulse width	-	-	-	-
PtP communication	-	-	-	-
Safety				
Safety protocol	-	-	-	-
Safety requirements	-	-	-	-
Secure user address	-	-	-	-
Watchdog	-	-	-	-
Two channels	-	-	-	-
Test pulse length	-	-	-	-
Circuit monitoring	-	-	-	-
Datasizes				
Input bytes	4	0	0	0
Output bytes	20 / 60	1	1	1
Parameter bytes	6	0	0	0
Diagnostic bytes	20	0	0	0

Signal modules digital Digital output modules						
022-1BB00	022-1BB90	022-1BD70	022-1DF00			
022-1BB20	022-1BD00	022-1BF00	022-1SD00			
022-1BB50	022-1BD20	022-1BF50				
022-1BB70	022-1BD50	022-1HB10				

Order number	022-1BD70	022-1BF00	022-1BF50	022-1HB10
Housing				
Material	PPE / PPE GF10	PPE / PPE GF10	PPE / PPE GF10	PPE / PPE GF10
Mounting	Profile rail 35 mm	Profile rail 35 mm	Profile rail 35 mm	Profile rail 35 mm
Mechanical data				
Dimensions (WxHxD)	12.9 mm x 109 mm x 76.5 mm	12.9 mm x 109 mm x 76.5 mm	12.9 mm x 109 mm x 76.5 mm	12.9 mm x 109 mm x 76.5 mm
Weight	60 g	60 g	60 g	60 g
Environmental conditions				
Operating temperature	0 °C to 60 °C	0 °C to 60 °C	0 °C to 60 °C	0 °C to 60 °C
Storage temperature	-25 °C to 70 °C	-25 °C to 70 °C	-25 °C to 70 °C	-25 °C to 70 °C
Certifications				
UL508 certification	yes	yes	yes	yes

Connections, Interfaces

Signal modules digital Digital output modules					
022-1BB00	022-1BB90	022-1BD70	022-1DF00		
022-1BB20	022-1BD00	022-1BF00	022-1SD00		
022-1BB50	022-1BD20	022-1BF50			
022-1BB70	022-1BD50	022-1HB10			

022-1BD70

022-1BF00



022-1BF50

022-1HB10

Digital output modules

Signal modules digital | Digital output modules

022-1BB00 022-1BB20 022-1BB50 022-1BB70	022-1BB90 022-1BD00 022-1BD20 022-1BD50	022-1BD70 022-1BF00 022-1BF50 022-1HB10	022-1DF00 022-1SD00			
--	--	--	------------------------	--	--	--

Order number	022-1DF00	022-1SD00		
Figure				
Type	SM 022	SM 022		
Module ID	0113 2F48	0C81 1E00		
General information				
Note	-	-		
Features	<ul style="list-style-type: none"> ▸ 8 outputs ▸ Output current 0.5 A ▸ diagnosis of wiring errors 	<ul style="list-style-type: none"> ▸ 4 outputs ▸ Safety ▸ Output current 0.5 A 		
Current consumption/power loss				
Current consumption from backplane bus	65 mA	75 mA		
Power loss	1 W	1 W		
Technical data digital outputs				
Number of outputs	8	4		
Cable length, shielded	1000 m	1000 m		
Cable length, unshielded	600 m	600 m		
Rated load voltage	DC 20.4...28.8 V	DC 20.4...28.8 V		
Current consumption from load voltage L+ (without load)	11 mA	15 mA		
Total current per group, horizontal configuration, 40°C	4 A	2 A		
Total current per group, horizontal configuration, 60°C	4 A	-		
Total current per group, vertical configuration	4 A	-		
Output current at signal "1", rated value	0.5 A	0.5 A		
Output delay of "0" to "1"	max. 350 µs	100 µs		
Output delay of "1" to "0"	max. 350 µs	175 µs		
Minimum load current	-	-		
Lamp load	10 W	5 W		
Parallel switching of outputs for redundant control of a load	not possible	not possible		
Parallel switching of outputs for increased power	not possible	not possible		
Actuation of digital input	✓	✓		
Switching frequency with resistive load	max. 1000 Hz	max. 50 Hz		
Switching frequency with inductive load	max. 0.5 Hz	max. 0.5 Hz		
Switching frequency on lamp load	max. 10 Hz	max. 10 Hz		
Internal limitation of inductive shut-off voltage	L+ (-52 V)	L+ (-45 V)		
Short-circuit protection of output	yes, electronic	yes, electronic		
Trigger level	1 A	1.7 A		
Number of operating cycle of relay outputs	-	-		

Signal modules digital | Digital output modules

022-1BB00	022-1BB90	022-1BD70	022-1DF00			
022-1BB20	022-1BD00	022-1BF00	022-1SD00			
022-1BB50	022-1BD20	022-1BF50				
022-1BB70	022-1BD50	022-1HB10				

Order number	022-1DF00	022-1SD00		
Switching capacity of contacts	-	-		
Output data size	8 Bit	4 Bit		
Status information, alarms, diagnostics				
Status display	green LED per channel	green LED per channel		
Interrupts	yes, parameterizable	yes, parameterizable		
Process alarm	no	no		
Diagnostic interrupt	yes, parameterizable	yes, parameterizable		
Diagnostic functions	yes	yes, parameterizable		
Diagnostics information read-out	possible	possible		
Supply voltage display	green LED	green LED		
Group error display	red SF LED	red SF LED		
Channel error display	none	red ERR-LED and yellow ER2-LED		
Isolation				
Between channels	-	-		
Between channels of groups to	-	-		
Between channels and backplane bus	✓	✓		
Insulation tested with	DC 500 V	DC 500 V		
PWM data				
PWM channels	-	-		
PWM time basis	-	-		
Period length	-	-		
Minimum pulse width	-	-		
PtP communication	-	-		
Safety				
Safety protocol	-	PROFIsafe V2		
Safety requirements	-	SIL CL 3, PL e, Kat 4		
Secure user address	-	1 - 4095		
Watchdog	-	parameterizable 10ms - 1s		
Two channels	-	Each 2 of 4 outputs switchable		
Test pulse length	-	parameterizable 500µs - 10ms		
Circuit monitoring	-	✓		
Datasizes				
Input bytes	0	5		
Output bytes	1	5		
Parameter bytes	7	44		
Diagnostic bytes	20	20		

Signal modules digital | Digital output modules

022-1BB00	022-1BB90	022-1BD70	022-1DF00			
022-1BB20	022-1BD00	022-1BF00	022-1SD00			
022-1BB50	022-1BD20	022-1BF50				
022-1BB70	022-1BD50	022-1HB10				

Order number	022-1DF00	022-1SD00		
Housing				
Material	PPE / PPE GF10	PC / PPE GF10		
Mounting	Profile rail 35 mm	Profile rail 35 mm		
Mechanical data				
Dimensions (WxHxD)	12.9 mm x 109 mm x 76.5 mm	12.9 mm x 109 mm x 76.5 mm		
Weight	60 g	60 g		
Environmental conditions				
Operating temperature	0 °C to 60 °C	0 °C to 60 °C		
Storage temperature	-25 °C to 70 °C	-25 °C to 70 °C		
Certifications				
UL508 certification	in preparation	in preparation		

Connections, Interfaces

Signal modules digital Digital output modules			
022-1BB00	022-1BB90	022-1BD70	022-1DF00
022-1BB20	022-1BD00	022-1BF00	022-1SD00
022-1BB50	022-1BD20	022-1BF50	
022-1BB70	022-1BD50	022-1HB10	

022-1DF00

Technical drawing of the 022-1DF00 module showing front, side, and rear views with dimensions: 76.5, 104, 109, 12.9, 15, 133. It also includes a terminal block diagram with 8 channels and DC24V/0V connections.

022-1SD00

Technical drawing of the 022-1SD00 module showing front, side, and rear views with dimensions: 76.5, 104, 109, 12.9, 15, 133. It also includes a terminal block diagram with 8 channels and DC24V/0V connections.

Signal modules analog



Structure and Function

Signal modules (SM) to connect sensors and actuators are the interfaces of the system to the process. Analog signal modules acquire the analog control signals (e.g. measurement data) to and out of the process level. Depending on the application and type the control signals are acquired from the process level and converted into interpretable signals for controlling. Analog output modules convert the internal control signals into signals suitable for the process level.

A variety of different analog signal modules accurately provide the inputs and outputs that are required for each task. The analog modules differ in the number of channels, voltage and current ranges, isolation, and diagnostic and alarm capability.

Each signal module consists of a terminal and an electronics module.

The terminal module (TM) contains the retainer for the electronic module (EM), the backplane connectors and contacts for the distribution of the load power supply electronics, the modular connection to DC 24 V load power supply and the staircase-shaped terminal block for the wiring.

Furthermore the terminal module processes a locking system for fixing to a profile rail. The SLIO system can also be constructed "block by block" outside the cabinet and later assembled as a complete system in the control cabinet.

The functionality of the signal module is defined via the electronics module that is connected by a secure sliding mechanism to the terminal module.

During service the defective electronic module can be replaced without detaching the wiring.

Characteristics

- › 2 or 4 channel
- › 12 bit or 16 bit resolution
- › Functions of the inputs / outputs programmable
- › Most various assemblies, suitable for measuring transducers (current/ voltage, resistance or temperature sensors)
- › Direct mapping and readability of the channel conditions via status LEDs
- › Safe and time-saving installation by the terminal assignment mounted on the module
- › When changing the module equipment identification (BMK) is retained on the TM
- › Individual single-channel lettering on insertion strip
- › 24 month warranty



Overview

Order no.	Name/Description	Page
Analog input modules		
031-1BB10	SM 031 - Analog input ▶ 2 inputs 12Bit ▶ Current 4...20 mA ▶ 2 wire	77
031-1BB30	SM 031 - Analog input ▶ 2 inputs 12Bit ▶ Voltage 0...10 V	77
031-1BB40	SM 031 - Analog input ▶ 2 inputs 12Bit ▶ Current 0(4)...20 mA	77
031-1BB60	SM 031 - Analog input ▶ 2 inputs 12Bit ▶ Current 4...20 mA ▶ 2 wire	77
031-1BB70	SM 031 - Analog input ▶ 2 inputs 12Bit ▶ Voltage -10 V...+10 V	81
031-1BB90	SM 031 - Analog input ▶ 2 inputs 16Bit ▶ Thermocouple ▶ Voltage -80mV...+80mV	81
031-1BD30	SM 031 - Analog input ▶ 4 inputs 12Bit ▶ Voltage 0...10 V	81
031-1BD40	SM 031 - Analog input ▶ 4 inputs 12Bit ▶ Current 0(4)...20 mA	81
031-1BD70	SM 031 - Analog input ▶ 4 inputs 12Bit ▶ Voltage -10 V...+10 V	85
031-1BD80	SM 031 - Analog input ▶ 4 inputs 16Bit ▶ 0 .. 3000 ohm resistance ▶ Resistance measurment with 2, 3, and 4-wires	85
031-1CB30	SM 031 - Analog input ▶ 2 inputs 16Bit ▶ Voltage 0...10 V	85
031-1CB40	SM 031 - Analog input ▶ 2 inputs 16Bit ▶ Current 0(4)...20 mA	85
031-1CB70	SM 031 - Analog input ▶ 2 inputs 16Bit ▶ Voltage -10 V...+10 V	89
031-1CD30	SM 031 - Analog input ▶ 4 inputs 16Bit ▶ Voltage 0...10 V	89
031-1CD35	SM 031 - Analog input ▶ 4 inputs 16Bit ▶ Voltage 0...10 V	89
031-1CD40	SM 031 - Analog input ▶ 4 inputs 16Bit ▶ Current 0(4)...20 mA	89
031-1CD45	SM 031 - Analog input ▶ 4 inputs 16Bit ▶ Current 0(4)...20 mA	93
031-1CD70	SM 031 - Analog input ▶ 4 inputs 16Bit ▶ Voltage -10 V...+10 V	93
031-1LB90	SM 031 - Analog input ▶ 2 inputs 16Bit ▶ Thermocouple ▶ Voltage -80mV...+80mV ▶ requires less parameter bytes than module 031-1BB90	93
031-1LD80	SM 031 - Analog input ▶ 4 inputs 16Bit ▶ 0 .. 3000 ohm resistance ▶ Resistance measurment with 2, 3, and 4-wires ▶ requires less parameter bytes than module 031-1BD80	93

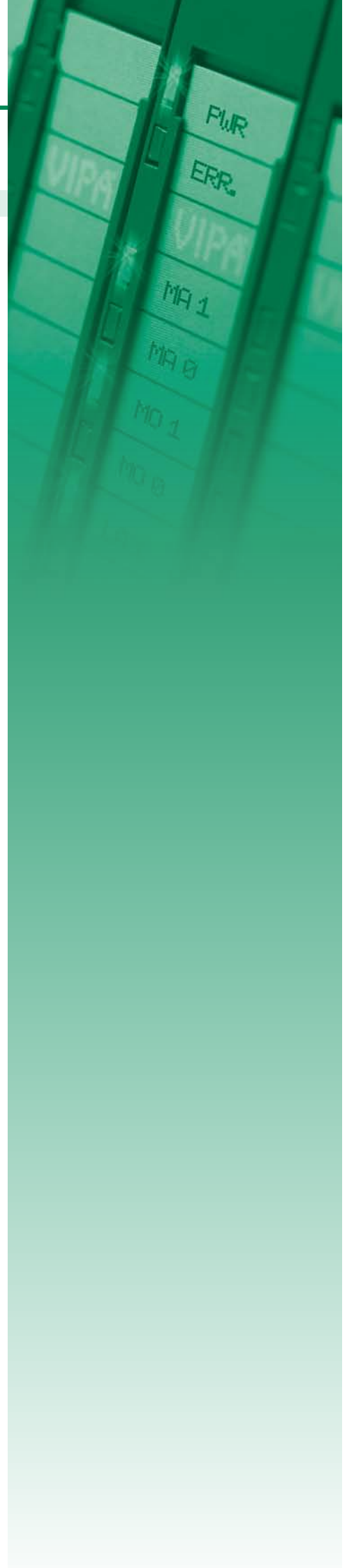



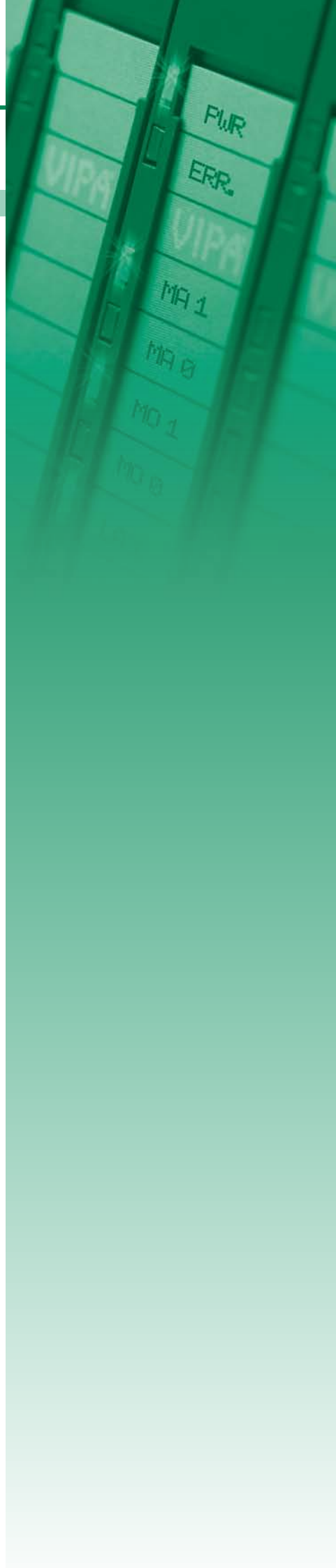

Overview

Order no.	Name/Description	Page
Analog output modules		
032-1BB30	SM 032 - Analog output ▶ 2 outputs 12Bit ▶ Voltage 0...10 V	98
032-1BB40	SM 032 - Analog output ▶ 2 outputs 12Bit ▶ Current 0(4)...20 mA	98
032-1BB70	SM 032 - Analog output ▶ 2 outputs 12Bit ▶ Voltage -10 V...+10 V	98
032-1BD30	SM 032 - Analog output ▶ 4 outputs 12Bit ▶ Voltage 0...10 V	98
032-1BD40	SM 032 - Analog output ▶ 4 outputs 12Bit ▶ Current 0(4)...20mA	101
032-1BD70	SM 032 - Analog output ▶ 4 outputs 12Bit ▶ Voltage -10 V...+10 V	101
032-1CB30	SM 032 - Analog output ▶ 2 outputs 16Bit ▶ Voltage 0...10 V	101
032-1CB70	SM 032 - Analog output ▶ 2 outputs 16Bit ▶ Voltage -10 V...+10 V	101
032-1CD30	SM 032 - Analog output ▶ 4 outputs 16Bit ▶ Voltage 0...10 V	104
032-1CD70	SM 032 - Analog output ▶ 4 outputs 16Bit ▶ Voltage -10 V...+10 V	104



Analog input modules

Signal modules analog Analog input modules						
031-1BB10	031-1BB70	031-1BD70	031-1CB70	031-1CD45		
031-1BB30	031-1BB90	031-1BD80	031-1CD30	031-1CD70		
031-1BB40	031-1BD30	031-1CB30	031-1CD35	031-1LB90		
031-1BB60	031-1BD40	031-1CB40	031-1CD40	031-1LD80		

Order number	031-1BB10	031-1BB30	031-1BB40	031-1BB60
Figure				
Type	SM 031	SM 031	SM 031	SM 031
Module ID	0411 1543	0401 15C3	0402 15C3	0407 15C3
General information				
Note	-	-	-	-
Features	<ul style="list-style-type: none"> ▶ 2 inputs 12Bit ▶ Current 4...20 mA ▶ 2 wire 	<ul style="list-style-type: none"> ▶ 2 inputs 12Bit ▶ Voltage 0...10 V 	<ul style="list-style-type: none"> ▶ 2 inputs 12Bit ▶ Current 0(4)...20 mA 	<ul style="list-style-type: none"> ▶ 2 inputs 12Bit ▶ Current 4...20 mA ▶ 2 wire
Current consumption/power loss				
Current consumption from backplane bus	50 mA	70 mA	70 mA	50 mA
Power loss	0.7 W	0.7 W	0.7 W	0.7 W
Technical data analog inputs				
Number of inputs	2	2	2	2
Cable length, shielded	200 m	200 m	200 m	200 m
Rated load voltage	DC 24 V	DC 24 V	DC 24 V	DC 24 V
Current consumption from load voltage L+ (without load)	20 mA	15 mA	15 mA	15 mA
Voltage inputs	-	✓	-	-
Min. input resistance (voltage range)	-	100 kΩ	-	-
Input voltage ranges	-	0 V ... +10 V	-	-
Operational limit of voltage ranges	-	+/-0.3%	-	-
Operational limit of voltage ranges with SFU	-	-	-	-
Basic error limit voltage ranges	-	+/-0.2%	-	-
Basic error limit voltage ranges with SFU	-	-	-	-
Destruction limit current	-	-	-	-
Current inputs	✓	-	✓	✓
Max. input resistance (current range)	60 Ω	-	110 Ω	110 Ω
Input current ranges	+4 mA ... +20 mA 0 mA ... +20 mA	-	0 mA ... +20 mA +4 mA ... +20 mA	0 mA ... +20 mA +4 mA ... +20 mA
Operational limit of current ranges	+/-0.5%	-	+/-0.3% ... +/-0.5%	+/-0.5%
Operational limit of current ranges with SFU	-	-	-	-
Basic error limit current ranges	+/-0.3%	-	+/-0.2% ... +/-0.3%	+/-0.3%
Radical error limit current ranges with SFU	-	-	-	-
Destruction limit current inputs (voltage)	-	-	-	-
Destruction limit current inputs (electrical current)	-	-	-	-
Resistance inputs	-	-	-	-
Resistance ranges	-	-	-	-
Operational limit of resistor ranges	-	-	-	-
Operational limit of resistor ranges with SFU	-	-	-	-

Signal modules analog | Analog input modules

031-1BB10	031-1BB70	031-1BD70	031-1CB70	031-1CD45		
031-1BB30	031-1BB90	031-1BD80	031-1CD30	031-1CD70		
031-1BB40	031-1BD30	031-1CB30	031-1CD35	031-1LB90		
031-1BB60	031-1BD40	031-1CB40	031-1CD40	031-1LD80		

Order number	031-1BB10	031-1BB30	031-1BB40	031-1BB60
Basic error limit	-	-	-	-
Basic error limit with SFU	-	-	-	-
Destruction limit resistance inputs	-	-	-	-
Resistance thermometer inputs	-	-	-	-
Resistance thermometer ranges	-	-	-	-
Operational limit of resistance thermometer ranges	-	-	-	-
Operational limit of resistance thermometer ranges with SFU	-	-	-	-
Basic error limit thermoresistor ranges	-	-	-	-
Operational limit of resistance thermometer ranges with SFU	-	-	-	-
Destruction limit resistance thermometer inputs	-	-	-	-
Thermocouple inputs	-	-	-	-
Thermocouple ranges	-	-	-	-
Operational limit of thermocouple ranges	-	-	-	-
Operational limit of thermocouple ranges with SFU	-	-	-	-
Basic error limit thermoelement ranges	-	-	-	-
Basic error limit thermoelement ranges with SFU	-	-	-	-
Destruction limit thermocouple inputs	-	-	-	-
Programmable temperature compensation	-	-	-	-
External temperature compensation	-	-	-	-
Internal temperature compensation	-	-	-	-
Internal temperature compensation	-	-	-	-
Technical unit of temperature measurement	-	-	-	-
Resolution in bit	12	12	12	12
Measurement principle	successive approximation	successive approximation	successive approximation	successive approximation
Basic conversion time	1.15 ms all channels	2 ms all channels	2 ms all channels	2 ms all channels
Noise suppression for frequency	>80dB (UCM<20V)	>50dB at 50Hz (UCM<2V)	>50dB at 50Hz (UCM<2V)	>50dB at 50Hz (UCM<2V)
Status information, alarms, diagnostics				
Status display	yes	yes	yes	yes
Interrupts	yes, parameterizable	no	no	no
Process alarm	yes, parameterizable	no	no	no
Diagnostic interrupt	yes, parameterizable	no	no	no
Diagnostic functions	yes	yes	yes	yes
Diagnostics information read-out	possible	possible	possible	possible
Module state	green LED	green LED	green LED	green LED
Module error display	red LED	red LED	red LED	red LED
Channel error display	red LED per channel	red LED per channel	red LED per channel	red LED per channel

Signal modules analog | Analog input modules

031-1BB10	031-1BB70	031-1BD70	031-1CB70	031-1CD45		
031-1BB30	031-1BB90	031-1BD80	031-1CD30	031-1CD70		
031-1BB40	031-1BD30	031-1CB30	031-1CD35	031-1LB90		
031-1BB60	031-1BD40	031-1CB40	031-1CD40	031-1LD80		

Order number	031-1BB10	031-1BB30	031-1BB40	031-1BB60
Isolation				
Between channels	✓	-	-	-
Between channels of groups to	1	-	-	-
Between channels and backplane bus	✓	✓	✓	✓
Between channels and power supply	✓	✓	✓	-
Max. potential difference between circuits	DC 75 V/ AC 60 V	-	-	-
Max. potential difference between inputs (Ucm)	DC 75 V/ AC 60 V	DC 2 V	DC 2 V	-
Max. potential difference between Mana and Mintern (Uiso)	-	-	-	-
Max. potential difference between inputs and Mana (Ucm)	DC 75 V/ AC 60 V	-	-	-
Max. potential difference between inputs and Mintern (Uiso)	DC 75 V/ AC 60 V	DC 75 V/ AC 60 V	DC 75 V/ AC 60 V	DC 75 V/ AC 60 V
Max. potential difference between Mintern and outputs	-	-	-	-
Insulation tested with	DC 500 V	DC 500 V	DC 500 V	DC 500 V
Datasizes				
Input bytes	4	4	4	4
Output bytes	0	0	0	0
Parameter bytes	20	6	6	6
Diagnostic bytes	20	20	20	20
Housing				
Material	PPE / PPE GF10	PPE / PPE GF10	PPE / PPE GF10	PPE / PPE GF10
Mounting	Profile rail 35 mm	Profile rail 35 mm	Profile rail 35 mm	Profile rail 35 mm
Mechanical data				
Dimensions (WxHxD)	12.9 mm x 109 mm x 76.5 mm	12.9 mm x 109 mm x 76.5 mm	12.9 mm x 109 mm x 76.5 mm	12.9 mm x 109 mm x 76.5 mm
Weight	60 g	60 g	60 g	60 g
Environmental conditions				
Operating temperature	0 °C to 60 °C	0 °C to 60 °C	0 °C to 60 °C	0 °C to 60 °C
Storage temperature	-25 °C to 70 °C	-25 °C to 70 °C	-25 °C to 70 °C	-25 °C to 70 °C
Certifications				
UL508 certification	yes	yes	yes	yes

Connections, Interfaces

Signal modules analog | Analog input modules

031-1BB10	031-1BB70	031-1BD70	031-1CB70	031-1CD45		
031-1BB30	031-1BB90	031-1BD80	031-1CD30	031-1CD70		
031-1BB40	031-1BD30	031-1CB30	031-1CD35	031-1LB90		
031-1BB60	031-1BD40	031-1CB40	031-1CD40	031-1LD80		

031-1BB10

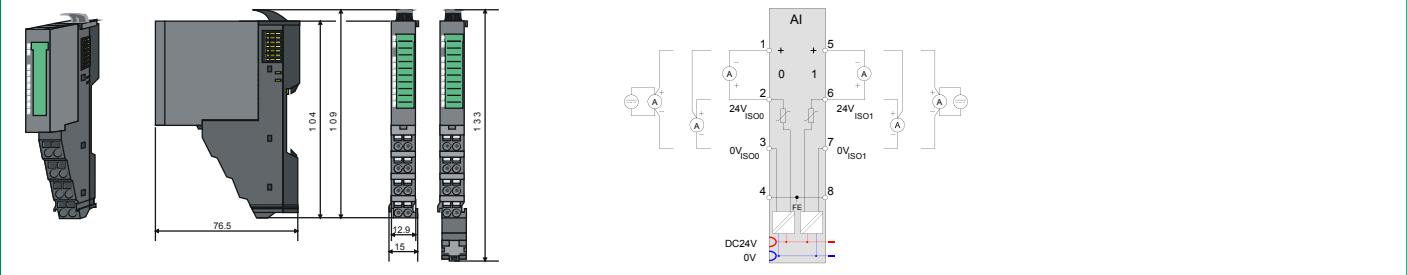

031-1BB30

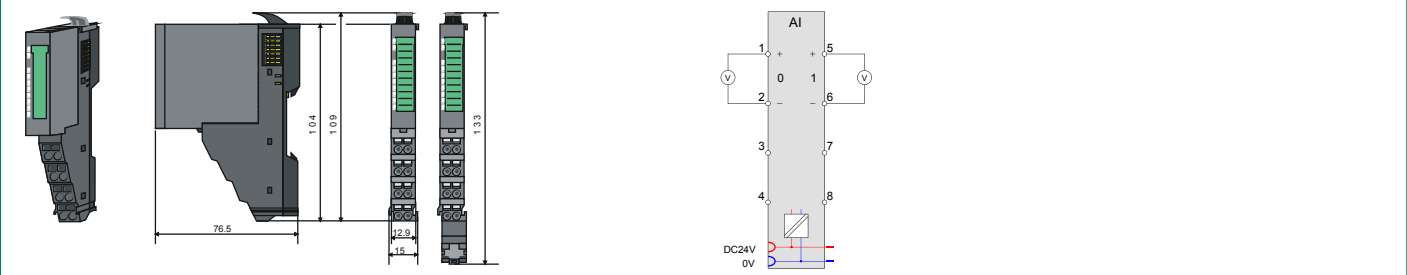

031-1BB40

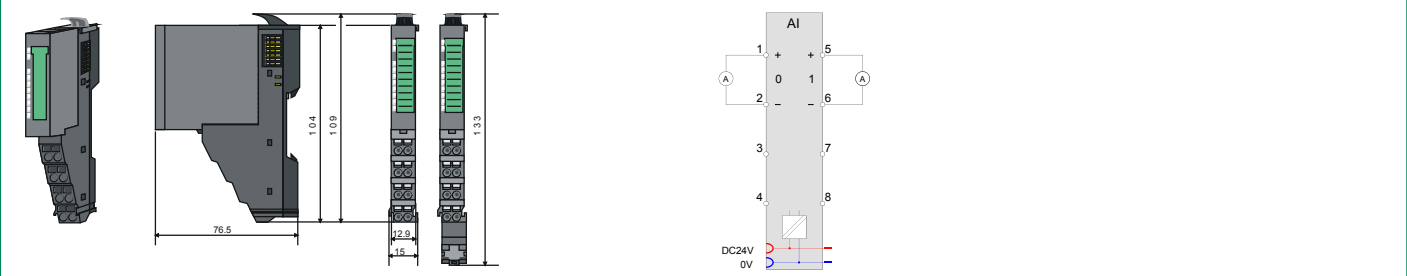



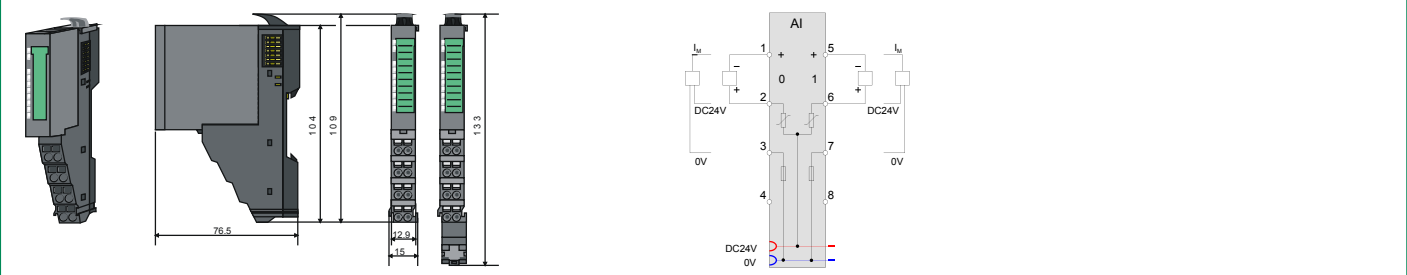

031-1BB60



Analog input modules

Signal modules analog | Analog input modules

031-1BB10	031-1BB70	031-1BD70	031-1CB70	031-1CD45		
031-1BB30	031-1BB90	031-1BD80	031-1CD30	031-1CD70		
031-1BB40	031-1BD30	031-1CB30	031-1CD35	031-1LB90		
031-1BB60	031-1BD40	031-1CB40	031-1CD40	031-1LD80		

Order number	031-1BB70	031-1BB90	031-1BD30	031-1BD40
Figure				
Type	SM 031	SM 031	SM 031	SM 031
Module ID	0408 15C3	0403 1543	0404 15C4	0405 15C4
General information				
Note	-	-	-	-
Features	<ul style="list-style-type: none"> ▸ 2 inputs 12Bit ▸ Voltage -10 V...+10 V 	<ul style="list-style-type: none"> ▸ 2 inputs 16Bit ▸ Thermocouple ▸ Voltage -80mV...+80mV 	<ul style="list-style-type: none"> ▸ 4 inputs 12Bit ▸ Voltage 0...+10 V 	<ul style="list-style-type: none"> ▸ 4 inputs 12Bit ▸ Current 0(4)...20 mA
Current consumption/power loss				
Current consumption from backplane bus	50 mA	75 mA	70 mA	70 mA
Power loss	0.5 W	1.1 W	0.7 W	0.7 W
Technical data analog inputs				
Number of inputs	2	2	4	4
Cable length, shielded	200 m	200 m	200 m	200 m
Rated load voltage	DC 24 V	DC 24 V	DC 24 V	DC 24 V
Current consumption from load voltage L+ (without load)	15 mA	30 mA	15 mA	15 mA
Voltage inputs	✓	-	✓	-
Min. input resistance (voltage range)	100 kΩ	10 MΩ	100 kΩ	-
Input voltage ranges	-10 V ... +10 V	-80 mV ... +80 mV	0 V ... +10 V	-
Operational limit of voltage ranges	+/-0.3%	±0.3%	+/-0.3%	-
Operational limit of voltage ranges with SFU	-	±0.1%	-	-
Basic error limit voltage ranges	+/-0.2%	±0.25%	+/-0.2%	-
Basic error limit voltage ranges with SFU	-	±0.05%	-	-
Destruction limit current	-	-	-	-
Current inputs	-	-	-	✓
Max. input resistance (current range)	-	-	-	110 Ω
Input current ranges	-	-	-	0 mA ... +20 mA +4 mA ... +20 mA
Operational limit of current ranges	-	-	-	+/-0.3% ... +/-0.5%
Operational limit of current ranges with SFU	-	-	-	-
Basic error limit current ranges	-	-	-	+/-0.2% ... +/-0.3%
Radical error limit current ranges with SFU	-	-	-	-
Destruction limit current inputs (voltage)	-	-	-	-
Destruction limit current inputs (electrical current)	-	-	-	-
Resistance inputs	-	-	-	-
Resistance ranges	-	-	-	-
Operational limit of resistor ranges	-	-	-	-
Operational limit of resistor ranges with SFU	-	-	-	-

Signal modules analog | Analog input modules

031-1BB10	031-1BB70	031-1BD70	031-1CB70	031-1CD45		
031-1BB30	031-1BB90	031-1BD80	031-1CD30	031-1CD70		
031-1BB40	031-1BD30	031-1CB30	031-1CD35	031-1LB90		
031-1BB60	031-1BD40	031-1CB40	031-1CD40	031-1LD80		

Order number	031-1BB70	031-1BB90	031-1BD30	031-1BD40
Basic error limit	-	-	-	-
Basic error limit with SFU	-	-	-	-
Destruction limit resistance inputs	-	-	-	-
Resistance thermometer inputs	-	-	-	-
Resistance thermometer ranges	-	-	-	-
Operational limit of resistance thermometer ranges	-	-	-	-
Operational limit of resistance thermometer ranges with SFU	-	-	-	-
Basic error limit thermoresistor ranges	-	-	-	-
Operational limit of resistance thermometer ranges with SFU	-	-	-	-
Destruction limit resistance thermometer inputs	-	-	-	-
Thermocouple inputs	-	✓	-	-
Thermocouple ranges	-	type B type C type E type J type K type L type N type R type S type T	-	-
Operational limit of thermocouple ranges	-	Type E, L, T, J, K, N: ±2.5K / Type B, C, R, S: ±8.0K	-	-
Operational limit of thermocouple ranges with SFU	-	Type E, L, T, J, K, N: ±1.5K / Type B, C, R, S: ±4.0K	-	-
Basic error limit thermoelement ranges	-	Type E, L, T, J, K, N: ±2.0K / Type B, C, R, S: ±7.0K	-	-
Basic error limit thermoelement ranges with SFU	-	Type E, L, T, J, K, N: ±1.0K / Type B, C, R, S: ±3.0K	-	-
Destruction limit thermocouple inputs	-	-	-	-
Programmable temperature compensation	-	✓	-	-
External temperature compensation	-	✓	-	-
Internal temperature compensation	-	✓	-	-
Internal temperature compensation	-	1 K	-	-
Technical unit of temperature measurement	-	-	-	-
Resolution in bit	12	16	12	12
Measurement principle	successive approximation	Sigma-Delta	successive approximation	successive approximation
Basic conversion time	2 ms all channels	4.2...324.1 ms (50 Hz) 3.8...270.5 ms (60 Hz) per channel	4 ms all channels	4 ms all channels
Noise suppression for frequency	>50dB at 50Hz (UCM<2V)	>90dB at 50Hz (UCM<10V)	>50dB at 50Hz (UCM<2V)	>50dB at 50Hz (UCM<2V)

Signal modules analog Analog input modules						
031-1BB10	031-1BB70	031-1BD70	031-1CB70	031-1CD45		
031-1BB30	031-1BB90	031-1BD80	031-1CD30	031-1CD70		
031-1BB40	031-1BD30	031-1CB30	031-1CD35	031-1LB90		
031-1BB60	031-1BD40	031-1CB40	031-1CD40	031-1LD80		

Order number	031-1BB70	031-1BB90	031-1BD30	031-1BD40
Status information, alarms, diagnostics				
Status display	yes	yes	yes	yes
Interrupts	no	yes	no	no
Process alarm	no	yes, parameterizable	no	no
Diagnostic interrupt	no	yes, parameterizable	no	no
Diagnostic functions	yes	yes	yes	yes
Diagnostics information read-out	possible	possible	possible	possible
Module state	green LED	green LED	green LED	green LED
Module error display	red LED	red LED	red LED	red LED
Channel error display	red LED per channel	red LED per channel	red LED per channel	red LED per channel
Isolation				
Between channels	-	-	-	-
Between channels of groups to	-	-	-	-
Between channels and backplane bus	✓	✓	✓	✓
Between channels and power supply	✓	-	✓	✓
Max. potential difference between circuits	-	-	-	-
Max. potential difference between inputs (Ucm)	DC 2 V	DC 140 V/ AC 60 V	DC 2 V	DC 2 V
Max. potential difference between Mana and Mintern (Uiso)	-	-	-	-
Max. potential difference between inputs and Mana (Ucm)	-	-	-	-
Max. potential difference between inputs and Mintern (Uiso)	DC 75 V/ AC 60 V	DC 75 V/ AC 60 V	DC 75 V/ AC 60 V	DC 75 V/ AC 60 V
Max. potential difference between Mintern and outputs	-	-	-	-
Insulation tested with	DC 500 V	DC 500 V	DC 500 V	DC 500 V
Datasizes				
Input bytes	4	4	8	8
Output bytes	0	0	0	0
Parameter bytes	6	22	8	8
Diagnostic bytes	20	20	20	20
Housing				
Material	PPE / PPE GF10	PPE / PPE GF10	PPE / PPE GF10	PPE / PPE GF10
Mounting	Profile rail 35 mm	Profile rail 35 mm	Profile rail 35 mm	Profile rail 35 mm
Mechanical data				
Dimensions (WxHxD)	12.9 mm x 109 mm x 76.5 mm	12.9 mm x 109 mm x 76.5 mm	12.9 mm x 109 mm x 76.5 mm	12.9 mm x 109 mm x 76.5 mm
Weight	60 g	60 g	60 g	60 g
Environmental conditions				
Operating temperature	0 °C to 60 °C	0 °C to 60 °C	0 °C to 60 °C	0 °C to 60 °C
Storage temperature	-25 °C to 70 °C	-25 °C to 70 °C	-25 °C to 70 °C	-25 °C to 70 °C
Certifications				
UL508 certification	yes	yes	yes	yes

Connections, Interfaces

Signal modules analog | Analog input modules

031-1BB10	031-1BB70	031-1BD70	031-1CB70	031-1CD45		
031-1BB30	031-1BB90	031-1BD80	031-1CD30	031-1CD70		
031-1BB40	031-1BD30	031-1CB30	031-1CD35	031-1LB90		
031-1BB60	031-1BD40	031-1CB40	031-1CD40	031-1LD80		

031-1BB70

Technical drawing of the 031-1BB70 module. It includes a perspective view, a front view with dimensions (76.5, 10.4, 10.9, 12.9, 15, 13.3), and a terminal block diagram. The terminal block diagram shows 8 terminals labeled 1 through 8. Terminals 1, 5, 6, and 7 are marked with a voltage symbol (V). Terminals 2 and 3 are marked with a plus sign (+). Terminal 4 is marked with a minus sign (-). Terminals 8 and 9 are marked with a square symbol. A DC24V supply is connected to terminals 8 and 9, and a 0V supply is connected to terminal 9.

031-1BB90

Technical drawing of the 031-1BB90 module. It includes a perspective view, a front view with dimensions (76.5, 10.4, 10.9, 12.9, 15, 13.3), and a terminal block diagram. The terminal block diagram shows 8 terminals labeled 1 through 8. Terminals 1, 5, 6, and 7 are marked with a voltage symbol (V). Terminals 2 and 3 are marked with a plus sign (+). Terminal 4 is marked with a minus sign (-). Terminals 8 and 9 are marked with a square symbol. A DC24V supply is connected to terminals 8 and 9, and a 0V supply is connected to terminal 9.

031-1BD30





Technical drawing of the 031-1BD30 module. It includes a perspective view, a front view with dimensions (76.5, 10.4, 10.9, 12.9, 15, 13.3), and a terminal block diagram. The terminal block diagram shows 8 terminals labeled 1 through 8. Terminals 1, 5, 6, and 7 are marked with an ammeter symbol (A). Terminals 2 and 3 are marked with a plus sign (+). Terminal 4 is marked with a minus sign (-). Terminals 8 and 9 are marked with a square symbol. A DC24V supply is connected to terminals 8 and 9, and a 0V supply is connected to terminal 9.

031-1BD40

Technical drawing of the 031-1BD40 module. It includes a perspective view, a front view with dimensions (76.5, 10.4, 10.9, 12.9, 15, 13.3), and a terminal block diagram. The terminal block diagram shows 8 terminals labeled 1 through 8. Terminals 1, 5, 6, and 7 are marked with an ammeter symbol (A). Terminals 2 and 3 are marked with a plus sign (+). Terminal 4 is marked with a minus sign (-). Terminals 8 and 9 are marked with a square symbol. A DC24V supply is connected to terminals 8 and 9, and a 0V supply is connected to terminal 9.

Analog input modules

Signal modules analog Analog input modules					
031-1BB10	031-1BB70	031-1BD70	031-1CB70	031-1CD45	
031-1BB30	031-1BB90	031-1BD80	031-1CD30	031-1CD70	
031-1BB40	031-1BD30	031-1CB30	031-1CD35	031-1LB90	
031-1BB60	031-1BD40	031-1CB40	031-1CD40	031-1LD80	

Order number	031-1BD70	031-1BD80	031-1CB30	031-1CB40
Figure				
Type	SM 031	SM 031	SM 031	SM 031
Module ID	0409 15C4	0406 1544	040A 1543	040B 1543
General information				
Note	-	-	-	-
Features	<ul style="list-style-type: none"> ▶ 4 inputs 12Bit ▶ Voltage -10 V...+10 V 	<ul style="list-style-type: none"> ▶ 4 inputs 16Bit ▶ 0 .. 3000 ohm resistance ▶ Resistance measurement with 2, 3, and 4-wires 	<ul style="list-style-type: none"> ▶ 2 inputs 16Bit ▶ Voltage 0...10 V 	<ul style="list-style-type: none"> ▶ 2 inputs 16Bit ▶ Current 0(4)...20 mA
Current consumption/power loss				
Current consumption from backplane bus	50 mA	75 mA	60 mA	60 mA
Power loss	0.5 W	1 W	0.8 W	0.7 W
Technical data analog inputs				
Number of inputs	4	4	2	2
Cable length, shielded	200 m	200 m	200 m	200 m
Rated load voltage	DC 24 V	DC 24 V	DC 24 V	DC 24 V
Current consumption from load voltage L+ (without load)	15 mA	30 mA	20 mA	15 mA
Voltage inputs	✓	-	✓	-
Min. input resistance (voltage range)	100 kΩ	-	200 kΩ	-
Input voltage ranges	-10 V ... +10 V	-	0 V ... +10 V	-
Operational limit of voltage ranges	+/-0.3%	-	+/-0.2%	-
Operational limit of voltage ranges with SFU	-	-	-	-
Basic error limit voltage ranges	+/-0.2%	-	+/-0.1%	-
Basic error limit voltage ranges with SFU	-	-	-	-
Destruction limit current	-	-	-	-
Current inputs	-	-	-	✓
Max. input resistance (current range)	-	-	-	60 Ω
Input current ranges	-	-	-	0 mA ... +20 mA +4 mA ... +20 mA
Operational limit of current ranges	-	-	-	+/-0.2%
Operational limit of current ranges with SFU	-	-	-	-
Basic error limit current ranges	-	-	-	+/-0.1%
Radical error limit current ranges with SFU	-	-	-	-
Destruction limit current inputs (voltage)	-	-	-	-
Destruction limit current inputs (electrical current)	-	-	-	-
Resistance inputs	-	✓	-	-

Signal modules analog | Analog input modules

031-1BB10	031-1BB70	031-1BD70	031-1CB70	031-1CD45		
031-1BB30	031-1BB90	031-1BD80	031-1CD30	031-1CD70		
031-1BB40	031-1BD30	031-1CB30	031-1CD35	031-1LB90		
031-1BB60	031-1BD40	031-1CB40	031-1CD40	031-1LD80		

Order number	031-1BD70	031-1BD80	031-1CB30	031-1CB40
Resistance ranges	-	0 ... 60 Ohm 0 ... 600 Ohm 0 ... 3000 Ohm	-	-
Operational limit of resistor ranges	-	+/- 0.4 %	-	-
Operational limit of resistor ranges with SFU	-	+/- 0.2 %	-	-
Basic error limit	-	+/- 0.2 %	-	-
Basic error limit with SFU	-	+/- 0.1 %	-	-
Destruction limit resistance inputs	-	-	-	-
Resistance thermometer inputs	-	✓	-	-
Resistance thermometer ranges	-	Pt100 Pt1000 Ni100 Ni1000	-	-
Operational limit of resistance thermometer ranges	-	+/- 0.4 %	-	-
Operational limit of resistance thermometer ranges with SFU	-	+/- 0.2 %	-	-
Basic error limit thermoresistor ranges	-	+/- 0.2 %	-	-
Operational limit of resistance thermometer ranges with SFU	-	+/- 0.1 %	-	-
Destruction limit resistance thermometer inputs	-	-	-	-
Thermocouple inputs	-	-	-	-
Thermocouple ranges	-	-	-	-
Operational limit of thermocouple ranges	-	-	-	-
Operational limit of thermocouple ranges with SFU	-	-	-	-
Basic error limit thermoelement ranges	-	-	-	-
Basic error limit thermoelement ranges with SFU	-	-	-	-
Destruction limit thermocouple inputs	-	-	-	-
Programmable temperature compensation	-	-	-	-
External temperature compensation	-	-	-	-
Internal temperature compensation	-	-	-	-
Internal temperature compensation	-	-	-	-
Technical unit of temperature measurement	-	-	-	-
Resolution in bit	12	16	16	16
Measurement principle	successive approximation	Sigma-Delta	successive approximation	successive approximation
Basic conversion time	4 ms all channels	4.2...324.1 ms (50 Hz) 3.8...270.5 ms (60 Hz) per channel	240 µs all channels	240 µs all channels
Noise suppression for frequency	>50dB at 50Hz (UCM<2V)	>80dB at 50Hz (UCM<6V)	>80dB at 50Hz (UCM<9V)	>80dB (UCM<4V)

Signal modules analog | Analog input modules

031-1BB10	031-1BB70	031-1BD70	031-1CB70	031-1CD45		
031-1BB30	031-1BB90	031-1BD80	031-1CD30	031-1CD70		
031-1BB40	031-1BD30	031-1CB30	031-1CD35	031-1LB90		
031-1BB60	031-1BD40	031-1CB40	031-1CD40	031-1LD80		

Order number	031-1BD70	031-1BD80	031-1CB30	031-1CB40
Status information, alarms, diagnostics				
Status display	yes	yes	yes	yes
Interrupts	no	yes, parameterizable	yes, parameterizable	yes, parameterizable
Process alarm	no	yes, parameterizable	yes, parameterizable	yes, parameterizable
Diagnostic interrupt	no	yes, parameterizable	yes, parameterizable	yes, parameterizable
Diagnostic functions	yes	yes	yes	yes
Diagnostics information read-out	possible	possible	possible	possible
Module state	green LED	green LED	green LED	green LED
Module error display	red LED	red LED	red LED	red LED
Channel error display	red LED per channel	red LED per channel	red LED per channel	red LED per channel
Isolation				
Between channels	-	-	-	-
Between channels of groups to	-	-	-	-
Between channels and backplane bus	✓	✓	✓	✓
Between channels and power supply	✓	-	✓	✓
Max. potential difference between circuits	-	-	-	-
Max. potential difference between inputs (Ucm)	DC 2 V	DC 6 V	DC 9 V	DC 4 V
Max. potential difference between Mana and Mintern (Uiso)	-	-	-	-
Max. potential difference between inputs and Mana (Ucm)	-	-	DC 1 V	DC 3 V
Max. potential difference between inputs and Mintern (Uiso)	DC 75 V/ AC 60 V	DC 75 V/ AC 60 V	DC 75 V/ AC 60 V	DC 75 V/ AC 60 V
Max. potential difference between Mintern and outputs	-	-	-	-
Insulation tested with	DC 500 V	DC 500 V	DC 500 V	DC 500 V
Datasizes				
Input bytes	8	8	4	4
Output bytes	0	0	0	0
Parameter bytes	8	34	20	20
Diagnostic bytes	20	20	20	20
Housing				
Material	PPE / PPE GF10	PPE / PPE GF10	PPE / PPE GF10	PPE / PPE GF10
Mounting	Profile rail 35 mm	Profile rail 35 mm	Profile rail 35 mm	Profile rail 35 mm
Mechanical data				
Dimensions (WxHxD)	12.9 mm x 109 mm x 76.5 mm	12.9 mm x 109 mm x 76.5 mm	12.9 mm x 109 mm x 76.5 mm	12.9 mm x 109 mm x 76.5 mm
Weight	60 g	60 g	60 g	60 g
Environmental conditions				
Operating temperature	0 °C to 60 °C	0 °C to 60 °C	0 °C to 60 °C	0 °C to 60 °C
Storage temperature	-25 °C to 70 °C	-25 °C to 70 °C	-25 °C to 70 °C	-25 °C to 70 °C
Certifications				
UL508 certification	yes	yes	yes	yes

Connections, Interfaces

Signal modules analog | Analog input modules

031-1BB10	031-1BB70	031-1BD70	031-1CB70	031-1CD45		
031-1BB30	031-1BB90	031-1BD80	031-1CD30	031-1CD70		
031-1BB40	031-1BD30	031-1CB30	031-1CD35	031-1LB90		
031-1BB60	031-1BD40	031-1CB40	031-1CD40	031-1LD80		

031-1BD70





031-1BD80

031-1CB30

031-1CB40

Analog input modules

Signal modules analog Analog input modules						
031-1BB10	031-1BB70	031-1BD70	031-1CB70	031-1CD45		
031-1BB30	031-1BB90	031-1BD80	031-1CD30	031-1CD70		
031-1BB40	031-1BD30	031-1CB30	031-1CD35	031-1LB90		
031-1BB60	031-1BD40	031-1CB40	031-1CD40	031-1LD80		

Order number	031-1CB70	031-1CD30	031-1CD35	031-1CD40
Figure				
Type	SM 031	SM 031	SM 031	SM 031
Module ID	040C 1543	040D 1544	0413 15C4	0412 1544
General information				
Note	-	-	-	-
Features	<ul style="list-style-type: none"> ▸ 2 inputs 16Bit ▸ Voltage -10 V...+10 V 	<ul style="list-style-type: none"> ▸ 4 inputs 16Bit ▸ Voltage 0...10 V 	<ul style="list-style-type: none"> ▸ 4 inputs 16Bit ▸ Voltage 0...10 V 	<ul style="list-style-type: none"> ▸ 4 inputs 16Bit ▸ Current 0(4)...20 mA
Current consumption/power loss				
Current consumption from backplane bus	60 mA	60 mA	60 mA	60 mA
Power loss	0.8 W	0.9 W	0.9 W	0.8 W
Technical data analog inputs				
Number of inputs	2	4	4	4
Cable length, shielded	200 m	200 m	200 m	200 m
Rated load voltage	DC 24 V	DC 24 V	DC 24 V	DC 24 V
Current consumption from load voltage L+ (without load)	20 mA	25 mA	25 mA	20 mA
Voltage inputs	✓	✓	✓	-
Min. input resistance (voltage range)	200 kΩ	200 kΩ	200 kΩ	-
Input voltage ranges	-10 V ... +10 V	0 V ... +10 V	0 V ... +10 V	-
Operational limit of voltage ranges	+/-0.2%	+/-0.2%	+/-0.2%	-
Operational limit of voltage ranges with SFU	-	-	-	-
Basic error limit voltage ranges	+/-0.1%	+/-0.1%	+/-0.1%	-
Basic error limit voltage ranges with SFU	-	-	-	-
Destruction limit current	-	-	-	-
Current inputs	-	-	-	✓
Max. input resistance (current range)	-	-	-	60 Ω
Input current ranges	-	-	-	0 mA ... +20 mA +4 mA ... +20 mA
Operational limit of current ranges	-	-	-	+/-0.2%
Operational limit of current ranges with SFU	-	-	-	-
Basic error limit current ranges	-	-	-	+/-0.1%
Radical error limit current ranges with SFU	-	-	-	-
Destruction limit current inputs (voltage)	-	-	-	-
Destruction limit current inputs (electrical current)	-	-	-	-
Resistance inputs	-	-	-	-
Resistance ranges	-	-	-	-
Operational limit of resistor ranges	-	-	-	-
Operational limit of resistor ranges with SFU	-	-	-	-
Basic error limit	-	-	-	-

Signal modules analog | Analog input modules

031-1BB10	031-1BB70	031-1BD70	031-1CB70	031-1CD45		
031-1BB30	031-1BB90	031-1BD80	031-1CD30	031-1CD70		
031-1BB40	031-1BD30	031-1CB30	031-1CD35	031-1LB90		
031-1BB60	031-1BD40	031-1CB40	031-1CD40	031-1LD80		

Order number	031-1CB70	031-1CD30	031-1CD35	031-1CD40
Basic error limit with SFU	-	-	-	-
Destruction limit resistance inputs	-	-	-	-
Resistance thermometer inputs	-	-	-	-
Resistance thermometer ranges	-	-	-	-
Operational limit of resistance thermometer ranges	-	-	-	-
Operational limit of resistance thermometer ranges with SFU	-	-	-	-
Basic error limit thermoresistor ranges	-	-	-	-
Operational limit of resistance thermometer ranges with SFU	-	-	-	-
Destruction limit resistance thermometer inputs	-	-	-	-
Thermocouple inputs	-	-	-	-
Thermocouple ranges	-	-	-	-
Operational limit of thermocouple ranges	-	-	-	-
Operational limit of thermocouple ranges with SFU	-	-	-	-
Basic error limit thermoelement ranges	-	-	-	-
Basic error limit thermoelement ranges with SFU	-	-	-	-
Destruction limit thermocouple inputs	-	-	-	-
Programmable temperature compensation	-	-	-	-
External temperature compensation	-	-	-	-
Internal temperature compensation	-	-	-	-
Internal temperature compensation	-	-	-	-
Technical unit of temperature measurement	-	-	-	-
Resolution in bit	16	16	16	16
Measurement principle	successive approximation	successive approximation	successive approximation	successive approximation
Basic conversion time	240 µs all channels	480 µs all channels	480 µs all channels	240 µs all channels
Noise suppression for frequency	>80dB at 50Hz (UCM<9V)	>80dB at 50Hz (UCM<9V)	>80dB at 50Hz (UCM<9V)	>80dB (UCM<4V)
Status information, alarms, diagnostics				
Status display	yes	yes	yes	yes
Interrupts	yes, parameterizable	yes, parameterizable	no	yes, parameterizable
Process alarm	yes, parameterizable	yes, parameterizable	no	yes, parameterizable
Diagnostic interrupt	yes, parameterizable	yes, parameterizable	no	yes, parameterizable
Diagnostic functions	yes	yes	yes	yes
Diagnostics information read-out	possible	possible	possible	possible
Module state	green LED	green LED	green LED	green LED
Module error display	red LED	red LED	red LED	red LED
Channel error display	red LED per channel	red LED per channel	red LED per channel	red LED per channel

Signal modules analog | Analog input modules

031-1BB10	031-1BB70	031-1BD70	031-1CB70	031-1CD45		
031-1BB30	031-1BB90	031-1BD80	031-1CD30	031-1CD70		
031-1BB40	031-1BD30	031-1CB30	031-1CD35	031-1LB90		
031-1BB60	031-1BD40	031-1CB40	031-1CD40	031-1LD80		

Order number	031-1CB70	031-1CD30	031-1CD35	031-1CD40
Isolation				
Between channels	-	-	-	-
Between channels of groups to	-	-	-	-
Between channels and backplane bus	✓	✓	✓	✓
Between channels and power supply	✓	✓	✓	✓
Max. potential difference between circuits	-	-	-	-
Max. potential difference between inputs (Ucm)	DC 9 V	DC 9 V	DC 9 V	DC 4 V
Max. potential difference between Mana and Mintern (Uiso)	-	-	-	-
Max. potential difference between inputs and Mana (Ucm)	DC 1 V	-	-	-
Max. potential difference between inputs and Mintern (Uiso)	DC 75 V/ AC 60 V	DC 75 V/ AC 60 V	DC 75 V/ AC 60 V	DC 75 V/ AC 60 V
Max. potential difference between Mintern and outputs	-	-	-	-
Insulation tested with	DC 500 V	DC 500 V	DC 500 V	DC 500 V
Datasizes				
Input bytes	4	8	8	8
Output bytes	0	0	0	0
Parameter bytes	20	32	9	32
Diagnostic bytes	20	20	20	20
Housing				
Material	PPE / PPE GF10	PPE / PPE GF10	PPE / PPE GF10	PPE / PPE GF10
Mounting	Profile rail 35 mm	Profile rail 35 mm	Profile rail 35 mm	Profile rail 35 mm
Mechanical data				
Dimensions (WxHxD)	12.9 mm x 109 mm x 76.5 mm	12.9 mm x 109 mm x 76.5 mm	12.9 mm x 109 mm x 76.5 mm	12.9 mm x 109 mm x 76.5 mm
Weight	60 g	60 g	60 g	60 g
Environmental conditions				
Operating temperature	0 °C to 60 °C	0 °C to 60 °C	0 °C to 60 °C	0 °C to 60 °C
Storage temperature	-25 °C to 70 °C	-25 °C to 70 °C	-25 °C to 70 °C	-25 °C to 70 °C
Certifications				
UL508 certification	yes	yes	in preparation	yes

Connections, Interfaces

Signal modules analog | Analog input modules

031-1BB10	031-1BB70	031-1BD70	031-1CB70	031-1CD45		
031-1BB30	031-1BB90	031-1BD80	031-1CD30	031-1CD70		
031-1BB40	031-1BD30	031-1CB30	031-1CD35	031-1LB90		
031-1BB60	031-1BD40	031-1CB40	031-1CD40	031-1LD80		

031-1CB70





031-1CD30

031-1CD35

031-1CD40

Analog input modules

Signal modules analog Analog input modules					
031-1BB10	031-1BB70	031-1BD70	031-1CB70	031-1CD45	
031-1BB30	031-1BB90	031-1BD80	031-1CD30	031-1CD70	
031-1BB40	031-1BD30	031-1CB30	031-1CD35	031-1LB90	
031-1BB60	031-1BD40	031-1CB40	031-1CD40	031-1LD80	

Order number	031-1CD45	031-1CD70	031-1LB90	031-1LD80
Figure				
Type	SM 031	SM 031	SM 031	SM 031
Module ID	0414 15C4	040E 1544	040F 1543	0410 1544
General information				
Note	-	-	-	-
Features	<ul style="list-style-type: none"> ▶ 4 inputs 16Bit ▶ Current 0(4)...20 mA 	<ul style="list-style-type: none"> ▶ 4 inputs 16Bit ▶ Voltage -10 V...+10 V 	<ul style="list-style-type: none"> ▶ 2 inputs 16Bit ▶ Thermocouple ▶ Voltage -80mV...+80mV ▶ requires less parameter bytes than module 031-1BB90 	<ul style="list-style-type: none"> ▶ 4 inputs 16Bit ▶ 0 .. 3000 ohm resistance ▶ Resistance measurement with 2, 3, and 4-wires ▶ requires less parameter bytes than module 031-1BD80
Current consumption/power loss				
Current consumption from backplane bus	60 mA	60 mA	55 mA	55 mA
Power loss	0.8 W	0.9 W	1 W	1 W
Technical data analog inputs				
Number of inputs	4	4	2	4
Cable length, shielded	200 m	200 m	200 m	200 m
Rated load voltage	DC 24 V	DC 24 V	DC 24 V	DC 24 V
Current consumption from load voltage L+ (without load)	20 mA	25 mA	30 mA	30 mA
Voltage inputs	-	✓	-	-
Min. input resistance (voltage range)	-	200 kΩ	10 MΩ	-
Input voltage ranges	-	-10 V ... +10 V	-80 mV ... +80 mV	-
Operational limit of voltage ranges	-	+/-0.2%	±0.3%	-
Operational limit of voltage ranges with SFU	-	-	±0.1%	-
Basic error limit voltage ranges	-	+/-0.1%	±0.25%	-
Basic error limit voltage ranges with SFU	-	-	±0.05%	-
Destruction limit current	-	-	-	-
Current inputs	✓	-	-	-
Max. input resistance (current range)	60 Ω	-	-	-
Input current ranges	0 mA ... +20 mA +4 mA ... +20 mA	-	-	-
Operational limit of current ranges	+/-0.2%	-	-	-
Operational limit of current ranges with SFU	-	-	-	-
Basic error limit current ranges	+/-0.1%	-	-	-
Radical error limit current ranges with SFU	-	-	-	-
Destruction limit current inputs (voltage)	-	-	-	-
Destruction limit current inputs (electrical current)	-	-	-	-
Resistance inputs	-	-	-	✓

Signal modules analog Analog input modules					
031-1BB10	031-1BB70	031-1BD70	031-1CB70	031-1CD45	
031-1BB30	031-1BB90	031-1BD80	031-1CD30	031-1CD70	
031-1BB40	031-1BD30	031-1CB30	031-1CD35	031-1LB90	
031-1BB60	031-1BD40	031-1CB40	031-1CD40	031-1LD80	

Order number	031-1CD45	031-1CD70	031-1LB90	031-1LD80
Resistance ranges	-	-	-	0 ... 60 Ohm 0 ... 600 Ohm 0 ... 3000 Ohm
Operational limit of resistor ranges	-	-	-	+/- 0.4 %
Operational limit of resistor ranges with SFU	-	-	-	+/- 0,2 %
Basic error limit	-	-	-	+/- 0.2 %
Basic error limit with SFU	-	-	-	+/- 0,1 %
Destruction limit resistance inputs	-	-	-	-
Resistance thermometer inputs	-	-	-	✓
Resistance thermometer ranges	-	-	-	Pt100 Pt1000 Ni100 Ni1000
Operational limit of resistance thermometer ranges	-	-	-	+/- 0.4 %
Operational limit of resistance thermometer ranges with SFU	-	-	-	+/- 0,2 %
Basic error limit thermoresistor ranges	-	-	-	+/- 0.2 %
Operational limit of resistance thermometer ranges with SFU	-	-	-	+/- 0,1 %
Destruction limit resistance thermometer inputs	-	-	-	-
Thermocouple inputs	-	-	✓	-
Thermocouple ranges	-	-	type B type C type E type J type K type L type N type R type S type T	-
Operational limit of thermocouple ranges	-	-	Type E, L, T, J, K, N: ±2.5K / Type B, C, R, S: ±8.0K	-
Operational limit of thermocouple ranges with SFU	-	-	Type E, L, T, J, K, N: ±1.5K / Type B, C, R, S: ±4.0K	-
Basic error limit thermoelement ranges	-	-	Type E, L, T, J, K, N: ±2.0K / Type B, C, R, S: ±7.0K	-
Basic error limit thermoelement ranges with SFU	-	-	Type E, L, T, J, K, N: ±1.0K / Type B, C, R, S: ±3.0K	-
Destruction limit thermocouple inputs	-	-	-	-
Programmable temperature compensation	-	-	✓	-
External temperature compensation	-	-	✓	-
Internal temperature compensation	-	-	✓	-
Internal temperature compensation	-	-	1 K	-
Technical unit of temperature measurement	-	-	-	-
Resolution in bit	16	16	16	16

Signal modules analog Analog input modules					
031-1BB10	031-1BB70	031-1BD70	031-1CB70	031-1CD45	
031-1BB30	031-1BB90	031-1BD80	031-1CD30	031-1CD70	
031-1BB40	031-1BD30	031-1CB30	031-1CD35	031-1LB90	
031-1BB60	031-1BD40	031-1CB40	031-1CD40	031-1LD80	

Order number	031-1CD45	031-1CD70	031-1LB90	031-1LD80
Measurement principle	successive approximation	successive approximation	Sigma-Delta	Sigma-Delta
Basic conversion time	240 µs all channels	480 µs all channels	84.2 ms (50 Hz) 70.5 ms (60 Hz) per channel	84.2 ms (50 Hz) 70.5 ms (60 Hz) per channel
Noise suppression for frequency	>80dB (UCM<4V)	>80dB at 50Hz (UCM<35V)	>90dB at 50Hz (UCM<10V)	>80dB at 50Hz (UCM<6V)
Status information, alarms, diagnostics				
Status display	yes	yes	yes	yes
Interrupts	no	yes, parameterizable	yes	yes, parameterizable
Process alarm	no	yes, parameterizable	no	no
Diagnostic interrupt	no	yes, parameterizable	yes, parameterizable	yes, parameterizable
Diagnostic functions	yes	yes	yes	yes
Diagnostics information read-out	possible	possible	possible	possible
Module state	green LED	green LED	green LED	green LED
Module error display	red LED	red LED	red LED	red LED
Channel error display	red LED per channel	red LED per channel	red LED per channel	red LED per channel
Isolation				
Between channels	-	-	-	-
Between channels of groups to	-	-	-	-
Between channels and backplane bus	✓	✓	✓	✓
Between channels and power supply	✓	✓	-	-
Max. potential difference between circuits	-	-	-	-
Max. potential difference between inputs (Ucm)	DC 4 V	DC 9 V	DC 140 V/ AC 60 V	DC 6 V
Max. potential difference between Mana and Mintern (Uiso)	-	-	-	-
Max. potential difference between inputs and Mana (Ucm)	-	-	-	-
Max. potential difference between inputs and Mintern (Uiso)	DC 75 V/ AC 60 V	DC 75 V/ AC 60 V	DC 75 V/ AC 60 V	DC 75 V/ AC 60 V
Max. potential difference between Mintern and outputs	-	-	-	-
Insulation tested with	DC 500 V	DC 500 V	DC 500 V	DC 500 V
Datasizes				
Input bytes	8	8	4	8
Output bytes	0	0	0	0
Parameter bytes	9	32	10	12
Diagnostic bytes	20	20	20	20

Signal modules analog Analog input modules						
031-1BB10	031-1BB70	031-1BD70	031-1CB70	031-1CD45		
031-1BB30	031-1BB90	031-1BD80	031-1CD30	031-1CD70		
031-1BB40	031-1BD30	031-1CB30	031-1CD35	031-1LB90		
031-1BB60	031-1BD40	031-1CB40	031-1CD40	031-1LD80		

Order number	031-1CD45	031-1CD70	031-1LB90	031-1LD80
Housing				
Material	PPE / PPE GF10	PPE / PPE GF10	PPE / PPE GF10	PPE / PPE GF10
Mounting	Profile rail 35 mm	Profile rail 35 mm	Profile rail 35 mm	Profile rail 35 mm
Mechanical data				
Dimensions (WxHxD)	12.9 mm x 109 mm x 76.5 mm	12.9 mm x 109 mm x 76.5 mm	12.9 mm x 109 mm x 76.5 mm	12.9 mm x 109 mm x 76.5 mm
Weight	60 g	60 g	60 g	60 g
Environmental conditions				
Operating temperature	0 °C to 60 °C	0 °C to 60 °C	0 °C to 60 °C	0 °C to 60 °C
Storage temperature	-25 °C to 70 °C	-25 °C to 70 °C	-25 °C to 70 °C	-25 °C to 70 °C
Certifications				
UL508 certification	in preparation	yes	yes	yes

Connections, Interfaces

Signal modules analog | Analog input modules

031-1BB10	031-1BB70	031-1BD70	031-1CB70	031-1CD45		
031-1BB30	031-1BB90	031-1BD80	031-1CD30	031-1CD70		
031-1BB40	031-1BD30	031-1CB30	031-1CD35	031-1LB90		
031-1BB60	031-1BD40	031-1CB40	031-1CD40	031-1LD80		

031-1CD45

031-1CD70





031-1LB90

031-1LD80

Analog output modules

Signal modules analog | Analog output modules

032-1BB30	032-1BD40	032-1CD30			
032-1BB40	032-1BD70	032-1CD70			
032-1BB70	032-1CB30				
032-1BD30	032-1CB70				

Order number	032-1BB30	032-1BB40	032-1BB70	032-1BD30
Figure				
Type	SM 032	SM 032	SM 032	SM 032
Module ID	0501 25D8	0502 25D8	0505 25D8	0503 25E0
General information				
Note	-	-	-	-
Features	<ul style="list-style-type: none"> ▸ 2 outputs 12Bit ▸ Voltage 0...10 V 	<ul style="list-style-type: none"> ▸ 2 outputs 12Bit ▸ Current 0(4)...20 mA 	<ul style="list-style-type: none"> ▸ 2 outputs 12Bit ▸ Voltage -10 V...+10 V 	<ul style="list-style-type: none"> ▸ 4 outputs 12Bit ▸ Voltage 0...10 V
Current consumption/power loss				
Current consumption from backplane bus	80 mA	80 mA	60 mA	80 mA
Power loss	1.2 W	0.8 W	0.8 W	1.2 W
Technical data analog outputs				
Number of outputs	2	2	2	4
Cable length, shielded	200 m	200 m	200 m	200 m
Rated load voltage	DC 24 V	DC 24 V	DC 24 V	DC 24 V
Reverse polarity protection of rated load voltage	✓	✓	✓	✓
Current consumption from load voltage L+ (without load)	-	-	-	-
Voltage output short-circuit protection	✓	-	✓	✓
Voltage outputs	✓	-	✓	✓
Min. load resistance (voltage range)	5 kΩ	-	5 kΩ	5 kΩ
Max. capacitive load (current range)	1 μF	-	1 μF	1 μF
Max. inductive load (current range)	10 mA	-	10 mA	10 mA
Output voltage ranges	0 V ... +10 V	-	-10 V ... +10 V	0 V ... +10 V
Operational limit of voltage ranges	+/-0.3%	-	+/-0.3%	+/-0.3%
Basic error limit voltage ranges	+/-0.2%	-	+/-0.2%	+/-0.2%
Destruction limit against external applied voltage	-	-	-	-
Current outputs	-	✓	-	-
Max. in load resistance (current range)	-	350 Ω	-	-
Max. inductive load (current range)	-	10 mH	-	-
Max. inductive load (current range)	-	12 V	-	-
Output current ranges	-	0 mA ... +20 mA +4 mA ... +20 mA	-	-
Operational limit of current ranges	-	+/-0.4% ... +/-0.5%	-	-
Basic error limit current ranges	-	+/-0.2% ... +/-0.3%	-	-
Destruction limit against external applied voltage	-	-	-	-
Settling time for ohmic load	1.5 ms	0.25 ms	1.5 ms	1.5 ms
Settling time for capacitive load	2 ms	-	2 ms	2 ms
Settling time for inductive load	-	1.5 ms	-	-
Resolution in bit	12	12	12	12

Signal modules analog Analog output modules					
032-1BB30	032-1BD40	032-1CD30			
032-1BB40	032-1BD70	032-1CD70			
032-1BB70	032-1CB30				
032-1BD30	032-1CB70				

Order number	032-1BB30	032-1BB40	032-1BB70	032-1BD30
Conversion time	2 ms all channels	2 ms all channels	2 ms all channels	2 ms all channels
Substitute value can be applied	no	no	no	no
Output data size	4 Byte	4 Byte	4 Byte	8 Byte
Status information, alarms, diagnostics				
Status display	yes	yes	yes	yes
Interrupts	no	no	no	no
Process alarm	no	no	no	no
Diagnostic interrupt	no	no	no	no
Diagnostic functions	yes	yes	yes	yes
Diagnostics information read-out	possible	possible	possible	possible
Supply voltage display	green LED	green LED	green LED	green LED
Group error display	red LED	red LED	red LED	red LED
Channel error display	red LED per channel	red LED per channel	red LED per channel	red LED per channel
Isolation				
Between channels	-	-	-	-
Between channels of groups to	-	-	-	-
Between channels and backplane bus	✓	✓	✓	✓
Between channels and power supply	✓	✓	✓	✓
Max. potential difference between circuits	-	-	-	-
Max. potential difference between inputs (Ucm)	-	-	-	-
Max. potential difference between Mana and Mintern (Uiso)	DC 75 V/ AC 60 V	DC 75 V/ AC 60 V	DC 75 V/ AC 60 V	DC 75 V/ AC 60 V
Max. potential difference between inputs and Mana (Ucm)	-	-	-	-
Max. potential difference between inputs and Mintern (Uiso)	-	-	-	-
Max. potential difference between Mintern and outputs	-	-	-	-
Insulation tested with	DC 500 V	DC 500 V	DC 500 V	DC 500 V
Datasizes				
Input bytes	0	0	0	0
Output bytes	4	4	4	8
Parameter bytes	8	8	8	10
Diagnostic bytes	20	20	20	20
Housing				
Material	PPE / PPE GF10	PPE / PPE GF10	PPE / PPE GF10	PPE / PPE GF10
Mounting	Profile rail 35 mm	Profile rail 35 mm	Profile rail 35 mm	Profile rail 35 mm
Mechanical data				
Dimensions (WxHxD)	12.9 mm x 109 mm x 76.5 mm	12.9 mm x 109 mm x 76.5 mm	12.9 mm x 109 mm x 76.5 mm	12.9 mm x 109 mm x 76.5 mm
Weight	60 g	60 g	60 g	60 g
Environmental conditions				
Operating temperature	0 °C to 60 °C	0 °C to 60 °C	0 °C to 60 °C	0 °C to 60 °C
Storage temperature	-25 °C to 70 °C	-25 °C to 70 °C	-25 °C to 70 °C	-25 °C to 70 °C
Certifications				
UL508 certification	yes	yes	yes	yes

Connections, Interfaces

Signal modules analog Analog output modules					
032-1BB30	032-1BD40	032-1CD30			
032-1BB40	032-1BD70	032-1CD70			
032-1BB70	032-1CB30				
032-1BD30	032-1CB70				

032-1BB30

Technical drawings of the 032-1BB30 module. The drawings include a perspective view, a front view with dimensions (76.5, 10.4, 10.9, 12.9, 15, 13.3), and a terminal block diagram. The terminal block diagram shows 8 pins with connections for DC24V and OV.

032-1BB40

Technical drawings of the 032-1BB40 module. The drawings include a perspective view, a front view with dimensions (76.5, 10.4, 10.9, 12.9, 15, 13.3), and a terminal block diagram. The terminal block diagram shows 8 pins with connections for DC24V and OV.

032-1BB70

Technical drawings of the 032-1BB70 module. The drawings include a perspective view, a front view with dimensions (76.5, 10.4, 10.9, 12.9, 15, 13.3), and a terminal block diagram. The terminal block diagram shows 8 pins with connections for DC24V and OV.





032-1BD30

Technical drawings of the 032-1BD30 module. The drawings include a perspective view, a front view with dimensions (76.5, 10.4, 10.9, 12.9, 15, 13.3), and a terminal block diagram. The terminal block diagram shows 8 pins with connections for DC24V and OV.

Analog output modules

Signal modules analog | Analog output modules

032-1BB30	032-1BD40	032-1CD30			
032-1BB40	032-1BD70	032-1CD70			
032-1BB70	032-1CB30				
032-1BD30	032-1CB70				

Order number	032-1BD40	032-1BD70	032-1CB30	032-1CB70
Figure				
Type	SM 032	SM 032	SM 032	SM 032
Module ID	0504 25E0	0506 25E0	0507 2558	0508 2558
General information				
Note	-	-	-	-
Features	<ul style="list-style-type: none"> ▸ 4 outputs 12Bit ▸ Current 0(4)...20mA 	<ul style="list-style-type: none"> ▸ 4 outputs 12Bit ▸ Voltage -10 V...+10 V 	<ul style="list-style-type: none"> ▸ 2 outputs 16Bit ▸ Voltage 0...+10 V 	<ul style="list-style-type: none"> ▸ 2 outputs 16Bit ▸ Voltage -10 V...+10 V
Current consumption/power loss				
Current consumption from backplane bus	80 mA	60 mA	60 mA	60 mA
Power loss	0.8 W	0.8 W	0.8 W	0.8 W
Technical data analog outputs				
Number of outputs	4	4	2	2
Cable length, shielded	200 m	200 m	200 m	200 m
Rated load voltage	DC 24 V	DC 24 V	DC 24 V	DC 24 V
Reverse polarity protection of rated load voltage	✓	✓	✓	✓
Current consumption from load voltage L+ (without load)	-	-	-	-
Voltage output short-circuit protection	-	✓	✓	✓
Voltage outputs	-	✓	✓	✓
Min. load resistance (voltage range)	-	5 kΩ	5 kΩ	5 kΩ
Max. capacitive load (current range)	-	1 μF	1 μF	1 μF
Max. inductive load (current range)	-	10 mA	10 mA	10 mA
Output voltage ranges	-	-10 V ... +10 V	0 V ... +10 V	-10 V ... +10 V
Operational limit of voltage ranges	-	+/-0.3%	+/-0.2%	+/-0.2%
Basic error limit voltage ranges	-	+/-0.2%	+/-0.1%	+/-0.1%
Destruction limit against external applied voltage	-	-	-	-
Current outputs	✓	-	-	-
Max. in load resistance (current range)	350 Ω	-	-	-
Max. inductive load (current range)	10 mH	-	-	-
Max. inductive load (current range)	12 V	-	-	-
Output current ranges	0 mA ... +20 mA +4 mA ... +20 mA	-	-	-
Operational limit of current ranges	+/-0.4% ... +/-0.5%	-	-	-
Basic error limit current ranges	+/-0.2% ... +/-0.3%	-	-	-
Destruction limit against external applied voltage	-	-	-	-
Settling time for ohmic load	0.25 ms	1.5 ms	150 μs	150 μs
Settling time for capacitive load	-	2 ms	1 ms	1 ms
Settling time for inductive load	1.5 ms	-	-	-
Resolution in bit	12	12	16	16

Signal modules analog | Analog output modules

032-1BB30	032-1BD40	032-1CD30			
032-1BB40	032-1BD70	032-1CD70			
032-1BB70	032-1CB30				
032-1BD30	032-1CB70				

Order number	032-1BD40	032-1BD70	032-1CB30	032-1CB70
Conversion time	2 ms all channels	2 ms all channels	200 µs all channels	200 µs all channels
Substitute value can be applied	no	no	no	no
Output data size	8 Byte	8 Byte	4 Byte	4 Byte
Status information, alarms, diagnostics				
Status display	yes	yes	yes	yes
Interrupts	no	no	no	no
Process alarm	no	no	no	no
Diagnostic interrupt	no	no	no	no
Diagnostic functions	yes	yes	yes	yes
Diagnostics information read-out	possible	possible	possible	possible
Supply voltage display	green LED	green LED	green LED	green LED
Group error display	red LED	red LED	red LED	red LED
Channel error display	red LED per channel	red LED per channel	red LED per channel	red LED per channel
Isolation				
Between channels	-	-	-	-
Between channels of groups to	-	-	-	-
Between channels and backplane bus	✓	✓	✓	✓
Between channels and power supply	✓	✓	✓	✓
Max. potential difference between circuits	-	-	-	-
Max. potential difference between inputs (Ucm)	-	-	-	-
Max. potential difference between Mana and Mintern (Uiso)	DC 75 V/ AC 60 V	DC 75 V/ AC 60 V	DC 75 V/ AC 60 V	DC 75 V/ AC 60 V
Max. potential difference between inputs and Mana (Ucm)	-	-	-	-
Max. potential difference between inputs and Mintern (Uiso)	-	-	-	-
Max. potential difference between Mintern and outputs	-	-	-	-
Insulation tested with	DC 500 V	DC 500 V	DC 500 V	DC 500 V
Datasizes				
Input bytes	0	0	0	0
Output bytes	8	8	4	4
Parameter bytes	10	10	8	8
Diagnostic bytes	20	20	20	20
Housing				
Material	PPE / PPE GF10	PPE / PPE GF10	PPE / PPE GF10	PPE / PPE GF10
Mounting	Profile rail 35 mm	Profile rail 35 mm	Profile rail 35 mm	Profile rail 35 mm
Mechanical data				
Dimensions (WxHxD)	12.9 mm x 109 mm x 76.5 mm	12.9 mm x 109 mm x 76.5 mm	12.9 mm x 109 mm x 76.5 mm	12.9 mm x 109 mm x 76.5 mm
Weight	60 g	60 g	60 g	60 g
Environmental conditions				
Operating temperature	0 °C to 60 °C	0 °C to 60 °C	0 °C to 60 °C	0 °C to 60 °C
Storage temperature	-25 °C to 70 °C	-25 °C to 70 °C	-25 °C to 70 °C	-25 °C to 70 °C
Certifications				
UL508 certification	yes	yes	yes	yes

Connections, Interfaces

Signal modules analog | Analog output modules

032-1BB30	032-1BD40	032-1CD30			
032-1BB40	032-1BD70	032-1CD70			
032-1BB70	032-1CB30				
032-1BD30	032-1CB70				

032-1BD40

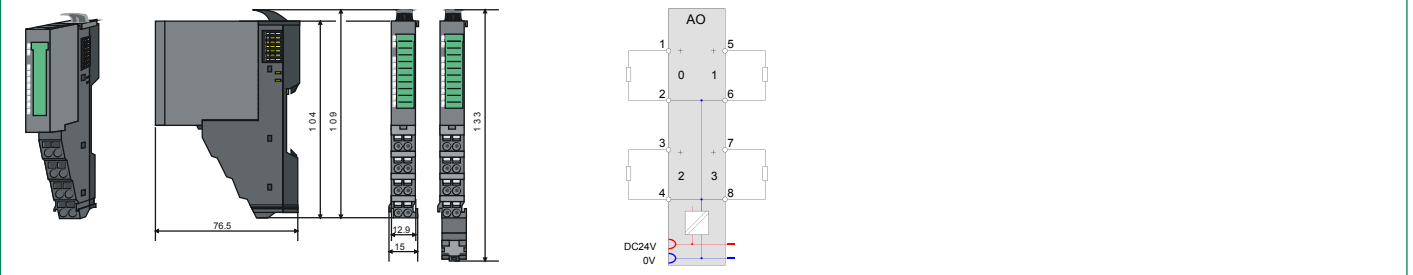

032-1BD70

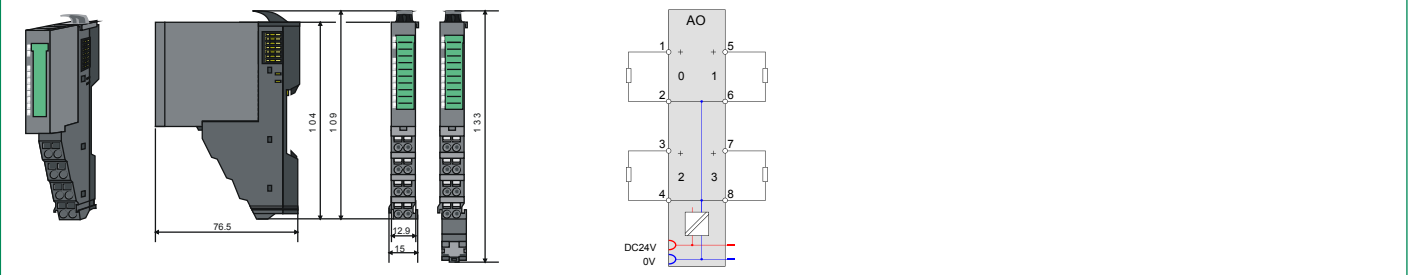

032-1CB30

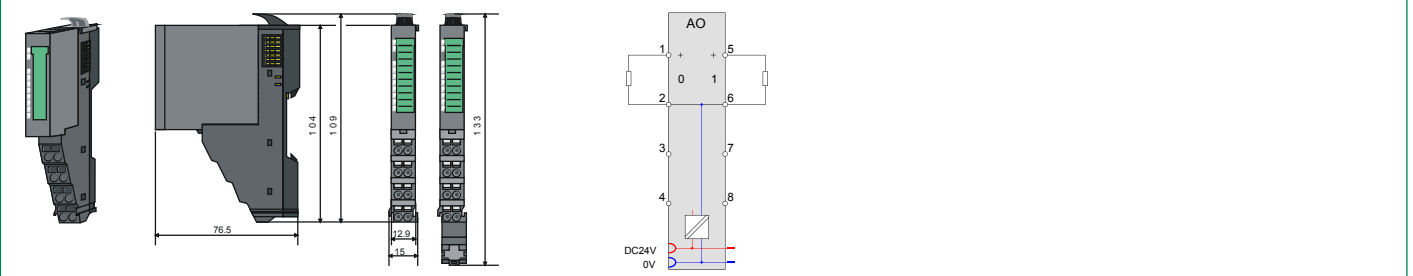

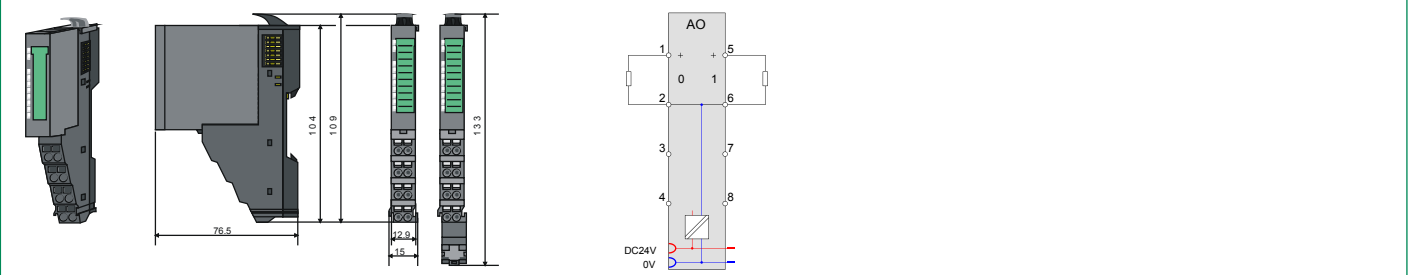

032-1CB70



Analog output modules

Signal modules analog | Analog output modules

032-1BB30	032-1BD40	032-1CD30				
032-1BB40	032-1BD70	032-1CD70				
032-1BB70	032-1CB30					
032-1BD30	032-1CB70					

Order number	032-1CD30	032-1CD70		
Figure				
Type	SM 032	SM 032		
Module ID	0509 2560	050A 2560		
General information				
Note	-	-		
Features	<ul style="list-style-type: none"> ▸ 4 outputs 16Bit ▸ Voltage 0...10 V 	<ul style="list-style-type: none"> ▸ 4 outputs 16Bit ▸ Voltage -10 V...+10 V 		
Current consumption/power loss				
Current consumption from backplane bus	60 mA	60 mA		
Power loss	0.8 W	0.8 W		
Technical data analog outputs				
Number of outputs	4	4		
Cable length, shielded	200 m	200 m		
Rated load voltage	DC 24 V	DC 24 V		
Reverse polarity protection of rated load voltage	✓	✓		
Current consumption from load voltage L+ (without load)	-	-		
Voltage output short-circuit protection	✓	✓		
Voltage outputs	✓	✓		
Min. load resistance (voltage range)	5 kΩ	5 kΩ		
Max. capacitive load (current range)	1 μF	1 μF		
Max. inductive load (current range)	10 mA	10 mA		
Output voltage ranges	0 V ... +10 V	-10 V ... +10 V		
Operational limit of voltage ranges	+/-0.2%	+/-0.2%		
Basic error limit voltage ranges	+/-0.1%	+/-0.1%		
Destruction limit against external applied voltage	-	-		
Current outputs	-	-		
Max. in load resistance (current range)	-	-		
Max. inductive load (current range)	-	-		
Max. inductive load (current range)	-	-		
Output current ranges	-	-		
Operational limit of current ranges	-	-		
Basic error limit current ranges	-	-		
Destruction limit against external applied voltage	-	-		
Settling time for ohmic load	150 μs	150 μs		
Settling time for capacitive load	1 ms	2 ms		
Settling time for inductive load	-	-		
Resolution in bit	16	16		
Conversion time	200 μs all channels	200 μs all channels		

Signal modules analog Analog output modules					
032-1BB30	032-1BD40	032-1CD30			
032-1BB40	032-1BD70	032-1CD70			
032-1BB70	032-1CB30				
032-1BD30	032-1CB70				

Order number	032-1CD30	032-1CD70		
Substitute value can be applied	no	no		
Output data size	8 Byte	8 Byte		
Status information, alarms, diagnostics				
Status display	yes	yes		
Interrupts	no	no		
Process alarm	no	no		
Diagnostic interrupt	no	no		
Diagnostic functions	yes	yes		
Diagnostics information read-out	possible	possible		
Supply voltage display	green LED	green LED		
Group error display	red LED	red LED		
Channel error display	red LED per channel	red LED per channel		
Isolation				
Between channels	-	-		
Between channels of groups to	-	-		
Between channels and backplane bus	✓	✓		
Between channels and power supply	✓	✓		
Max. potential difference between circuits	-	-		
Max. potential difference between inputs (Ucm)	-	-		
Max. potential difference between Mana and Mintern (Uiso)	DC 75 V/ AC 60 V	DC 75 V/ AC 60 V		
Max. potential difference between inputs and Mana (Ucm)	-	-		
Max. potential difference between inputs and Mintern (Uiso)	-	-		
Max. potential difference between Mintern and outputs	-	-		
Insulation tested with	DC 500 V	DC 500 V		
Datasizes				
Input bytes	0	0		
Output bytes	8	8		
Parameter bytes	10	10		
Diagnostic bytes	20	20		
Housing				
Material	PPE / PPE GF10	PPE / PPE GF10		
Mounting	Profile rail 35 mm	Profile rail 35 mm		
Mechanical data				
Dimensions (WxHxD)	12.9 mm x 109 mm x 76.5 mm	12.9 mm x 109 mm x 76.5 mm		
Weight	60 g	60 g		
Environmental conditions				
Operating temperature	0 °C to 60 °C	0 °C to 60 °C		
Storage temperature	-25 °C to 70 °C	-25 °C to 70 °C		
Certifications				
UL508 certification	yes	yes		

Connections, Interfaces

Signal modules analog Analog output modules					
032-1BB30	032-1BD40	032-1CD30			
032-1BB40	032-1BD70	032-1CD70			
032-1BB70	032-1CB30				
032-1BD30	032-1CB70				

032-1CD30

Technical drawing of the 032-1CD30 module. It includes a perspective view, a front view with dimensions (76.5, 10.4, 10.9, 12.9, 1.5, 1.33), and a wiring diagram. The wiring diagram shows two channels with terminals 1-4 and 5-8. Channel 1 has terminals 1 (+), 2, 3 (+), and 4. Channel 2 has terminals 5 (+), 6, 7 (+), and 8. A DC24V supply is connected to terminal 1 and 5, and 0V to terminal 2 and 6.

032-1CD70

Technical drawing of the 032-1CD70 module. It includes a perspective view, a front view with dimensions (76.5, 10.4, 10.9, 12.9, 1.5, 1.33), and a wiring diagram. The wiring diagram is identical to the 032-1CD30 module, showing two channels with terminals 1-4 and 5-8, and a DC24V supply connection.

Communication processors



Structure and Function

Communications processors are used to connect different target and source systems, e.g. via Ethernet to higher-level ERP systems or serially to scanners, printers and other peripherals.

CP 040

The communication processors CP 040 enable the serial process coupling to different target and source systems. Depending on the module they have a RS232 or a RS422/485 interface.

Characteristics

- › Support for all standard protocols ASCII, STX/ETX, 3964(R) and Modbus (master, slave)
- › Internal communication via VIPA FBs
- › Compact design
- › LED status indicator
- › Electrically isolated to the backplane bus
- › Assembly with 35 mm profile rail
- › 24 month warranty

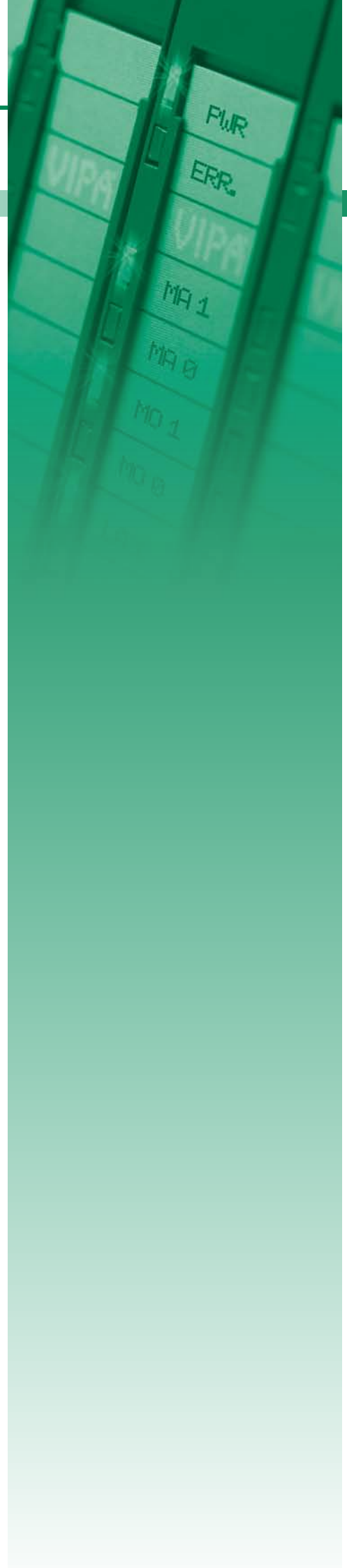

Overview

Order no.	Name/Description	Page
RS232/422/485 and other CPs		
040-1BA00	CP 040 - Communication processor ‣ RS232 interface	110
040-1CA00	CP 040 - Communication processor ‣ RS422/485 interface	110

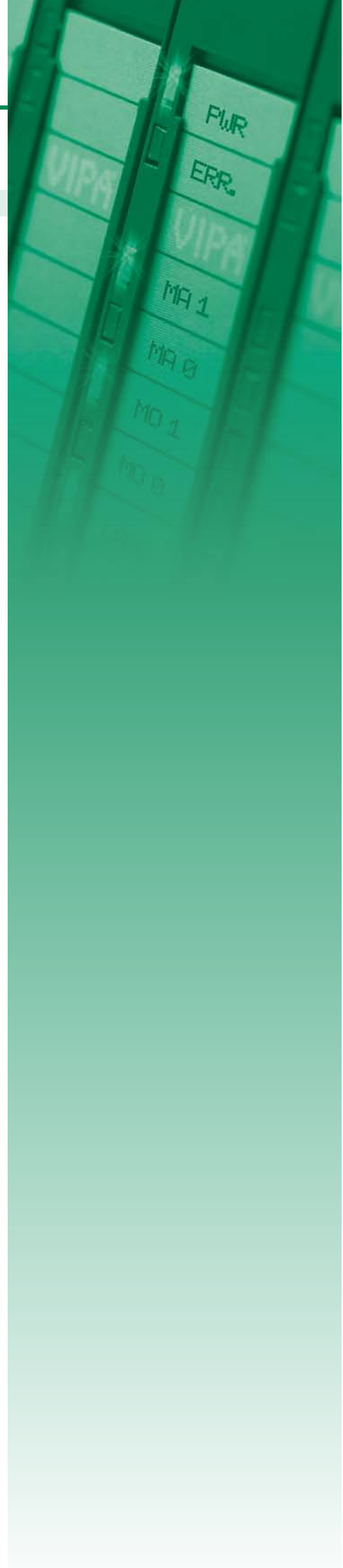

RS232/422/485 and other CPs

Communication processors | RS232/422/485 and other CPs

040-1BA00
040-1CA00

Order number	040-1BA00	040-1CA00		
Figure				
Type	CP 040 RS232	CP 040 RS422/485		
Module ID	0E01 0700	0E41 1700		
General information				
Note	-	-		
Features	▷ RS232 interface	▷ RS422/485 interface		
Current consumption/power loss				
Current consumption from backplane bus	100 mA	100 mA		
Current consumption from load voltage L+ (without load)	10 mA	10 mA		
Power loss	1 W	1 W		
Status information, alarms, diagnostics				
Status display	yes	yes		
Interrupts	yes, parameterizable	yes, parameterizable		
Process alarm	no	no		
Diagnostic interrupt	yes, parameterizable	yes, parameterizable		
Diagnostic functions	yes, parameterizable	yes, parameterizable		
Diagnostics information read-out	possible	possible		
Supply voltage display	green LED	green LED		
Group error display	red LED	red LED		
Channel error display	red LED	red LED		
Point-to-point communication				
PtP communication	✓	✓		
Interface isolated	✓	✓		
RS232 interface	✓	-		
RS422 interface	-	✓		
RS485 interface	-	✓		
Connector	Terminal module	Terminal module		
Transmission speed, min.	150 bit/s	150 bit/s		
Transmission speed, max.	115.2 kbit/s	115.2 kbit/s		
Cable length, max.	15 m	1200 m		
Point-to-point protocol				
ASCII protocol	✓	✓		
STX/ETX protocol	✓	✓		
3964(R) protocol	✓	✓		
RK512 protocol	-	-		
USS master protocol	-	-		
Modbus master protocol	✓	✓		
Modbus slave protocol	✓	✓		
Special protocols	-	-		

Communication processors | RS232/422/485 and other CPs

040-1BA00 040-1CA00						
------------------------	--	--	--	--	--	--

Order number	040-1BA00	040-1CA00		
Datasizes				
Input bytes	8 / 20 / 60	8 / 20 / 60		
Output bytes	8 / 20 / 60	8 / 20 / 60		
Parameter bytes	21	23		
Diagnostic bytes	20	20		
Housing				
Material	PPE / PPE GF10	PPE / PPE GF10		
Mounting	Profile rail 35 mm	Profile rail 35 mm		
Mechanical data				
Dimensions (WxHxD)	12.9 mm x 109 mm x 76.5 mm	12.9 mm x 109 mm x 76.5 mm		
Weight	60 g	60 g		
Environmental conditions				
Operating temperature	0 °C to 60 °C	0 °C to 60 °C		
Storage temperature	-25 °C to 70 °C	-25 °C to 70 °C		
Certifications				
UL508 certification	yes	yes		

Connections, Interfaces

Communication processors RS232/422/485 and other CPs					
040-1BA00					
040-1CA00					

040-1BA00

040-1CA00

Function modules



Structure and Function

Function modules (FM) are intelligent modules that perform technological tasks such as position determination, counting and positioning, and other complex functions in the automation independently. They are used when there are high demands on accuracy and dynamic in the starting of automation tasks.

Different functional modules, for example counter modules, SSI modules provide exactly the functions that are required for the respective tasks.

Each functional module consists of a terminal and an electronic module.

The terminal module (TM) contains the retainer for the electronic module (EM), the backplane connectors and contacts for the distribution of the load power supply electronics, the modular connection to DC 24 V load power supply and the staircase-shaped terminal block for the wiring.

Furthermore the terminal module processes a locking system for fixing to a profile rail. The SLIO system can also be constructed "block by block" outside the cabinet and later assembled as a complete system in the control cabinet.

The functionality of the signal module is defined via the electronic module that is connected by a secure sliding mechanism to the terminal module.

During service the defective electronic module can be replaced without detaching the wiring.

Characteristics

- › Supports fast counter systems up to 1 MHz
- › Counting direction invertible
- › Integrated digital outputs
- › For direct connection of incremental encoders
- › Electrically isolated to the backplane bus
- › Direct mapping and readability of the channel conditions via status LEDs
- › Safe and time-saving installation by the terminal assignment mounted on the module
- › When changing the module equipment identification (BMK) is retained on the TM
- › Individual single-channel lettering on insertion strip
- › 24 month warranty





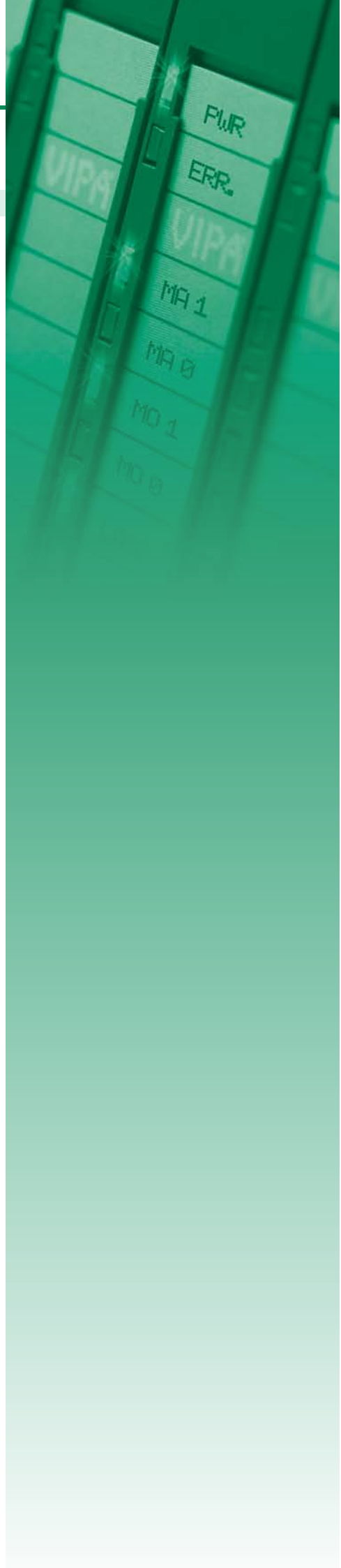

Overview

Order no.	Name/Description	Page
Counter modules		
050-1BA00	FM 050 - Counter module ▶ 1 Counter 32 Bit (AB) ▶ DC 24 V	116
050-1BA10	FM 050 - Counter module ▶ 1 Counter 32 Bit (AB) ▶ DC 5 V (difference signal)	116
050-1BB00	FM 050 - Counter module ▶ 2 Counter 32 Bit (AB) ▶ DC 24 V	116
050-1BB30	FM 050 - Counter module Eco ▶ 2 Counter 32 Bit (AB) ▶ DC 24 V	116
050-1BB40	FM 050 - Frequency measurement ▶ 2 channels 24 Bit ▶ DC 24 V	120
SSI modules		
050-1BS00	FM 050S - SSI module ▶ SSI - Encoder ▶ Master or slave mode ▶ Encoder frequency 125 kHz...2 MHz ▶ µs time stamp for encoder value	124



Counter modules

Function modules Counter modules					
050-1BA00	050-1BB40				
050-1BA10					
050-1BB00					
050-1BB30					

Order number	050-1BA00	050-1BA10	050-1BB00	050-1BB30
Figure				
Type	FM 050	FM 050	FM 050	FM 050
Module ID	08C1 3800	08C2 3801	08C3 380A	08C4 388B
General information				
Note	-	-	-	-
Features	<ul style="list-style-type: none"> ▶ 1 Counter 32 Bit (AB) ▶ DC 24 V 	<ul style="list-style-type: none"> ▶ 1 Counter 32 Bit (AB) ▶ DC 5 V (difference signal) 	<ul style="list-style-type: none"> ▶ 2 Counter 32 Bit (AB) ▶ DC 24 V 	<ul style="list-style-type: none"> ▶ 2 Counter 32 Bit (AB) ▶ DC 24 V
Current consumption/power loss				
Current consumption from backplane bus	75 mA	70 mA	75 mA	75 mA
Power loss	1 W	0.85 W	0.9 W	0.9 W
Technical data digital inputs				
Number of inputs	5	-	4	4
Cable length, shielded	100 m	100 m	100 m	100 m
Cable length, unshielded	-	-	-	-
Rated load voltage	DC 20.4...28.8 V	DC 20.4...28.8 V	DC 20.4...28.8 V	DC 20.4...28.8 V
Reverse polarity protection of rated load voltage	-	-	-	-
Current consumption from load voltage L+ (without load)	20 mA	20 mA	15 mA	15 mA
Rated value	DC 20.4...28.8 V	-	DC 20.4...28.8 V	DC 20.4...28.8 V
Input voltage for signal "0"	DC 0...5 V	Differential signal RS422	DC 0...5 V	DC 0...5 V
Input voltage for signal "1"	DC 15...28.8 V	Differential signal RS422	DC 15...28.8 V	DC 15...28.8 V
Input voltage hysteresis	-	-	-	-
Frequency range	-	-	-	-
Input resistance	-	120 Ω	-	-
Input current for signal "1"	3 mA	-	3 mA	3 mA
Connection of Two-Wire-BEROs possible	✓	-	✓	✓
Max. permissible BERO quiescent current	0.5 mA	-	0.5 mA	0.5 mA
Input delay of "0" to "1"	0.8 μs	0.8 μs	0.8 μs	0.8 μs
Input delay of "1" to "0"	0.8 μs	0.8 μs	0.8 μs	0.8 μs
Number of simultaneously utilizable inputs horizontal configuration	5	-	4	4
Number of simultaneously utilizable inputs vertical configuration	5	-	4	4
Input characteristic curve	IEC 61131-2, type 1	-	IEC 61131-2, type 1	IEC 61131-2, type 1
Initial data size	12 Byte	8 Byte	12 Byte	12 Byte
Technical data digital outputs				
Number of outputs	1	-	-	-
Cable length, shielded	100 m	-	-	-
Cable length, unshielded	100 m	-	-	-
Rated load voltage	DC 20.4...28.8 V	-	-	-

Function modules Counter modules						
050-1BA00 050-1BA10 050-1BB00 050-1BB30	050-1BB40					

Order number	050-1BA00	050-1BA10	050-1BB00	050-1BB30
Current consumption from load voltage L+ (without load)	-	-	-	-
Output delay of "0" to "1"	30 µs	-	-	-
Output delay of "1" to "0"	30 µs	-	-	-
Minimum load current	-	-	-	-
Lamp load	10 W	-	-	-
Parallel switching of outputs for redundant control of a load	not possible	-	-	-
Parallel switching of outputs for increased power	not possible	-	-	-
Actuation of digital input	✓	-	-	-
Switching frequency with resistive load	max. 10 kHz	-	-	-
Switching frequency with inductive load	max. 0.5 Hz	-	-	-
Switching frequency on lamp load	max. 10 kHz	-	-	-
Internal limitation of inductive shut-off voltage	L+ (-52 V)	-	-	-
Short-circuit protection of output	yes, electronic	-	-	-
Trigger level	1 A	-	-	-
Number of operating cycle of relay outputs	-	-	-	-
Switching capacity of contacts	-	-	-	-
Output data size	10 Byte	10 Byte	12 Byte	4 Byte
Technical data counters				
Number of counters	1	1	2	2
Counter width	32 Bit	32 Bit	32 Bit	32 Bit
Maximum input frequency	100 kHz	500 kHz	100 kHz	100 kHz
Maximum count frequency	400 kHz	2 MHz	400 kHz	400 kHz
Mode incremental encoder	✓	✓	✓	✓
Mode pulse / direction	✓	✓	✓	✓
Mode pulse	-	-	-	-
Mode frequency counter	-	-	-	-
Mode period measurement	-	-	-	-
Gate input available	✓	-	-	-
Latch input available	✓	-	-	-
Reset input available	✓	✓	-	-
Counter output available	✓	-	-	-
Status information, alarms, diagnostics				
Status display	yes	yes	yes	yes
Interrupts	yes, parameterizable	yes, parameterizable	yes, parameterizable	no
Process alarm	yes, parameterizable	yes, parameterizable	yes, parameterizable	no
Diagnostic interrupt	yes, parameterizable	yes, parameterizable	yes, parameterizable	no
Diagnostic functions	yes, parameterizable	yes, parameterizable	yes, parameterizable	no
Diagnostics information read-out	possible	possible	possible	possible
Module state	green LED	green LED	green LED	green LED
Module error display	red LED	red LED	red LED	red LED
Channel error display	none	none	none	none

Function modules | Counter modules

050-1BA00	050-1BB40					
050-1BA10						
050-1BB00						
050-1BB30						

Order number	050-1BA00	050-1BA10	050-1BB00	050-1BB30
Isolation				
Between channels	-	-	-	-
Between channels of groups to	-	-	-	-
Between channels and backplane bus	✓	✓	✓	✓
Between channels and power supply	-	-	-	-
Max. potential difference between circuits	-	-	-	-
Max. potential difference between inputs (Ucm)	-	-	-	-
Max. potential difference between Mana and Mintern (Uiso)	-	-	-	-
Max. potential difference between inputs and Mana (Ucm)	-	-	-	-
Max. potential difference between inputs and Mintern (Uiso)	-	-	-	-
Max. potential difference between Mintern and outputs	-	-	-	-
Insulation tested with	DC 500 V	DC 500 V	DC 500 V	DC 500 V
Datasizes				
Input bytes	12	8	12	12
Output bytes	10	10	12	4
Parameter bytes	25	23	45	12
Diagnostic bytes	20	20	20	20
Housing				
Material	PPE / PPE GF10	PPE / PPE GF10	PPE / PPE GF10	PPE / PPE GF10
Mounting	Profile rail 35 mm	Profile rail 35 mm	Profile rail 35 mm	Profile rail 35 mm
Mechanical data				
Dimensions (WxHxD)	12.9 mm x 109 mm x 76.5 mm	12.9 mm x 109 mm x 76.5 mm	12.9 mm x 109 mm x 76.5 mm	12.9 mm x 109 mm x 76.5 mm
Weight	60 g	60 g	60 g	60 g
Environmental conditions				
Operating temperature	0 °C to 60 °C	0 °C to 60 °C	0 °C to 60 °C	0 °C to 60 °C
Storage temperature	-25 °C to 70 °C	-25 °C to 70 °C	-25 °C to 70 °C	-25 °C to 70 °C
Certifications				
UL508 certification	yes	yes	yes	yes

Connections, Interfaces

Function modules Counter modules					
050-1BA00	050-1BB40				
050-1BA10					
050-1BB00					
050-1BB30					

050-1BA00

050-1BA10

050-1BB00

050-1BB30

Counter modules

Function modules Counter modules						
050-1BA00	050-1BB40					
050-1BA10						
050-1BB00						
050-1BB30						

Order number	050-1BB40			
Figure				
Type	FM 050			
Module ID	0881 2880			
General information				
Note	-			
Features	<ul style="list-style-type: none"> ▸ 2 channels 24 Bit ▸ DC 24 V 			
Current consumption/power loss				
Current consumption from backplane bus	35 mA			
Power loss	0.5 W			
Technical data digital inputs				
Number of inputs	2			
Cable length, shielded	100 m			
Cable length, unshielded	-			
Rated load voltage	DC 20.4...28.8 V			
Reverse polarity protection of rated load voltage	-			
Current consumption from load voltage L+ (without load)	5 mA			
Rated value	DC 20.4...28.8 V			
Input voltage for signal "0"	DC 0...5 V			
Input voltage for signal "1"	DC 15...28.8 V			
Input voltage hysteresis	-			
Frequency range	-			
Input resistance	-			
Input current for signal "1"	3 mA			
Connection of Two-Wire-BEROs possible	✓			
Max. permissible BERO quiescent current	0.5 mA			
Input delay of "0" to "1"	0.8 µs			
Input delay of "1" to "0"	0.8 µs			
Number of simultaneously utilizable inputs horizontal configuration	2			
Number of simultaneously utilizable inputs vertical configuration	2			
Input characteristic curve	IEC 61131-2, type 1			
Initial data size	20 Byte			
Technical data digital outputs				
Number of outputs	-			
Cable length, shielded	-			
Cable length, unshielded	-			
Rated load voltage	-			

Function modules Counter modules						
050-1BA00 050-1BA10 050-1BB00 050-1BB30	050-1BB40					

Order number	050-1BB40			
Current consumption from load voltage L+ (without load)	-			
Output delay of "0" to "1"	-			
Output delay of "1" to "0"	-			
Minimum load current	-			
Lamp load	-			
Parallel switching of outputs for redundant control of a load	-			
Parallel switching of outputs for increased power	-			
Actuation of digital input	-			
Switching frequency with resistive load	-			
Switching frequency with inductive load	-			
Switching frequency on lamp load	-			
Internal limitation of inductive shut-off voltage	-			
Short-circuit protection of output	-			
Trigger level	-			
Number of operating cycle of relay outputs	-			
Switching capacity of contacts	-			
Output data size	12 Byte			
Technical data counters				
Number of counters	2			
Counter width	24 Bit			
Maximum input frequency	600 kHz			
Maximum count frequency	600 kHz			
Mode incremental encoder	-			
Mode pulse / direction	-			
Mode pulse	-			
Mode frequency counter	✓			
Mode period measurement	✓			
Gate input available	-			
Latch input available	-			
Reset input available	-			
Counter output available	-			
Status information, alarms, diagnostics				
Status display	yes			
Interrupts	no			
Process alarm	no			
Diagnostic interrupt	no			
Diagnostic functions	no			
Diagnostics information read-out	possible			
Module state	green LED			
Module error display	red LED			
Channel error display	none			

Function modules Counter modules						
050-1BA00	050-1BB40					
050-1BA10						
050-1BB00						
050-1BB30						

Order number	050-1BB40			
Isolation				
Between channels	-			
Between channels of groups to	-			
Between channels and backplane bus	✓			
Between channels and power supply	-			
Max. potential difference between circuits	-			
Max. potential difference between inputs (Ucm)	-			
Max. potential difference between Mana and Mintern (Uiso)	-			
Max. potential difference between inputs and Mana (Ucm)	-			
Max. potential difference between inputs and Mintern (Uiso)	-			
Max. potential difference between Mintern and outputs	-			
Insulation tested with	DC 500 V			
Datasizes				
Input bytes	20			
Output bytes	12			
Parameter bytes	8			
Diagnostic bytes	20			
Housing				
Material	PPE / PPE GF10			
Mounting	Profile rail 35 mm			
Mechanical data				
Dimensions (WxHxD)	12.9 mm x 109 mm x 76.5 mm			
Weight	60 g			
Environmental conditions				
Operating temperature	0 °C to 60 °C			
Storage temperature	-25 °C to 70 °C			
Certifications				
UL508 certification	in preparation			

Connections, Interfaces

Function modules	Counter modules					
050-1BA00 050-1BA10 050-1BB00 050-1BB30	050-1BB40					

050-1BB40

The technical drawing includes three views of the module: a perspective view on the left, a top view in the middle, and a side view on the right. Dimensions are provided in millimeters: 76.5 (width), 104 (height to top of connector), 109 (height to bottom of connector), 12.9 (connector height), 15 (connector offset), and 133 (total height). To the right is a pinout diagram for the 8-pin connector, labeled 'FM'. The pins are numbered 1 through 8. Pin 1 is connected to a terminal block labeled '0'. Pin 2 is connected to a terminal block labeled '1'. Pin 3 is connected to a terminal block labeled '1'. Pin 4 is connected to a terminal block labeled '1'. Pin 5 is connected to a terminal block labeled '0'. Pin 6 is connected to a terminal block labeled '1'. Pin 7 is connected to a terminal block labeled '1'. Pin 8 is connected to a terminal block labeled '1'. Power connections are shown at the bottom: DC24V (red) and 0V (blue).

SSI modules

Function modules | SSI modules

050-1BS00

Order number

050-1BS00

Figure



Type

FM 050

Module ID

09C1 7800

General information

Note

-

Features

- SSI - Encoder
- Master or slave mode
- Encoder frequency 125 kHz...2 MHz
- µs time stamp for encoder value

Current consumption/power loss

Current consumption from backplane bus

70 mA

Power loss

1 W

Parallel switching of outputs for increased power

-

Status information, alarms, diagnostics

Status display

yes

Interrupts

yes, parameterizable

Process alarm

no

Diagnostic interrupt

yes, parameterizable

Diagnostic functions

yes, parameterizable

Diagnostics information read-out

possible

Module state

green LED

Module error display

red LED

Channel error display

none

Isolation

Between channels

-

Between channels of groups to

-

Between channels and backplane bus

✓

Between channels and power supply

-

Max. potential difference between circuits

-

Max. potential difference between inputs (Ucm)

-

Max. potential difference between Mana and Mintern (Uiso)

-

Max. potential difference between inputs and Mana (Ucm)

-

Max. potential difference between inputs and Mintern (Uiso)

-

Max. potential difference between Mintern and outputs

-

Insulation tested with

DC 500 V

Function modules SSI modules						
050-1BS00						

Order number	050-1BS00			
Datasizes				
Input bytes	6			
Output bytes	0			
Parameter bytes	17			
Diagnostic bytes	20			
Housing				
Material	PPE / PPE GF10			
Mounting	Profile rail 35 mm			
Mechanical data				
Dimensions (WxHxD)	12.9 mm x 109 mm x 76.5 mm			
Weight	60 g			
Environmental conditions				
Operating temperature	0 °C to 60 °C			
Storage temperature	-25 °C to 70 °C			
Certifications				
UL508 certification	yes			

Connections, Interfaces

Function modules SSI modules						
050-1BS00						

050-1BS00

The technical drawing includes the following elements:

- Dimensions:**
 - Overall width: 76.5
 - Module height: 104
 - Terminal block height: 109
 - Terminal block width: 12.9
 - Terminal block offset: 15
 - Terminal block depth: 133
- Pinout Diagram:**
 - Terminal 1: CO+
 - Terminal 2: CO-
 - Terminal 3: DI+
 - Terminal 4: DI-
 - Terminal 5: FM
 - Terminal 6: +
 - Terminal 7: -
 - Terminal 8: CI-
 - Terminal 9: CI+
 - Terminal 10: DC24V
 - Terminal 11: 0V

Interface modules



Structure and Function

Interface modules (IM) form the interface between process level and parent bus system. All control signals are transmitted through the internal backplane bus to the electronics module (EM).

In the case of the interface module the bus interface and power module (PM) are integrated in a single casing. Both the bus interface and the electronics of the connected peripheral modules are supplied with power via the integrated power module.

Up to 64 I/O modules can be operated on the interface module.

Characteristics

- › Support for various fieldbus systems
- › Functional DIP switches for address setting for the PROFIBUS-DP and CANopen with transparent cover
- › MAC address on the front in plain text
- › Electrical isolation between fieldbus and input/output field
- › Integrated DC 24 V power module to the electronic and load voltage supply of the peripheral modules
- › Easy to maintain, replaceable power module
- › Up to 64 signal and function modules per interface module
- › 24 month warranty





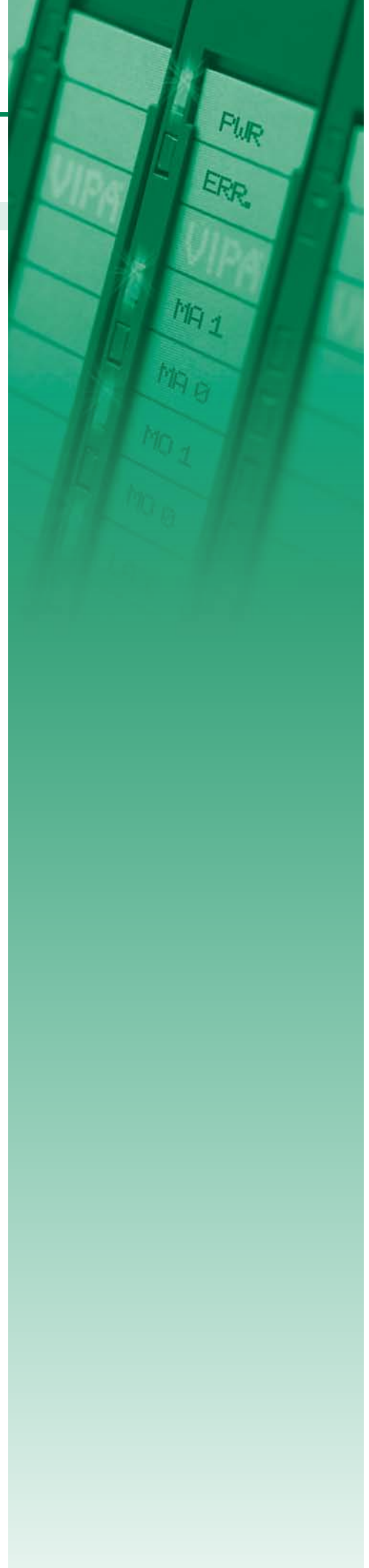

Overview

Order no.	Name/Description	Page
Fieldbus slave modules without I/Os		
053-1CA00	IM 053CAN - CANopen slave <ul style="list-style-type: none"> › CANopen slave › 16 Rx and 16 Tx PDOs › 2 SDOs › PDO linking › PDO mapping: fix › up to 64 peripheral modules 	130
053-1DN00	IM 053DN - DeviceNet slave <ul style="list-style-type: none"> › DeviceNet slave › Group 2 only device › Poll only device › Baud rate: 125, 250 and 500kbit/s › up to 64 peripheral modules 	130
053-1DP00	IM 053DP - PROFIBUS-DP slave <ul style="list-style-type: none"> › PROFIBUS-DP slave (DP-V0, DP-V1) › 244 Byte input and 244 Byte output data › up to 64 peripheral modules 	130
053-1EC00	IM 053EC - EtherCAT slave <ul style="list-style-type: none"> › EtherCAT slave › RJ45 jack 100BaseTX › up to 64 peripheral modules 	130
053-1IP00	IM 053IP - EtherNet/IP slave <ul style="list-style-type: none"> › EtherNet/IP-Slave › I/O configuration via fieldbus › up to 64 peripheral modules 	133
053-1MT00	IM 053MT - Modbus/TCP slave <ul style="list-style-type: none"> › Modbus/TCP slave › I/O configuration via fieldbus › up to 64 peripheral modules 	133
053-1PN00	IM 053PN - PROFINET-IO slave <ul style="list-style-type: none"> › PROFINET-IO slave › Transfer rate 100Mbit/s › up to 64 peripheral modules 	133



Fieldbus slave modules without I/Os

Interface modules Fieldbus slave modules without I/Os					
053-1CA00	053-1IP00				
053-1DN00	053-1MT00				
053-1DP00	053-1PN00				
053-1EC00					

Order number	053-1CA00	053-1DN00	053-1DP00	053-1EC00
Figure				
Type	IM 053CAN	IM 053DN	IM 053DP	IM 053EC
Module ID	-	-	-	-
General information				
Note	-	-	-	-
Features	<ul style="list-style-type: none"> ‣ CANopen slave ‣ 16 Rx and 16 Tx PDOs ‣ 2 SDOs ‣ PDO linking ‣ PDO mapping: fix ‣ up to 64 peripheral modules 	<ul style="list-style-type: none"> ‣ DeviceNet slave ‣ Group 2 only device ‣ Poll only device ‣ Baud rate: 125, 250 and 500kbit/s ‣ up to 64 peripheral modules 	<ul style="list-style-type: none"> ‣ PROFIBUS-DP slave (DP-V0, DP-V1) ‣ 244 Byte input and 244 Byte output data ‣ up to 64 peripheral modules 	<ul style="list-style-type: none"> ‣ EtherCAT slave ‣ RJ45 jack 100BaseTX ‣ up to 64 peripheral modules
Technical data power supply				
Power supply (rated value)	DC 24 V	DC 24 V	DC 24 V	DC 24 V
Power supply (permitted range)	DC 20.4...28.8 V	DC 20.4...28.8 V	DC 20.4...28.8 V	DC 20.4...28.8 V
Reverse polarity protection	✓	✓	✓	✓
Current consumption (no-load operation)	90 mA	90 mA	90 mA	95 mA
Current consumption (rated value)	0.95 A	0.95 A	0.95 A	0.95 A
Inrush current	3.9 A	3.9 A	3.9 A	3.9 A
I _{Δt}	0.14 A ² s	0.14 A ² s	0.14 A ² s	0.14 A ² s
Max. current drain at backplane bus	3 A	3 A	3 A	3 A
Max. current drain load supply	10 A	10 A	10 A	10 A
Power loss	3 W	3 W	3 W	3 W
Status information, alarms, diagnostics				
Status display	yes	yes	yes	yes
Interrupts	yes, parameterizable	-	yes, parameterizable	yes, parameterizable
Process alarm	no	-	yes, parameterizable	yes, parameterizable
Diagnostic interrupt	yes, parameterizable	-	yes, parameterizable	yes, parameterizable
Diagnostic functions	yes, parameterizable	-	yes, parameterizable	yes, parameterizable
Diagnostics information read-out	possible	possible	possible	possible
Supply voltage display	green LED	green LED	green LED	green LED
Service Indicator	-	-	-	-
Group error display	red LED	red SF LED	red LED	red SF LED
Channel error display	none	none	none	none
Hardware configuration				
Racks, max.	1	1	1	1
Modules per rack, max.	64	64	64	64
Number of digital modules, max.	64	64	64	64
Number of analog modules, max.	64	64	64	64

Interface modules Fieldbus slave modules without I/Os						
053-1CA00	053-1IP00					
053-1DN00	053-1MT00					
053-1DP00	053-1PN00					
053-1EC00						

Order number	053-1CA00	053-1DN00	053-1DP00	053-1EC00
Communication				
Fieldbus	CANopen	DeviceNet	PROFIBUS-DP to EN 50170	EtherCAT
Type of interface	CAN	CAN	RS485 isolated	Ethernet 100 MBit
Connector	Sub-D, 9-pin, male	5-pin Open Style Connector	Sub-D, 9-pin, female	2 x RJ45
Topology	Linear bus with bus termination at both ends	Linear bus with bus termination at both ends	Linear bus with bus termination at both ends	-
Electrically isolated	✓	✓	✓	✓
Number of participants, max.	127	64	125	65535
Node addresses	1 - 127	0 - 63	1 - 125	-
Transmission speed, min.	10 kbit/s	125 kbit/s	9.6 kbit/s	100 Mbit/s
Transmission speed, max.	1 Mbit/s	500 kbit/s	12 Mbit/s	100 Mbit/s
Address range inputs, max.	128 Byte	256 Byte	244 Byte	512 Byte
Address range outputs, max.	128 Byte	256 Byte	244 Byte	512 Byte
Number of TxPDOs, max.	16	-	-	-
Number of RxPDOs, max.	16	-	-	-
Housing				
Material	PPE / PPE GF10	PPE / PPE GF10	PPE / PPE GF10	PPE / PPE GF10
Mounting	Profile rail 35 mm	Profile rail 35 mm	Profile rail 35 mm	Profile rail 35 mm
Mechanical data				
Dimensions (WxHxD)	48.5 mm x 109 mm x 76.5 mm	48.5 mm x 109 mm x 76.5 mm	48.5 mm x 109 mm x 76.5 mm	48.5 mm x 109 mm x 76.5 mm
Weight	155 g	155 g	155 g	155 g
Environmental conditions				
Operating temperature	0 °C to 60 °C	0 °C to 60 °C	0 °C to 60 °C	0 °C to 60 °C
Storage temperature	-25 °C to 70 °C	-25 °C to 70 °C	-25 °C to 70 °C	-25 °C to 70 °C
Certifications				
UL508 certification	yes	yes	yes	yes

Connections, Interfaces

Interface modules		Fieldbus slave modules without I/Os				
053-1CA00	053-1IP00					
053-1DN00	053-1MT00					
053-1DP00	053-1PN00					
053-1EC00						

053-1CA00

PM

- 1: DC 24 V
- 2: 0 V
- 3: Sys DC 24 V
- 4: DC 24 V

CAN

- ① n.c.
- ② CAN low
- ③ CAN Ground
- ④ n.c.
- ⑤ n.c.
- ⑥ CAN high
- ⑦ n.c.
- ⑧ n.c.

053-1DN00

PM

- 1: DC 24 V
- 2: 0 V
- 3: Sys DC 24 V
- 4: DC 24 V

DeviceNet

- V- ① GND/optional
- CL ② CAN low
- DR ③ Drain/Shield
- CH ④ CAN high
- V+ ⑤ DC 24 V/optional

053-1DP00

PM

- 1: DC 24 V
- 2: 0 V
- 3: Sys DC 24 V
- 4: DC 24 V

DP slave

- ① shield
- ② n.c.
- ③ RxD/TxD-P (line B)
- ④ RTS
- ⑤ MSV
- ⑥ PSV
- ⑦ n.c.
- ⑧ RxD/TxD-N (line A)
- ⑨ n.c.

053-1EC00

PM



- 1: DC 24 V
- 2: 0 V
- 3: Sys DC 24 V
- 4: DC 24 V

2x RJ45 EtherCAT

- ① Transmit +
- ② Transmit -
- ③ Receive +
- ④ -
- ⑤ -
- ⑥ Receive -
- ⑦ -
- ⑧ -

Fieldbus slave modules without I/Os

Interface modules Fieldbus slave modules without I/Os						
053-1CA00 053-1DN00 053-1DP00 053-1EC00	053-1IP00 053-1MT00 053-1PN00					

Order number	053-1IP00	053-1MT00	053-1PN00	
Figure				
Type	IM 053IP	IM 053MT	IM 053PN	
Module ID	-	-	-	
General information				
Note	-	-	-	
Features	<ul style="list-style-type: none"> ▸ EtherNet/IP-Slave ▸ I/O configuration via fieldbus ▸ up to 64 peripheral modules 	<ul style="list-style-type: none"> ▸ Modbus/TCP slave ▸ I/O configuration via fieldbus ▸ up to 64 peripheral modules 	<ul style="list-style-type: none"> ▸ PROFINET-IO slave ▸ Transfer rate 100Mbit/s ▸ up to 64 peripheral modules 	
Technical data power supply				
Power supply (rated value)	DC 24 V	DC 24 V	DC 24 V	
Power supply (permitted range)	DC 20.4...28.8 V	DC 20.4...28.8 V	DC 20.4...28.8 V	
Reverse polarity protection	✓	✓	✓	
Current consumption (no-load operation)	95 mA	95 mA	95 mA	
Current consumption (rated value)	0.95 A	0.95 A	0.95 A	
Inrush current	3.9 A	3.9 A	3.9 A	
I²t	0.14 A²s	0.14 A²s	0.14 A²s	
Max. current drain at backplane bus	3 A	3 A	3 A	
Max. current drain load supply	10 A	10 A	10 A	
Power loss	3 W	3 W	3 W	
Status information, alarms, diagnostics				
Status display	yes	yes	yes	
Interrupts	yes, parameterizable	yes, parameterizable	yes, parameterizable	
Process alarm	yes, parameterizable	yes, parameterizable	yes, parameterizable	
Diagnostic interrupt	yes, parameterizable	yes, parameterizable	yes, parameterizable	
Diagnostic functions	yes, parameterizable	yes, parameterizable	yes, parameterizable	
Diagnostics information read-out	possible	possible	possible	
Supply voltage display	green LED	green LED	green LED	
Service Indicator	Bicolour green/red LED	yellow LED	yellow LED	
Group error display	red SF LED	red SF LED	red SF LED	
Channel error display	none	none	none	
Hardware configuration				
Racks, max.	1	1	1	
Modules per rack, max.	64	64	64	
Number of digital modules, max.	64	64	64	
Number of analog modules, max.	64	64	64	
Communication				
Fieldbus	EtherNet/IP	Modbus / TCP/IP	PROFINET-IO	
Type of interface	Ethernet 10/100 MBit	Ethernet 10/100 MBit	Ethernet 100 MBit	
Connector	RJ45	RJ45	2 x RJ45	
Topology	Star topology	-	-	

Interface modules Fieldbus slave modules without I/Os					
053-1CA00	053-1IP00				
053-1DN00	053-1MT00				
053-1DP00	053-1PN00				
053-1EC00					

Order number	053-1IP00	053-1MT00	053-1PN00	
Electrically isolated	✓	✓	✓	
Number of participants, max.	-	-	-	
Node addresses	IP V4 address	-	-	
Transmission speed, min.	10 Mbit/s	10 Mbit/s	100 Mbit/s	
Transmission speed, max.	100 Mbit/s	100 Mbit/s	100 Mbit/s	
Address range inputs, max.	1 KB	1 KB	512 Byte	
Address range outputs, max.	1 KB	1 KB	512 Byte	
Number of TxPDOs, max.	-	-	-	
Number of RxPDOs, max.	-	-	-	
Housing				
Material	PPE / PPE GF10	PPE / PPE GF10	PPE / PPE GF10	
Mounting	Profile rail 35 mm	Profile rail 35 mm	Profile rail 35 mm	
Mechanical data				
Dimensions (WxHxD)	48.5 mm x 109 mm x 76.5 mm	48.5 mm x 109 mm x 76.5 mm	48.5 mm x 109 mm x 76.5 mm	
Weight	155 g	155 g	155 g	
Environmental conditions				
Operating temperature	0 °C to 60 °C	0 °C to 60 °C	0 °C to 60 °C	
Storage temperature	-25 °C to 70 °C	-25 °C to 70 °C	-25 °C to 70 °C	
Certifications				
UL508 certification	yes	yes	yes	

Connections, Interfaces

Interface modules | Fieldbus slave modules without I/Os

053-1CA00
053-1DN00
053-1DP00
053-1EC00

053-1IP00
053-1MT00
053-1PN00

053-1IP00

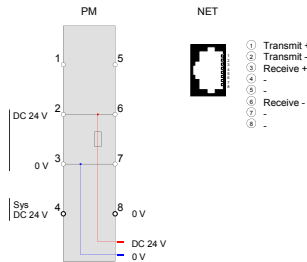
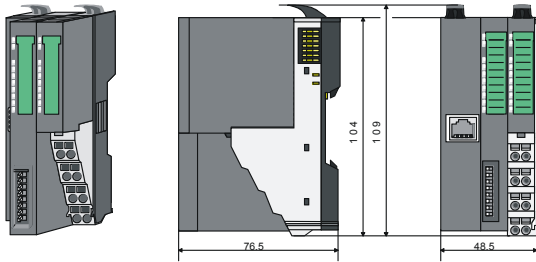

053-1MT00

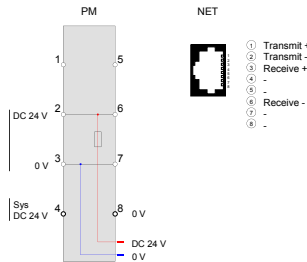
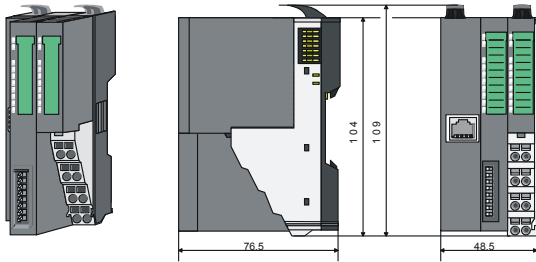

053-1PN00

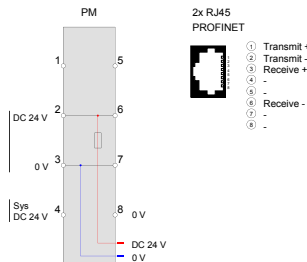
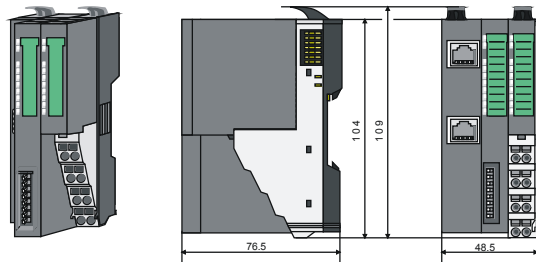

SLIO accessories



Structure and Function

System accessories expand the use of the system and facilitate starting.

35 mm profile rail

Using 35 mm profile rails the respective modules can be mounted directly on the mounting surface. The profile rail is available in various lengths.

Manuals

The technical documentation of the respective modules includes various manuals with the necessary hardware and programming information, detailed descriptions of each module, and instructions for structure and assembly.

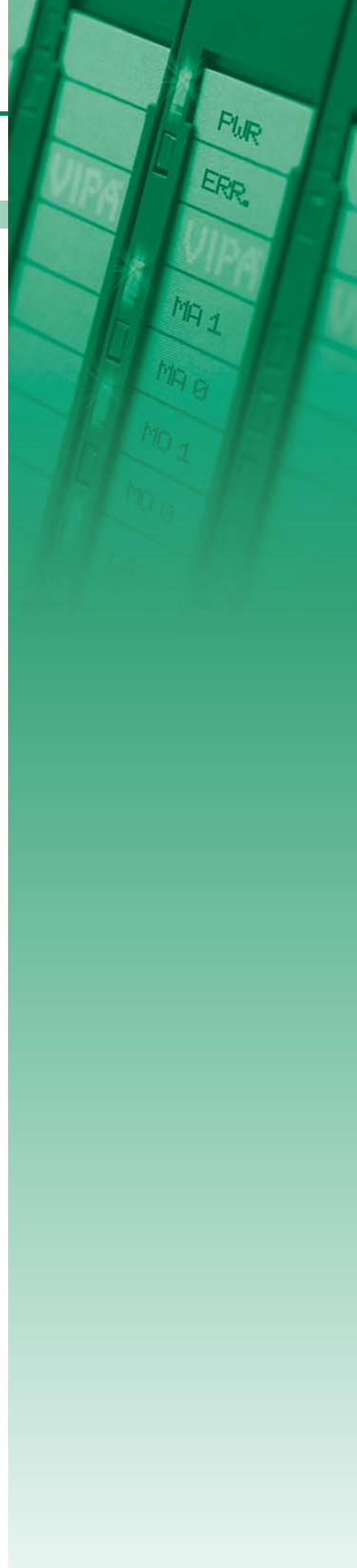

35 mm profile rail



Order number	Type	Description	Note
290-1AF00	35 mm profile rail	length 2000 mm	
290-1AF30	35 mm profile rail	length 530 mm	

Miscellaneous



Order number	Type	Description	Note
000-0AA00	SLIO bus cover		
000-0AB00	SLIO shield bus carrier	10 pieces	
000-0AC00	SLIO shield bus carrier	10 pieces	
000-0DN00	SLIO bus cover		

Manuals and operating instructions



Order number	Title	Contents	Language
HB300D_CPU	Manual System SLIO - German	CPU 01x, incl. operations list	DE
HB300E_CPU	Manual System SLIO - German	CPU 01x, incl. operations list	EN
HB300D	Manual System SLIO - German	Manual System SLIO - Compendium, German HB300D_CPU, HB300D_CP, HB300D_SM-DIO, HB300D_SM-AIO, HB300D_IM, HB300D_FM, HB300D_PS-CM	DE
HB300E	Manual System SLIO - English	Manual System SLIO - Compendium, English HB300E_CPU, HB300E_CP, HB300E_SM-DIO, HB300E_SM-AIO, HB300E_IM, HB300E_FM, HB300E_PS-CM	EN
HB300D_CP	Manual System SLIO - German	CP - Communication processor	DE
HB300E_CP	Manual System SLIO - English	CP - Communication processor	EN
HB300D_FM	Manual System SLIO - German	FM - Function modules	DE
HB300E_FM	Manual System SLIO - English	FM - Function modules	EN
HB300D_IM	Manual System SLIO - German	IM - Interface modules	DE
HB300E_IM	Manual System SLIO - English	IM - Interface modules	EN
HB300D_PS-CM	Manual System SLIO - German	PS-CM - Power modules / Clamp modules	DE
HB300E_PS-CM	Manual System SLIO - English	PS-CM - Power modules / Clamps modules	EN
HB300D_SM-AIO	Manual System SLIO - German	SM-AIO - Analog Signal modules	DE
HB300E_SM-AIO	Manual System SLIO - English	SM-AIO - Analog Signal modules	EN
HB300D_SM-DIO	Manual System SLIO - German	SM-DIO - Digital Signal modules	DE
HB300E_SM-DIO	Manual System SLIO - English	SM-DIO - Digital Signal modules	EN
HB300D_SM-S	Manual System SLIO - German	SM-DIO - Safety Digital Signal modules	DE
HB300E_SM-S	Manual System SLIO - English	SM-DIO - Safety Digital Signal modules	EN

At a glance

System description 100V	142
CPUs	144
Clamp modules	190
Signal modules digital	194
Signal modules analog	204
Interface modules	212
100V accessories	238



| 100V

System description 100V

Structure and Function

100V is a very compact control system.

The system is designed for centralized and decentralized automation tasks.

The compact CPUs unify interfaces for communication and digital I/O peripherals in a casing.

By the use of up to four expansion modules the CPUs can be extended by up to 160 analog and digital I/O points.

With its space-saving assembly size it fits into almost any automation environment.

100V is immediately usable central and decentral without further components. The installation of the system and the enlargement of the periphery is extremely simple. The CPU is clipped onto a standard 35 mm profile rail. If the CPU needs to be expanded bus connectors are used for communication between the CPU and expansion modules on the profile rail in advance, after that the CPU and the 100V/200V expansion modules are snapped on - finished.

The scope of supply includes front connectors, labeling strips and, in 100V expansion modules, also bus connectors.

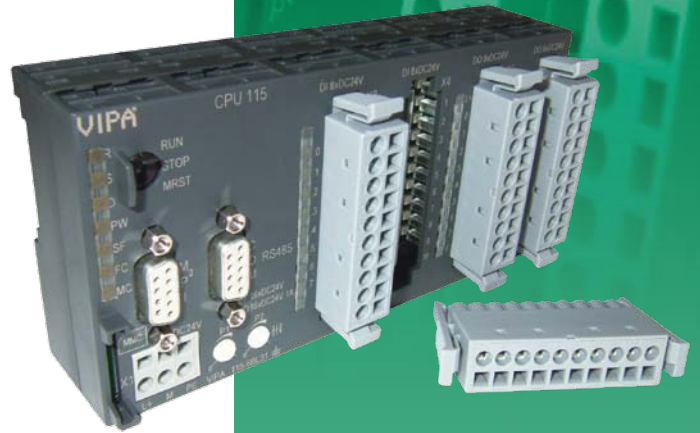

Performance and Application

100V is designed for centralized and decentralized automation tasks in the manufacturing and process industries for the lower performance range.

Programming

100V is programmed with VIPA WinPLC7 or with Siemens STEP7 in LAD, FBD and STL.

Memory

The CPUs in the system 100V have the work and load memory already integrated. Depending on the CPU version, users can choose from 8 kByte to 32 kByte work memory. In addition, MMC cards for storing program and data are supported.

Functions

For the connection of sensors and actuators are a variety of signaling modules in 100V, and 200V for acquiring digital and analog signals in and out of the process is available. Most of the signal modules from 200V are bus and functionally compatible to 100V.

Depending on the CPU, variant counter inputs and PWM outputs are integrated. Due to the counter inputs, complex and fast counting tasks in the manufacturing and process industries will be economically realized. The adjustable PWM outputs via potentiometer allow, for example, CCFLs to be "dimmed" or the speed of appropriate electric motors and fans to be regulated via impulses.

Communication

For the connection of serial devices, e.g. scanner or printer, and for the integration of systems from other manufacturers, different CPU variants are available with integrated interfaces. 100V provides fieldbus slave modules for PROFIBUS-DP and CANopen, with which the system also serves as manufacturer-independent, central, but also as subordinate decentralized fieldbus slave unit.

The fieldbus slave modules are integrated via the device master files into existing fieldbus infrastructure.

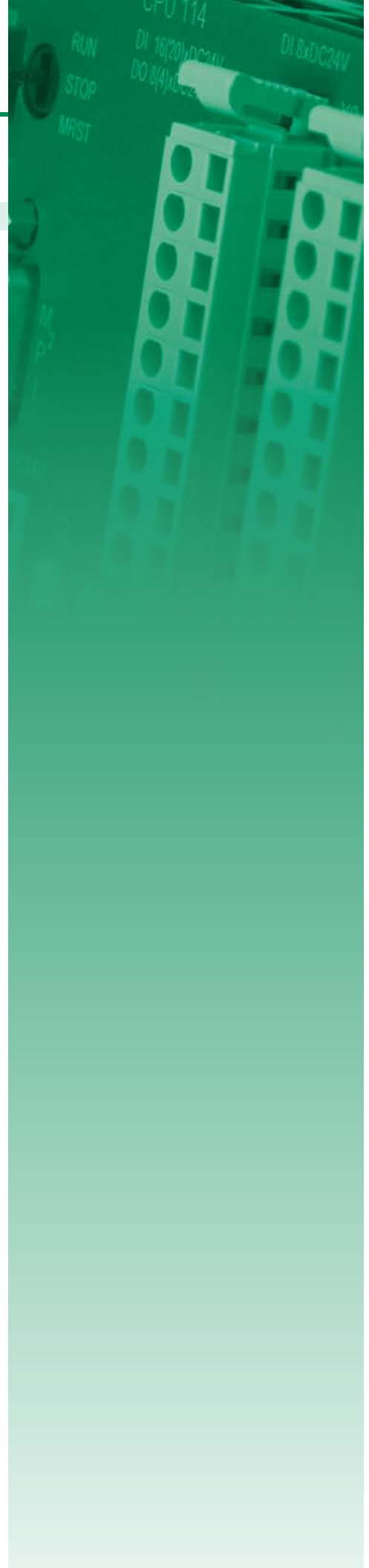

CPUs



CPUs-Central Modules

Central Processing Units (CPU) control and regulate processes in plant and machinery. The CPUs are selected according to application with the appropriate performance and memory and can be extended with signal and function modules, as well as communication processors.

The 100V compact CPUs (micro-PLC) have already integrated the inputs and outputs and are designed for small to medium applications.

Furthermore, each CPU has a front slot for a memory module as well as an MP² interface. The CPU11x supports the standard MPI protocol, serial point-to-point communications. Thereby, in connection with the "Green Cable" from VIPA, a direct and cost-effective programming is possible.

The CPU of the system 100V is ideal for use in control systems with a limited number of inputs and outputs, where previously the use of a PLC was dispensed with. Moreover, this CPU series offers the expansion capability with I/O modules of the system 200V.

Characteristics

- › Programmable with WinPLC7 or Siemens STEP7 (WinPLC7 lite included)
- › Integrated work memory, operation without additional memory card
- › Integrated flash ROM memory for continuous saving of program and data
- › Integrated accumulator-backed RAM memory
- › Support of standard MMC cards for saving of program and data
- › MPI-Interface on board
- › Suitable for centralized and decentralized applications
- › Front integrated status LEDs
- › Expandable with up to four signal and function modules
- › Integrated real time clock
- › Compact design and modular construction
- › Maintenance-free cage-clamp technology
- › Front connector included
- › Assembly with 35 mm profile rail
- › 24 months warranty



Overview

Order no.	Name/Description	Page
CPUs STEP7 programmable		
112-4BH02	CPU 112 - Micro PLC ▶ 8 (12) inputs ▶ 8 (4) outputs ▶ 8 kB work memory, 16 kB load memory	147
114-6BJ02	CPU 114 - Micro PLC ▶ 16 (20) inputs ▶ 8 (4) outputs ▶ from which are 2 PWM 50 kHz outputs ▶ 16 kB work memory, 24 kB load memory	147
114-6BJ03	CPU 114 - Micro PLC ▶ 16 (20) inputs ▶ 8 (4) outputs ▶ from which are 2 PWM 50 kHz outputs ▶ 24 kB work memory, 32 kB load memory	147
114-6BJ04	CPU 114 - Micro PLC ▶ 16 (20) inputs ▶ 8 (4) outputs ▶ from which are 2 PWM 50 kHz outputs ▶ 32 kB work memory, 40 kB load memory	147
114-6BJ52	CPU 114R - Micro PLC ▶ 16 inputs ▶ 8 relay outputs ▶ AC 230 V/ DC 30 V ▶ 16 kB work memory, 24 kB load memory	154
114-6BJ53	CPU 114R - Micro PLC ▶ 16 inputs ▶ 8 relay outputs ▶ AC 230 V/ DC 30 V ▶ 24 kB work memory, 32 kB load memory	154
114-6BJ54	CPU 114R - Micro PLC ▶ 16 inputs ▶ 8 relay outputs ▶ AC 230 V/ DC 30 V ▶ 32 kB work memory, 40 kB load memory	154
115-6BL02	CPU 115 - Micro PLC ▶ 16 (20) inputs ▶ 16 (12) outputs ▶ from which are 2 PWM 50 kHz outputs ▶ 16 kB work memory, 24 kB load memory	154
115-6BL03	CPU 115 - Micro PLC ▶ 16 (20) inputs ▶ 16 (12) outputs ▶ from which are 2 PWM 50 kHz outputs ▶ 24 kB work memory, 32 kB load memory	161
115-6BL04	CPU 115 - Micro PLC ▶ 16 (20) inputs ▶ 16 (12) outputs ▶ from which are 2 PWM 50 kHz outputs ▶ 32 kB work memory, 40 kB load memory	161
CPUs STEP7 programmable, PtP		
115-6BL12	CPU 115SER - Micro PLC ▶ 16 (20) inputs ▶ 16 (12) outputs ▶ from which are 2 PWM 50 kHz outputs ▶ 16 kB work memory, 24 kB load memory ▶ RS232 interface	168
115-6BL13	CPU 115SER - Micro PLC ▶ 16 (20) inputs ▶ 16 (12) outputs ▶ from which are 2 PWM 50 kHz outputs ▶ 24 kB work memory, 32 kB load memory ▶ RS232 interface	168
115-6BL14	CPU 115SER - Micro PLC ▶ 16 (20) inputs ▶ 16 (12) outputs ▶ from which are 2 PWM 50 kHz outputs ▶ 32 kB work memory, 40 kB load memory ▶ RS232 interface	168

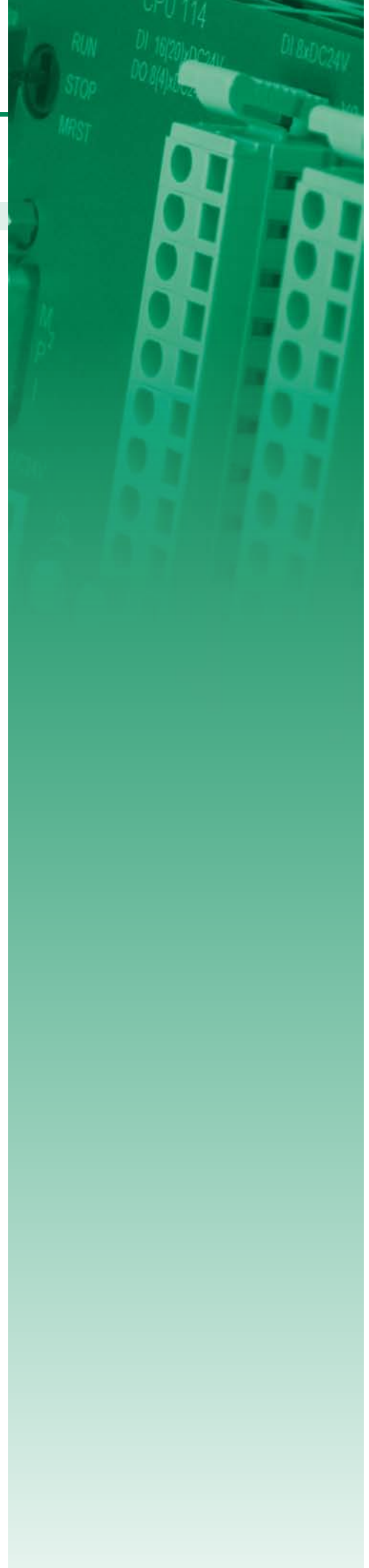



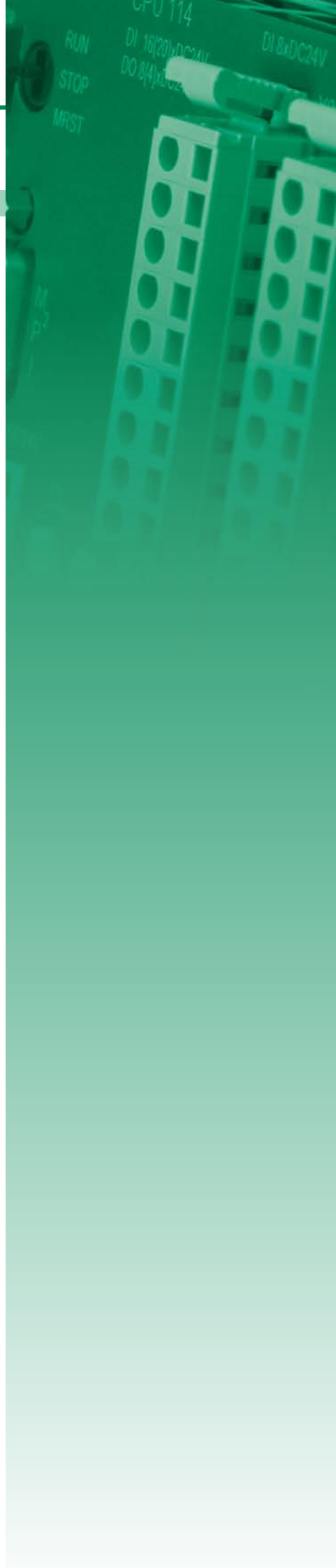

Overview

Order no.	Name/Description	Page
115-6BL32	CPU 115SER - Micro PLC <ul style="list-style-type: none"> › 16 (20) inputs › 16 (12) outputs › from which are 2 PWM 50 kHz outputs › 16 kB work memory, 24 kB load memory › RS485 interface 	168
115-6BL33	CPU 115SER - Micro PLC <ul style="list-style-type: none"> › 16 (20) inputs › 16 (12) outputs › from which are 2 PWM 50 kHz outputs › 24 kB work memory, 32 kB load memory › RS485 interface 	175
115-6BL34	CPU 115SER - Micro PLC <ul style="list-style-type: none"> › 16 (20) inputs › 16 (12) outputs › from which are 2 PWM 50 kHz outputs › 32 kB work memory, 40 kB load memory › RS485 interface 	175
CPUs STEP7 programmable, DP slave		
115-6BL22	CPU 115DP - Micro PLC <ul style="list-style-type: none"> › 16 (20) inputs › 16 (12) outputs › 16 kB work memory, 24 kB load memory › PROFIBUS-DP slave interface 	182
115-6BL23	CPU 115DP - Micro PLC <ul style="list-style-type: none"> › 16 (20) inputs › 16 (12) outputs › from which are 2 PWM 50 kHz outputs › 24 kB work memory, 32 kB load memory › PROFIBUS-DP slave interface 	182
115-6BL24	CPU 115DP - Micro PLC <ul style="list-style-type: none"> › 16 (20) inputs › 16 (12) outputs › 32 kB work memory, 40 kB load memory › PROFIBUS-DP slave interface 	182



CPUs STEP7 programmable

CPUs CPUs STEP7 programmable				
112-4BH02	114-6BJ52	115-6BL03		
114-6BJ02	114-6BJ53	115-6BL04		
114-6BJ03	114-6BJ54			
114-6BJ04	115-6BL02			

Order number	112-4BH02	114-6BJ02	114-6BJ03	114-6BJ04
Figure				
Type	CPU 112	CPU 114	CPU 114	CPU 114
General information				
Note	-	-	-	-
Features	<ul style="list-style-type: none"> ▶ 8 (12) inputs ▶ 8 (4) outputs ▶ 8 kB work memory, 16 kB load memory 	<ul style="list-style-type: none"> ▶ 16 (20) inputs ▶ 8 (4) outputs ▶ from which are 2 PWM 50 kHz outputs ▶ 16 kB work memory, 24 kB load memory 	<ul style="list-style-type: none"> ▶ 16 (20) inputs ▶ 8 (4) outputs ▶ from which are 2 PWM 50 kHz outputs ▶ 24 kB work memory, 32 kB load memory 	<ul style="list-style-type: none"> ▶ 16 (20) inputs ▶ 8 (4) outputs ▶ from which are 2 PWM 50 kHz outputs ▶ 32 kB work memory, 40 kB load memory
Technical data power supply				
Power supply (rated value)	DC 24 V	DC 24 V	DC 24 V	DC 24 V
Power supply (permitted range)	DC 20.4...28.8 V	DC 20.4...28.8 V	DC 20.4...28.8 V	DC 20.4...28.8 V
Reverse polarity protection	✓	✓	✓	✓
Current consumption (no-load operation)	50 mA	80 mA	80 mA	80 mA
Current consumption (rated value)	1 A	1 A	1 A	1 A
Inrush current	58 A	58 A	58 A	58 A
I _{Δt}	0.38 A ² s	0.38 A ² s	0.38 A ² s	0.38 A ² s
Max. current drain at backplane bus	-	0.8 A	0.8 A	0.8 A
Power loss	5 W	7 W	7 W	7 W
Reverse polarity protection	✓	✓	✓	✓
Technical data digital inputs				
Number of inputs	8 (12)	16 (20)	16 (20)	16 (20)
Cable length, shielded	1000 m	1000 m	1000 m	1000 m
Cable length, unshielded	600 m	600 m	600 m	600 m
Rated load voltage	DC 24 V	DC 24 V	DC 24 V	DC 24 V
Reverse polarity protection of rated load voltage	✓	✓	✓	✓
Current consumption from load voltage L+ (without load)	-	-	-	-
Rated value	DC 24 V	DC 24 V	DC 24 V	DC 24 V
Input voltage for signal "0"	DC 0...5 V	DC 0...5 V	DC 0...5 V	DC 0...5 V
Input voltage for signal "1"	DC 15...28.8 V	DC 15...28.8 V	DC 15...28.8 V	DC 15...28.8 V
Input current for signal "1"	7 mA	7 mA	7 mA	7 mA
Connection of Two-Wire-BERs possible	✓	✓	✓	✓
Max. permissible BERO quiescent current	1.5 mA	1.5 mA	1.5 mA	1.5 mA
Input delay of "0" to "1"	3 ms	3 ms	3 ms	3 ms
Input delay of "1" to "0"	3 ms	3 ms	3 ms	3 ms
Input characteristic curve	IEC 61131-2, type 1	IEC 61131-2, type 1	IEC 61131-2, type 1	IEC 61131-2, type 1
Initial data size	3 Byte	3 Byte	3 Byte	3 Byte

CPU CPU STEP7 programmable					
112-4BH02	114-6BJ52	115-6BL03			
114-6BJ02	114-6BJ53	115-6BL04			
114-6BJ03	114-6BJ54				
114-6BJ04	115-6BL02				

Order number	112-4BH02	114-6BJ02	114-6BJ03	114-6BJ04
Technical data digital outputs				
Number of outputs	8 (4)	8 (4)	8 (4)	8 (4)
Cable length, shielded	1000 m	1000 m	1000 m	1000 m
Cable length, unshielded	600 m	600 m	600 m	600 m
Rated load voltage	DC 24 V	DC 24 V	DC 24 V	DC 24 V
Reverse polarity protection of rated load voltage	-	-	-	-
Current consumption from load voltage L+ (without load)	50 mA	50 mA	50 mA	50 mA
Total current per group, horizontal configuration, 40°C	4 A	4 A	4 A	4 A
Total current per group, horizontal configuration, 60°C	4 A	4 A	4 A	4 A
Total current per group, vertical configuration	4 A	4 A	4 A	4 A
Output voltage signal "1" at min. current	L+ (-125 mV)	L+ (-125 mV)	L+ (-125 mV)	L+ (-125 mV)
Output voltage signal "1" at max. current	L+ (-0.8 V)	L+ (-0.8 V)	L+ (-0.8 V)	L+ (-0.8 V)
Output current at signal "1", rated value	0.5 A	0.5 A	0.5 A	0.5 A
Output delay of "0" to "1"	max. 100 µs	max. 100 µs	max. 100 µs	max. 100 µs
Output delay of "1" to "0"	max. 350 µs	max. 350 µs	max. 350 µs	max. 350 µs
Minimum load current	-	-	-	-
Lamp load	5 W	5 W	5 W	5 W
Switching frequency with resistive load	max. 1000 Hz	max. 1000 Hz	max. 1000 Hz	max. 1000 Hz
Switching frequency with inductive load	max. 0.5 Hz	max. 0.5 Hz	max. 0.5 Hz	max. 0.5 Hz
Switching frequency on lamp load	max. 10 Hz	max. 10 Hz	max. 10 Hz	max. 10 Hz
Internal limitation of inductive shut-off voltage	L+ (-52 V)	L+ (-52 V)	L+ (-52 V)	L+ (-52 V)
Short-circuit protection of output	yes, electronic	yes, electronic	yes, electronic	yes, electronic
Trigger level	1 A	1 A	1 A	1 A
Output data size	3 Byte	3 Byte	3 Byte	3 Byte
Technical data counters				
Number of counters	-	4	4	4
Counter width	-	32 Bit	32 Bit	32 Bit
Maximum input frequency	-	30 kHz	30 kHz	30 kHz
Maximum count frequency	-	30 kHz	30 kHz	30 kHz
Mode incremental encoder	-	✓	✓	✓
Mode pulse / direction	-	✓	✓	✓
Mode pulse	-	✓	✓	✓
Mode frequency counter	-	-	-	-
Mode period measurement	-	-	-	-
Gate input available	-	✓	✓	✓
Latch input available	-	-	-	-
Reset input available	-	-	-	-
Counter output available	-	-	-	-

SLIO
100V
200V
300S
500S
HMI
Teleservice
StarterKits
Safety
Solutions
Software
Accessories
Appendix

CPUs CPUs STEP7 programmable					
112-4BH02	114-6BJ52	115-6BL03			
114-6BJ02	114-6BJ53	115-6BL04			
114-6BJ03	114-6BJ54				
114-6BJ04	115-6BL02				

Order number	112-4BH02	114-6BJ02	114-6BJ03	114-6BJ04
Status information, alarms, diagnostics				
Status display	yes	yes	yes	yes
Interrupts	yes	yes	yes	yes
Process alarm	yes	yes	yes	yes
Diagnostic interrupt	yes	yes	yes	yes
Diagnostic functions	no	no	no	no
Diagnostics information read-out	possible	possible	possible	possible
Supply voltage display	green LED	green LED	green LED	green LED
Group error display	red SF LED	red SF LED	red SF LED	red SF LED
Channel error display	none	none	none	none
Isolation				
Between channels of groups to	8	8	8	8
Between channels and backplane bus	✓	✓	✓	✓
Insulation tested with	DC 500 V	DC 500 V	DC 500 V	DC 500 V
PWM data				
PWM channels	-	2	2	2
PWM time basis	-	-	-	-
Period length	-	-	-	-
Minimum pulse width	-	-	-	-
PtP communication	-	-	-	-
Load and working memory				
Load memory, integrated	16 KB	24 KB	32 KB	40 KB
Load memory, maximum	16 KB	24 KB	32 KB	40 KB
Work memory, integrated	8 KB	16 KB	24 KB	32 KB
Work memory, maximal	8 KB	16 KB	24 KB	32 KB
Memory divided in 50% program / 50% data	-	-	-	-
Memory card slot	MMC-Card with max. 512 MB	MMC-Card with max. 512 MB	MMC-Card with max. 512 MB	MMC-Card with max. 512 MB
Hardware configuration				
Racks, max.	-	1	1	1
Modules per rack, max.	-	4	4	4
Number of integrated DP master	-	-	-	-
Number of DP master via CP	-	4	4	4
Operable function modules	-	4	4	4
Operable communication modules PtP	-	4	4	4
Operable communication modules LAN	-	-	-	-

CPU CPU STEP7 programmable					
112-4BH02	114-6BJ52	115-6BL03			
114-6BJ02	114-6BJ53	115-6BL04			
114-6BJ03	114-6BJ54				
114-6BJ04	115-6BL02				

Order number	112-4BH02	114-6BJ02	114-6BJ03	114-6BJ04
Command processing times				
Bit instructions, min.	0.25 µs	0.25 µs	0.25 µs	0.25 µs
Word instruction, min.	1.2 µs	1.2 µs	1.2 µs	1.2 µs
Double integer arithmetic, min.	2.6 µs	2.6 µs	2.6 µs	2.6 µs
Floating-point arithmetic, min.	50 µs	50 µs	50 µs	50 µs
Timers/Counters and their retentive characteristics				
Number of S7 counters	256	256	256	256
S7 counter remanence	adjustable 0 up to 64	adjustable 0 up to 64	adjustable 0 up to 64	adjustable 0 up to 64
S7 counter remanence adjustable	C0 .. C7	C0 .. C7	C0 .. C7	C0 .. C7
Number of S7 times	256	256	256	256
S7 times remanence	adjustable 0 up to 128	adjustable 0 up to 128	adjustable 0 up to 128	adjustable 0 up to 128
S7 times remanence adjustable	not retentive	not retentive	not retentive	not retentive
Data range and retentive characteristic				
Number of flags	8192 Bit	8192 Bit	8192 Bit	8192 Bit
Bit memories retentive characteristic adjustable	adjustable 0 up to 256	adjustable 0 up to 256	adjustable 0 up to 256	adjustable 0 up to 256
Bit memories retentive characteristic preset	MB0 .. MB15	MB0 .. MB15	MB0 .. MB15	MB0 .. MB15
Number of data blocks	2047	2047	2047	2047
Max. data blocks size	16 KB	16 KB	16 KB	16 KB
Number range DBs	1 ... 2047	1 ... 2047	1 ... 2047	1 ... 2047
Max. local data size per execution level	1024 Byte	1024 Byte	1024 Byte	1024 Byte
Max. local data size per block	1024 Byte	1024 Byte	1024 Byte	1024 Byte
Blocks				
Number of OBs	14	14	14	14
Maximum OB size	16 KB	16 KB	16 KB	16 KB
Total number DBs, FBs, FCs	-	-	-	-
Number of FBs	1024	1024	1024	1024
Maximum FB size	16 KB	16 KB	16 KB	16 KB
Number range FBs	0 ... 1023	0 ... 1023	0 ... 1023	0 ... 1023
Number of FCs	1024	1024	1024	1024
Maximum FC size	16 KB	16 KB	16 KB	16 KB
Number range FC2	0 ... 1023	0 ... 1023	0 ... 1023	0 ... 1023
Maximum nesting depth per priority class	8	8	8	8
Maximum nesting depth additional within an error OB	1	1	1	1
Time				
Real-time clock buffered	✓	✓	✓	✓
Clock buffered period (min.)	30 d	30 d	30 d	30 d
Type of buffering	-	-	-	-
Load time for 50% buffering period	20 h	20 h	20 h	20 h
Load time for 100% buffering period	48 h	48 h	48 h	48 h
Accuracy (max. deviation per day)	10 s	10 s	10 s	10 s
Number of operating hours counter	8	8	8	8
Clock synchronization	-	-	-	-
Synchronization via MPI	-	-	-	-

CPU CPU STEP7 programmable				
112-4BH02	114-6BJ52	115-6BL03		
114-6BJ02	114-6BJ53	115-6BL04		
114-6BJ03	114-6BJ54			
114-6BJ04	115-6BL02			

Order number	112-4BH02	114-6BJ02	114-6BJ03	114-6BJ04
Synchronization via Ethernet (NTP)	-	-	-	-
Address areas (I/O)				
Input I/O address area	1024 Byte	1024 Byte	1024 Byte	1024 Byte
Output I/O address area	1024 Byte	1024 Byte	1024 Byte	1024 Byte
Process image adjustable	-	-	-	-
Input process image preset	128 Byte	128 Byte	128 Byte	128 Byte
Output process image preset	128 Byte	128 Byte	128 Byte	128 Byte
Input process image maximal	128 Byte	128 Byte	128 Byte	128 Byte
Output process image maximal	128 Byte	128 Byte	128 Byte	128 Byte
Digital inputs	12	8192	8192	8192
Digital outputs	8	8192	8192	8192
Digital inputs central	12	148	148	148
Digital outputs central	8	136	136	136
Integrated digital inputs	8 (12)	16 (20)	16 (20)	16 (20)
Integrated digital outputs	8 (4)	8 (4)	8 (4)	8 (4)
Analog inputs	-	512	512	512
Analog outputs	-	512	512	512
Analog inputs, central	-	32	32	32
Analog outputs, central	-	16	16	16
Integrated analog inputs	-	-	-	-
Integrated analog outputs	-	-	-	-
Communication functions				
PG/OP channel	✓	✓	✓	✓
Global data communication	✓	✓	✓	✓
Number of GD circuits, max.	4	4	4	4
Size of GD packets, max.	22 Byte	22 Byte	22 Byte	22 Byte
S7 basic communication	✓	✓	✓	✓
S7 basic communication, user data per job	76 Byte	76 Byte	76 Byte	76 Byte
S7 communication	✓	✓	✓	✓
S7 communication as server	✓	✓	✓	✓
S7 communication as client	-	-	-	-
S7 communication, user data per job	160 Byte	160 Byte	160 Byte	160 Byte
Number of connections, max.	16	16	16	16
Functionality Sub-D interfaces				
Type	MP ² I	MP ² I	MP ² I	MP ² I
Type of interface	RS485	RS485	RS485	RS485
Connector	Sub-D, 9-pin, female	Sub-D, 9-pin, female	Sub-D, 9-pin, female	Sub-D, 9-pin, female
Electrically isolated	-	-	-	-
MPI	✓	✓	✓	✓
MP ² I (MPI/RS232)	✓	✓	✓	✓
Point-to-point interface	-	-	-	-

SLIO
100V
200V
300S
500S
HMI
Teleservice
StarterKits
Safety
Solutions
Software
Accessories
Appendix

CPU CPU STEP7 programmable					
112-4BH02	114-6BJ52	115-6BL03			
114-6BJ02	114-6BJ53	115-6BL04			
114-6BJ03	114-6BJ54				
114-6BJ04	115-6BL02				

Order number	112-4BH02	114-6BJ02	114-6BJ03	114-6BJ04
Functionality MPI				
Number of connections, max.	16	16	16	16
PG/OP channel	✓	✓	✓	✓
Routing	-	-	-	-
Global data communication	✓	✓	✓	✓
S7 basic communication	✓	✓	✓	✓
S7 communication	✓	✓	✓	✓
S7 communication as server	✓	✓	✓	✓
S7 communication as client	-	-	-	-
Transmission speed, min.	19.2 kbit/s	19.2 kbit/s	19.2 kbit/s	19.2 kbit/s
Transmission speed, max.	187.5 kbit/s	187.5 kbit/s	187.5 kbit/s	187.5 kbit/s
Housing				
Material	PPE / PA 6.6	PPE / PA 6.6	PPE / PA 6.6	PPE / PA 6.6
Mounting	Profile rail 35 mm	Profile rail 35 mm	Profile rail 35 mm	Profile rail 35 mm
Mechanical data				
Dimensions (WxHxD)	101.6 mm x 76 mm x 48 mm	152.4 mm x 76 mm x 48 mm	152.4 mm x 76 mm x 48 mm	152.4 mm x 76 mm x 48 mm
Weight	219 g	266 g	266 g	266 g
Environmental conditions				
Operating temperature	0 °C to 60 °C	0 °C to 60 °C	0 °C to 60 °C	0 °C to 60 °C
Storage temperature	-25 °C to 70 °C	-25 °C to 70 °C	-25 °C to 70 °C	-25 °C to 70 °C
Certifications				
UL508 certification	yes	yes	yes	yes

Connections, Interfaces

CPUs | CPUs STEP7 programmable

112-4BH02	114-6BJ52	115-6BL03			
114-6BJ02	114-6BJ53	115-6BL04			
114-6BJ03	114-6BJ54				
114-6BJ04	115-6BL02				

112-4BH02

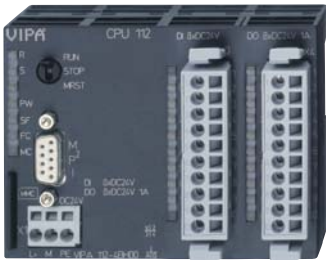

MP1

- ① reserved
- ② M24V
- ③ RxD/TxD-P (line B)
- ④ RTS
- ⑤ M5V
- ⑥ P5V
- ⑦ P24V
- ⑧ RxD/TxD-N (line A)
- ⑨ n.c.

X1

- ① L+
- ② M
- ③ PE

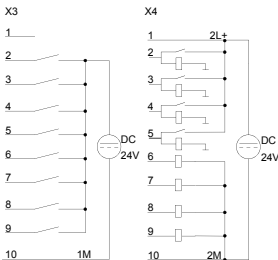

114-6BJ02



MP1

- ① reserved
- ② M24V
- ③ RxD/TxD-P (line B)
- ④ RTS
- ⑤ M5V
- ⑥ P5V
- ⑦ P24V
- ⑧ RxD/TxD-N (line A)
- ⑨ n.c.

X1

- ① L+
- ② M
- ③ PE

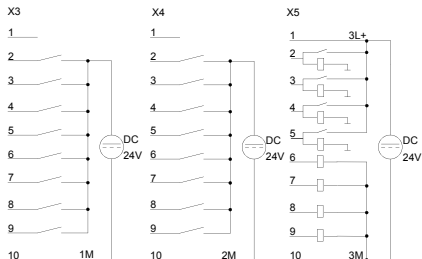

114-6BJ03



MP1

- ① reserved
- ② M24V
- ③ RxD/TxD-P (line B)
- ④ RTS
- ⑤ M5V
- ⑥ P5V
- ⑦ P24V
- ⑧ RxD/TxD-N (line A)
- ⑨ n.c.

X1

- ① L+
- ② M
- ③ PE

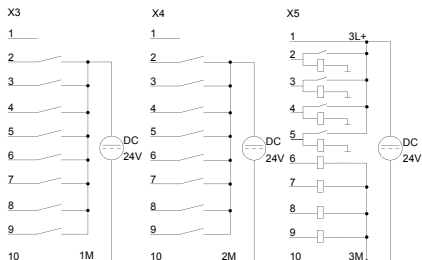

114-6BJ04



MP1

- ① reserved
- ② M24V
- ③ RxD/TxD-P (line B)
- ④ RTS
- ⑤ M5V
- ⑥ P5V
- ⑦ P24V
- ⑧ RxD/TxD-N (line A)
- ⑨ n.c.

X1

- ① L+
- ② M
- ③ PE

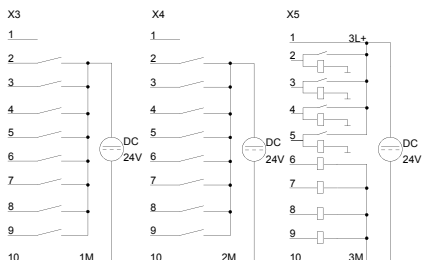

CPUs STEP7 programmable

CPUs CPUs STEP7 programmable					
112-4BH02	114-6BJ52	115-6BL03			
114-6BJ02	114-6BJ53	115-6BL04			
114-6BJ03	114-6BJ54				
114-6BJ04	115-6BL02				

Order number	114-6BJ52	114-6BJ53	114-6BJ54	115-6BL02
Figure				
Type	CPU 114R	CPU 114R	CPU 114R	CPU 115
General information				
Note	-	-	-	-
Features	<ul style="list-style-type: none"> ▶ 16 inputs ▶ 8 relay outputs ▶ AC 230 V/ DC 30 V ▶ 16 kB work memory, 24 kB load memory 	<ul style="list-style-type: none"> ▶ 16 inputs ▶ 8 relay outputs ▶ AC 230 V/ DC 30 V ▶ 24 kB work memory, 32 kB load memory 	<ul style="list-style-type: none"> ▶ 16 inputs ▶ 8 relay outputs ▶ AC 230 V/ DC 30 V ▶ 32 kB work memory, 40 kB load memory 	<ul style="list-style-type: none"> ▶ 16 (20) inputs ▶ 16 (12) outputs ▶ from which are 2 PWM 50 kHz outputs ▶ 16 kB work memory, 24 kB load memory
Technical data power supply				
Power supply (rated value)	DC 24 V	DC 24 V	DC 24 V	DC 24 V
Power supply (permitted range)	DC 20.4...28.8 V	DC 20.4...28.8 V	DC 20.4...28.8 V	DC 20.4...28.8 V
Reverse polarity protection	✓	✓	✓	✓
Current consumption (no-load operation)	150 mA	150 mA	150 mA	90 mA
Current consumption (rated value)	1 A	1 A	1 A	1 A
Inrush current	58 A	58 A	58 A	58 A
I _{Δt}	0.38 A ² s	0.38 A ² s	0.38 A ² s	0.38 A ² s
Max. current drain at backplane bus	0.8 μA	0.8 μA	0.8 μA	0.8 A
Power loss	7 W	7 W	7 W	8.5 W
Reverse polarity protection	✓	✓	✓	✓
Technical data digital inputs				
Number of inputs	16	16	16	16 (20)
Cable length, shielded	1000 m	1000 m	1000 m	1000 m
Cable length, unshielded	600 m	600 m	600 m	600 m
Rated load voltage	DC 24 V	DC 24 V	DC 24 V	DC 24 V
Reverse polarity protection of rated load voltage	✓	✓	✓	✓
Current consumption from load voltage L+ (without load)	-	-	-	-
Rated value	DC 24 V	DC 24 V	DC 24 V	DC 24 V
Input voltage for signal "0"	DC 0...5 V	DC 0...5 V	DC 0...5 V	DC 0...5 V
Input voltage for signal "1"	DC 15...28.8 V	DC 15...28.8 V	DC 15...28.8 V	DC 15...28.8 V
Input current for signal "1"	7 mA	7 mA	7 mA	7 mA
Connection of Two-Wire-BEROs possible	✓	✓	✓	✓
Max. permissible BERO quiescent current	1.5 mA	1.5 mA	1.5 mA	1.5 mA
Input delay of "0" to "1"	3 ms	3 ms	3 ms	3 ms
Input delay of "1" to "0"	3 ms	3 ms	3 ms	3 ms
Input characteristic curve	IEC 61131-2, type 1	IEC 61131-2, type 1	IEC 61131-2, type 1	IEC 61131-2, type 1
Initial data size	3 Byte	3 Byte	3 Byte	3 Byte

CPUs CPUs STEP7 programmable					
112-4BH02	114-6BJ52	115-6BL03			
114-6BJ02	114-6BJ53	115-6BL04			
114-6BJ03	114-6BJ54				
114-6BJ04	115-6BL02				

Order number	114-6BJ52	114-6BJ53	114-6BJ54	115-6BL02
Technical data digital outputs				
Number of outputs	8	8	8	16 (12)
Cable length, shielded	1000 m	1000 m	1000 m	1000 m
Cable length, unshielded	600 m	600 m	600 m	600 m
Rated load voltage	DC 30 V/ AC 230 V	DC 30 V/ AC 230 V	DC 30 V/ AC 230 V	DC 24 V
Reverse polarity protection of rated load voltage	-	-	-	-
Current consumption from load voltage L+ (without load)	-	-	-	50 mA
Total current per group, horizontal configuration, 40°C	8 A	8 A	8 A	4 A
Total current per group, horizontal configuration, 60°C	8 A	8 A	8 A	4 A
Total current per group, vertical configuration	8 A	8 A	8 A	4 A
Output voltage signal "1" at min. current	-	-	-	L+ (-125 mV)
Output voltage signal "1" at max. current	-	-	-	L+ (-0.8 V)
Output current at signal "1", rated value	5 A	5 A	5 A	0.5 A
Output delay of "0" to "1"	10 ms	10 ms	10 ms	max. 100 µs
Output delay of "1" to "0"	5 ms	5 ms	5 ms	max. 350 µs
Minimum load current	-	-	-	-
Lamp load	-	-	-	5 W
Switching frequency with resistive load	max. 10 Hz	max. 10 Hz	max. 10 Hz	max. 1000 Hz
Switching frequency with inductive load	-	-	-	max. 0.5 Hz
Switching frequency on lamp load	-	-	-	max. 10 Hz
Internal limitation of inductive shut-off voltage	-	-	-	L+ (-52 V)
Short-circuit protection of output	-	-	-	yes, electronic
Trigger level	-	-	-	1 A
Output data size	3 Byte	3 Byte	3 Byte	3 Byte
Technical data counters				
Number of counters	4	4	4	4
Counter width	32 Bit	32 Bit	32 Bit	32 Bit
Maximum input frequency	30 kHz	30 kHz	30 kHz	30 kHz
Maximum count frequency	30 kHz	30 kHz	30 kHz	30 kHz
Mode incremental encoder	✓	✓	✓	✓
Mode pulse / direction	✓	✓	✓	✓
Mode pulse	✓	✓	✓	✓
Mode frequency counter	-	-	-	-
Mode period measurement	-	-	-	-
Gate input available	✓	✓	✓	✓
Latch input available	-	-	-	-
Reset input available	-	-	-	-
Counter output available	-	-	-	-

SLIO
100V
200V
300S
500S
HMI
Teleservice
StarterKits
Safety
Solutions
Software
Accessories
Appendix

CPUs CPUs STEP7 programmable					
112-4BH02	114-6BJ52	115-6BL03			
114-6BJ02	114-6BJ53	115-6BL04			
114-6BJ03	114-6BJ54				
114-6BJ04	115-6BL02				

Order number	114-6BJ52	114-6BJ53	114-6BJ54	115-6BL02
Status information, alarms, diagnostics				
Status display	yes	yes	yes	yes
Interrupts	yes	yes	yes	yes
Process alarm	yes	yes	yes	yes
Diagnostic interrupt	yes	yes	yes	yes
Diagnostic functions	no	no	no	no
Diagnostics information read-out	possible	possible	possible	possible
Supply voltage display	green LED	green LED	green LED	green LED
Group error display	red SF LED	red SF LED	red SF LED	red SF LED
Channel error display	none	none	none	none
Isolation				
Between channels of groups to	8	8	8	8
Between channels and backplane bus	✓	✓	✓	✓
Insulation tested with	DC 500 V	DC 500 V	DC 500 V	DC 500 V
PWM data				
PWM channels	-	-	-	2
PWM time basis	-	-	-	-
Period length	-	-	-	-
Minimum pulse width	-	-	-	-
PtP communication	-	-	-	-
Load and working memory				
Load memory, integrated	24 KB	32 KB	40 KB	24 KB
Load memory, maximum	24 KB	32 KB	40 KB	24 KB
Work memory, integrated	16 KB	24 KB	32 KB	16 KB
Work memory, maximal	16 KB	24 KB	32 KB	16 KB
Memory divided in 50% program / 50% data	-	-	-	-
Memory card slot	MMC-Card with max. 512 MB	MMC-Card with max. 512 MB	MMC-Card with max. 512 MB	MMC-Card with max. 512 MB
Hardware configuration				
Racks, max.	1	1	1	1
Modules per rack, max.	4	4	4	4
Number of integrated DP master	-	-	-	-
Number of DP master via CP	4	4	4	4
Operable function modules	4	4	4	4
Operable communication modules PtP	4	4	4	4
Operable communication modules LAN	-	-	-	-
Command processing times				
Bit instructions, min.	0.25 µs	0.25 µs	0.25 µs	0.25 µs
Word instruction, min.	1.2 µs	1.2 µs	1.2 µs	1.2 µs
Double integer arithmetic, min.	2.6 µs	2.6 µs	2.6 µs	2.6 µs
Floating-point arithmetic, min.	50 µs	50 µs	50 µs	50 µs

SLIO
100V
200V
300S
500S
HMI
Teleservice
StarterKits
Safety
Solutions
Software
Accessories
Appendix

CPUs CPUs STEP7 programmable					
112-4BH02	114-6BJ52	115-6BL03			
114-6BJ02	114-6BJ53	115-6BL04			
114-6BJ03	114-6BJ54				
114-6BJ04	115-6BL02				

Order number	114-6BJ52	114-6BJ53	114-6BJ54	115-6BL02
Timers/Counters and their retentive characteristics				
Number of S7 counters	256	256	256	256
S7 counter remanence	adjustable 0 up to 64	adjustable 0 up to 64	adjustable 0 up to 64	adjustable 0 up to 64
S7 counter remanence adjustable	C0 .. C7	C0 .. C7	C0 .. C7	C0 .. C7
Number of S7 times	256	256	256	256
S7 times remanence	adjustable 0 up to 128	adjustable 0 up to 128	adjustable 0 up to 128	adjustable 0 up to 128
S7 times remanence adjustable	not retentive	not retentive	not retentive	not retentive
Data range and retentive characteristic				
Number of flags	8192 Bit	8192 Bit	8192 Bit	8192 Bit
Bit memories retentive characteristic adjustable	adjustable 0 up to 256	adjustable 0 up to 256	adjustable 0 up to 256	adjustable 0 up to 256
Bit memories retentive characteristic preset	MB0 .. MB15	MB0 .. MB15	MB0 .. MB15	MB0 .. MB15
Number of data blocks	2047	2047	2047	2047
Max. data blocks size	16 KB	16 KB	16 KB	16 KB
Number range DBs	1 ... 2047	1 ... 2047	1 ... 2047	1 ... 2047
Max. local data size per execution level	1024 Byte	1024 Byte	1024 Byte	1024 Byte
Max. local data size per block	1024 Byte	1024 Byte	1024 Byte	1024 Byte
Blocks				
Number of OBs	14	14	14	14
Maximum OB size	16 KB	16 KB	16 KB	16 KB
Totalnumber DBs, FBs, FCs	-	-	-	-
Number of FBs	1024	1024	1024	1024
Maximum FB size	16 KB	16 KB	16 KB	16 KB
Number range FBs	0 ... 1023	0 ... 1023	0 ... 1023	0 ... 1023
Number of FCs	1024	1024	1024	1024
Maximum FC size	16 KB	16 KB	16 KB	16 KB
Number range FC2	0 ... 1023	0 ... 1023	0 ... 1023	0 ... 1023
Maximum nesting depth per priority class	8	8	8	8
Maximum nesting depth additional within an error OB	1	1	1	1
Time				
Real-time clock buffered	✓	✓	✓	✓
Clock buffered period (min.)	30 d	30 d	30 d	30 d
Type of buffering	-	-	-	-
Load time for 50% buffering period	20 h	20 h	20 h	20 h
Load time for 100% buffering period	48 h	48 h	48 h	48 h
Accuracy (max. deviation per day)	10 s	10 s	10 s	10 s
Number of operating hours counter	8	8	8	8
Clock synchronization	-	-	-	-
Synchronization via MPI	-	-	-	-
Synchronization via Ethernet (NTP)	-	-	-	-

SLIO
100V
200V
300S
500S
HMI
Teleservice
StarterKits
Safety
Solutions
Software
Accessories
Appendix

CPU CPU STEP7 programmable					
112-4BH02	114-6BJ52	115-6BL03			
114-6BJ02	114-6BJ53	115-6BL04			
114-6BJ03	114-6BJ54				
114-6BJ04	115-6BL02				

Order number	114-6BJ52	114-6BJ53	114-6BJ54	115-6BL02
Address areas (I/O)				
Input I/O address area	1024 Byte	1024 Byte	1024 Byte	1024 Byte
Output I/O address area	1024 Byte	1024 Byte	1024 Byte	1024 Byte
Process image adjustable	-	-	-	-
Input process image preset	128 Byte	128 Byte	128 Byte	128 Byte
Output process image preset	128 Byte	128 Byte	128 Byte	128 Byte
Input process image maximal	128 Byte	128 Byte	128 Byte	128 Byte
Output process image maximal	128 Byte	128 Byte	128 Byte	128 Byte
Digital inputs	8192	8192	8192	8192
Digital outputs	8192	8192	8192	8192
Digital inputs central	144	144	144	148
Digital outputs central	136	136	136	144
Integrated digital inputs	16	16	16	16 (20)
Integrated digital outputs	8	8	8	16 (12)
Analog inputs	512	512	512	512
Analog outputs	512	512	512	512
Analog inputs, central	32	32	32	32
Analog outputs, central	16	16	16	16
Integrated analog inputs	-	-	-	-
Integrated analog outputs	-	-	-	-
Communication functions				
PG/OP channel	✓	✓	✓	✓
Global data communication	✓	✓	✓	✓
Number of GD circuits, max.	4	4	4	4
Size of GD packets, max.	22 Byte	22 Byte	22 Byte	22 Byte
S7 basic communication	✓	✓	✓	✓
S7 basic communication, user data per job	76 Byte	76 Byte	76 Byte	76 Byte
S7 communication	✓	✓	✓	✓
S7 communication as server	✓	✓	✓	✓
S7 communication as client	-	-	-	-
S7 communication, user data per job	160 Byte	160 Byte	160 Byte	160 Byte
Number of connections, max.	16	16	16	16
Functionality Sub-D interfaces				
Type	MP ² I	MP ² I	MP ² I	MP ² I
Type of interface	RS485	RS485	RS485	RS485
Connector	Sub-D, 9-pin, female	Sub-D, 9-pin, female	Sub-D, 9-pin, female	Sub-D, 9-pin, female
Electrically isolated	-	-	-	-
MPI	✓	✓	✓	✓
MP ² I (MPI/RS232)	✓	✓	✓	✓
Point-to-point interface	-	-	-	-

SLIO
100V
200V
300S
500S
HMI
Teleservice
StarterKits
Safety
Solutions
Software
Accessories
Appendix

CPUs CPUs STEP7 programmable					
112-4BH02	114-6BJ52	115-6BL03			
114-6BJ02	114-6BJ53	115-6BL04			
114-6BJ03	114-6BJ54				
114-6BJ04	115-6BL02				

Order number	114-6BJ52	114-6BJ53	114-6BJ54	115-6BL02
Functionality MPI				
Number of connections, max.	16	16	16	16
PG/OP channel	✓	✓	✓	✓
Routing	-	-	-	-
Global data communication	✓	✓	✓	✓
S7 basic communication	✓	✓	✓	✓
S7 communication	✓	✓	✓	✓
S7 communication as server	✓	✓	✓	✓
S7 communication as client	-	-	-	-
Transmission speed, min.	19.2 kbit/s	19.2 kbit/s	19.2 kbit/s	19.2 kbit/s
Transmission speed, max.	187.5 kbit/s	187.5 kbit/s	187.5 kbit/s	187.5 kbit/s
Housing				
Material	PPE / PA 6.6	PPE / PA 6.6	PPE / PA 6.6	PPE / PA 6.6
Mounting	Profile rail 35 mm	Profile rail 35 mm	Profile rail 35 mm	Profile rail 35 mm
Mechanical data				
Dimensions (WxHxD)	152.4 mm x 76 mm x 48 mm	152.4 mm x 76 mm x 48 mm	152.4 mm x 76 mm x 48 mm	152.4 mm x 76 mm x 48 mm
Weight	280 g	280 g	280 g	292 g
Environmental conditions				
Operating temperature	0 °C to 60 °C	0 °C to 60 °C	0 °C to 60 °C	0 °C to 60 °C
Storage temperature	-25 °C to 70 °C	-25 °C to 70 °C	-25 °C to 70 °C	-25 °C to 70 °C
Certifications				
UL508 certification	yes	yes	yes	yes

Connections, Interfaces

CPU | CPUs STEP7 programmable

112-4BH02	114-6BJ52	115-6BL03			
114-6BJ02	114-6BJ53	115-6BL04			
114-6BJ03	114-6BJ54				
114-6BJ04	115-6BL02				

114-6BJ52

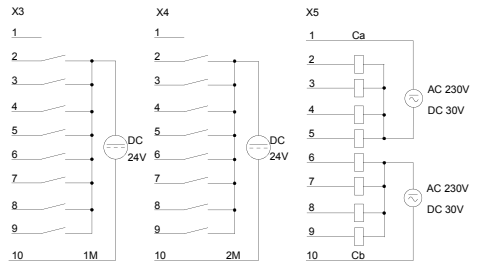
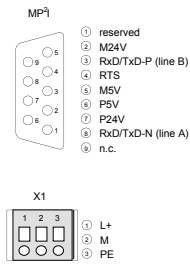
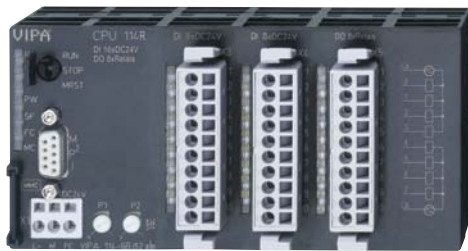

114-6BJ53

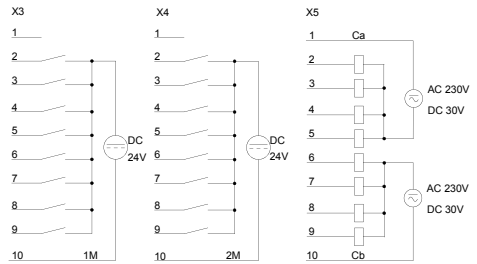
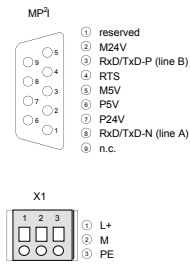

114-6BJ54

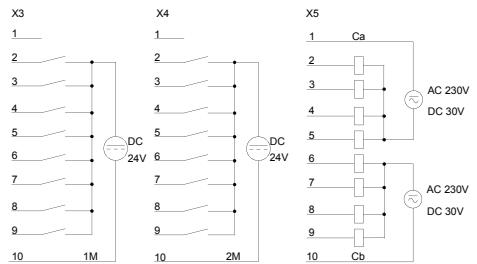
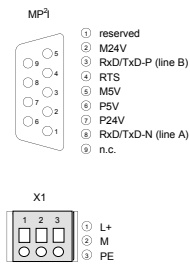
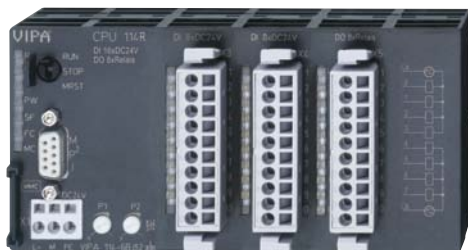

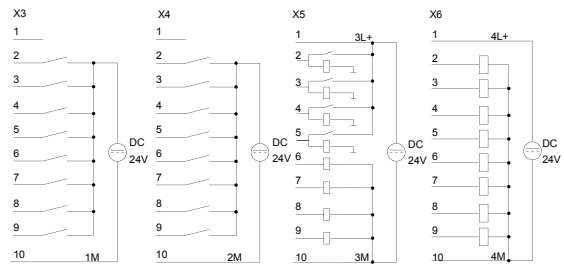
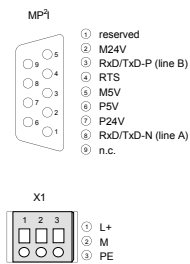
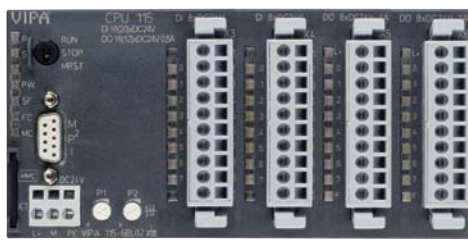

115-6BL02



CPUs STEP7 programmable

CPUs CPUs STEP7 programmable					
112-4BH02	114-6BJ52	115-6BL03			
114-6BJ02	114-6BJ53	115-6BL04			
114-6BJ03	114-6BJ54				
114-6BJ04	115-6BL02				

Order number	115-6BL03	115-6BL04		
Figure				
Type	CPU 115	CPU 115		
General information				
Note	-	-		
Features	<ul style="list-style-type: none"> ▶ 16 (20) inputs ▶ 16 (12) outputs ▶ from which are 2 PWM 50 kHz outputs ▶ 24 kB work memory, 32 kB load memory 	<ul style="list-style-type: none"> ▶ 16 (20) inputs ▶ 16 (12) outputs ▶ from which are 2 PWM 50 kHz outputs ▶ 32 kB work memory, 40 kB load memory 		
Technical data power supply				
Power supply (rated value)	DC 24 V	DC 24 V		
Power supply (permitted range)	DC 20.4...28.8 V	DC 20.4...28.8 V		
Reverse polarity protection	✓	✓		
Current consumption (no-load operation)	90 mA	90 mA		
Current consumption (rated value)	1 A	1 A		
Inrush current	58 A	58 A		
I _{Δt}	0.38 A ² s	0.38 A ² s		
Max. current drain at backplane bus	0.8 A	0.8 A		
Power loss	8.5 W	8.5 W		
Reverse polarity protection	✓	✓		
Technical data digital inputs				
Number of inputs	16 (20)	16 (20)		
Cable length, shielded	1000 m	1000 m		
Cable length, unshielded	600 m	600 m		
Rated load voltage	DC 24 V	DC 24 V		
Reverse polarity protection of rated load voltage	✓	✓		
Current consumption from load voltage L+ (without load)	-	-		
Rated value	DC 24 V	DC 24 V		
Input voltage for signal "0"	DC 0...5 V	DC 0...5 V		
Input voltage for signal "1"	DC 15...28.8 V	DC 15...28.8 V		
Input current for signal "1"	7 mA	7 mA		
Connection of Two-Wire-BEROs possible	✓	✓		
Max. permissible BERO quiescent current	1.5 mA	1.5 mA		
Input delay of "0" to "1"	3 ms	3 ms		
Input delay of "1" to "0"	3 ms	3 ms		
Input characteristic curve	IEC 61131-2, type 1	IEC 61131-2, type 1		
Initial data size	3 Byte	3 Byte		

CPUs CPUs STEP7 programmable					
112-4BH02	114-6BJ52	115-6BL03 115-6BL04			
114-6BJ02	114-6BJ53				
114-6BJ03	114-6BJ54				
114-6BJ04	115-6BL02				

Order number	115-6BL03	115-6BL04		
Technical data digital outputs				
Number of outputs	16 (12)	16 (12)		
Cable length, shielded	1000 m	1000 m		
Cable length, unshielded	600 m	600 m		
Rated load voltage	DC 24 V	DC 24 V		
Reverse polarity protection of rated load voltage	-	-		
Current consumption from load voltage L+ (without load)	50 mA	50 mA		
Total current per group, horizontal configuration, 40°C	4 A	4 A		
Total current per group, horizontal configuration, 60°C	4 A	4 A		
Total current per group, vertical configuration	4 A	4 A		
Output voltage signal "1" at min. current	L+ (-125 mV)	L+ (-125 mV)		
Output voltage signal "1" at max. current	L+ (-0.8 V)	L+ (-0.8 V)		
Output current at signal "1", rated value	0.5 A	0.5 A		
Output delay of "0" to "1"	max. 100 µs	max. 100 µs		
Output delay of "1" to "0"	max. 350 µs	max. 350 µs		
Minimum load current	-	-		
Lamp load	5 W	5 W		
Switching frequency with resistive load	max. 1000 Hz	max. 1000 Hz		
Switching frequency with inductive load	max. 0.5 Hz	max. 0.5 Hz		
Switching frequency on lamp load	max. 10 Hz	max. 10 Hz		
Internal limitation of inductive shut-off voltage	L+ (-52 V)	L+ (-52 V)		
Short-circuit protection of output	yes, electronic	yes, electronic		
Trigger level	1 A	1 A		
Output data size	3 Byte	3 Byte		
Technical data counters				
Number of counters	4	4		
Counter width	32 Bit	32 Bit		
Maximum input frequency	30 kHz	30 kHz		
Maximum count frequency	30 kHz	30 kHz		
Mode incremental encoder	✓	✓		
Mode pulse / direction	✓	✓		
Mode pulse	✓	✓		
Mode frequency counter	-	-		
Mode period measurement	-	-		
Gate input available	✓	✓		
Latch input available	-	-		
Reset input available	-	-		
Counter output available	-	-		

SLIO
100V
200V
300S
500S
HMI
Teleservice
StarterKits
Safety
Solutions
Software
Accessories
Appendix

CPUs CPUs STEP7 programmable						
112-4BH02	114-6BJ52	115-6BL03				
114-6BJ02	114-6BJ53	115-6BL04				
114-6BJ03	114-6BJ54					
114-6BJ04	115-6BL02					

Order number	115-6BL03	115-6BL04		
Status information, alarms, diagnostics				
Status display	yes	yes		
Interrupts	yes	yes		
Process alarm	yes	yes		
Diagnostic interrupt	yes	yes		
Diagnostic functions	no	no		
Diagnostics information read-out	possible	possible		
Supply voltage display	green LED	green LED		
Group error display	red SF LED	red SF LED		
Channel error display	none	none		
Isolation				
Between channels of groups to	8	8		
Between channels and backplane bus	✓	✓		
Insulation tested with	DC 500 V	DC 500 V		
PWM data				
PWM channels	2	2		
PWM time basis	-	-		
Period length	-	-		
Minimum pulse width	-	-		
PtP communication	-	-		
Load and working memory				
Load memory, integrated	32 KB	40 KB		
Load memory, maximum	32 KB	40 KB		
Work memory, integrated	24 KB	32 KB		
Work memory, maximal	24 KB	32 KB		
Memory divided in 50% program / 50% data	-	-		
Memory card slot	MMC-Card with max. 512 MB	MMC-Card with max. 512 MB		
Hardware configuration				
Racks, max.	1	1		
Modules per rack, max.	4	4		
Number of integrated DP master	-	-		
Number of DP master via CP	4	4		
Operable function modules	4	4		
Operable communication modules PtP	4	4		
Operable communication modules LAN	-	-		
Command processing times				
Bit instructions, min.	0.25 µs	0.25 µs		
Word instruction, min.	1.2 µs	1.2 µs		
Double integer arithmetic, min.	2.6 µs	2.6 µs		
Floating-point arithmetic, min.	50 µs	50 µs		

CPUs CPUs STEP7 programmable						
112-4BH02	114-6BJ52	115-6BL03				
114-6BJ02	114-6BJ53	115-6BL04				
114-6BJ03	114-6BJ54					
114-6BJ04	115-6BL02					

Order number	115-6BL03	115-6BL04		
Timers/Counters and their retentive characteristics				
Number of S7 counters	256	256		
S7 counter remanence	adjustable 0 up to 64	adjustable 0 up to 64		
S7 counter remanence adjustable	C0 .. C7	C0 .. C7		
Number of S7 times	256	256		
S7 times remanence	adjustable 0 up to 128	adjustable 0 up to 128		
S7 times remanence adjustable	not retentive	not retentive		
Data range and retentive characteristic				
Number of flags	8192 Bit	8192 Bit		
Bit memories retentive characteristic adjustable	adjustable 0 up to 256	adjustable 0 up to 256		
Bit memories retentive characteristic preset	MB0 .. MB15	MB0 .. MB15		
Number of data blocks	2047	2047		
Max. data blocks size	16 KB	16 KB		
Number range DBs	1 ... 2047	1 ... 2047		
Max. local data size per execution level	1024 Byte	1024 Byte		
Max. local data size per block	1024 Byte	1024 Byte		
Blocks				
Number of OBs	14	14		
Maximum OB size	16 KB	16 KB		
Totalnumber DBs, FBs, FCs	-	-		
Number of FBs	1024	1024		
Maximum FB size	16 KB	16 KB		
Number range FBs	0 ... 1023	0 ... 1023		
Number of FCs	1024	1024		
Maximum FC size	16 KB	16 KB		
Number range FC2	0 ... 1023	0 ... 1023		
Maximum nesting depth per priority class	8	8		
Maximum nesting depth additional within an error OB	1	1		
Time				
Real-time clock buffered	✓	✓		
Clock buffered period (min.)	30 d	30 d		
Type of buffering	-	-		
Load time for 50% buffering period	20 h	20 h		
Load time for 100% buffering period	48 h	48 h		
Accuracy (max. deviation per day)	10 s	10 s		
Number of operating hours counter	8	8		
Clock synchronization	-	-		
Synchronization via MPI	-	-		
Synchronization via Ethernet (NTP)	-	-		

SLIO
100V
200V
300S
500S
HMI
Teleservice
StarterKits
Safety
Solutions
Software
Accessories
Appendix

CPUs CPUs STEP7 programmable						
112-4BH02	114-6BJ52	115-6BL03 115-6BL04				
114-6BJ02	114-6BJ53					
114-6BJ03	114-6BJ54					
114-6BJ04	115-6BL02					

Order number	115-6BL03	115-6BL04		
Address areas (I/O)				
Input I/O address area	1024 Byte	1024 Byte		
Output I/O address area	1024 Byte	1024 Byte		
Process image adjustable	-	-		
Input process image preset	128 Byte	128 Byte		
Output process image preset	128 Byte	128 Byte		
Input process image maximal	128 Byte	128 Byte		
Output process image maximal	128 Byte	128 Byte		
Digital inputs	8192	8192		
Digital outputs	8192	8192		
Digital inputs central	148	148		
Digital outputs central	144	144		
Integrated digital inputs	16 (20)	16 (20)		
Integrated digital outputs	16 (12)	16 (12)		
Analog inputs	512	512		
Analog outputs	512	512		
Analog inputs, central	32	32		
Analog outputs, central	16	16		
Integrated analog inputs	-	-		
Integrated analog outputs	-	-		
Communication functions				
PG/OP channel	✓	✓		
Global data communication	✓	✓		
Number of GD circuits, max.	4	4		
Size of GD packets, max.	22 Byte	22 Byte		
S7 basic communication	✓	✓		
S7 basic communication, user data per job	76 Byte	76 Byte		
S7 communication	✓	✓		
S7 communication as server	✓	✓		
S7 communication as client	-	-		
S7 communication, user data per job	160 Byte	160 Byte		
Number of connections, max.	16	16		
Functionality Sub-D interfaces				
Type	MP ² I	MP ² I		
Type of interface	RS485	RS485		
Connector	Sub-D, 9-pin, female	Sub-D, 9-pin, female		
Electrically isolated	-	-		
MPI	✓	✓		
MP ² I (MPI/RS232)	✓	✓		
Point-to-point interface	-	-		

CPUs CPUs STEP7 programmable						
112-4BH02	114-6BJ52	115-6BL03				
114-6BJ02	114-6BJ53	115-6BL04				
114-6BJ03	114-6BJ54					
114-6BJ04	115-6BL02					

Order number	115-6BL03	115-6BL04		
Functionality MPI				
Number of connections, max.	16	16		
PG/OP channel	✓	✓		
Routing	-	-		
Global data communication	✓	✓		
S7 basic communication	✓	✓		
S7 communication	✓	✓		
S7 communication as server	✓	✓		
S7 communication as client	-	-		
Transmission speed, min.	19.2 kbit/s	19.2 kbit/s		
Transmission speed, max.	187.5 kbit/s	187.5 kbit/s		
Housing				
Material	PPE / PA 6.6	PPE / PA 6.6		
Mounting	Profile rail 35 mm	Profile rail 35 mm		
Mechanical data				
Dimensions (WxHxD)	152.4 mm x 76 mm x 48 mm	152.4 mm x 76 mm x 48 mm		
Weight	292 g	292 g		
Environmental conditions				
Operating temperature	0 °C to 60 °C	0 °C to 60 °C		
Storage temperature	-25 °C to 70 °C	-25 °C to 70 °C		
Certifications				
UL508 certification	yes	yes		

Connections, Interfaces

CPUs | CPUs STEP7 programmable

112-4BH02	114-6BJ52	115-6BL03 115-6BL04			
114-6BJ02	114-6BJ53				
114-6BJ03	114-6BJ54				
114-6BJ04	115-6BL02				

115-6BL03

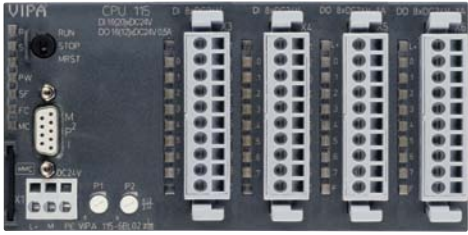

MP1

- ① reserved
- ② M24V
- ③ RxD/TxD-P (line B)
- ④ RTS
- ⑤ M5V
- ⑥ P5V
- ⑦ P24V
- ⑧ RxD/TxD-N (line A)
- ⑨ n.c.

X1

- ① L+
- ② M
- ③ PE

X3

1
2
3
4
5
6
7
8
9
10

DC 24V

X4

1
2
3
4
5
6
7
8
9
10

DC 24V

X5

1
2
3
4
5
6
7
8
9
10

DC 24V

X6

1
2
3
4
5
6
7
8
9
10

DC 24V

115-6BL04

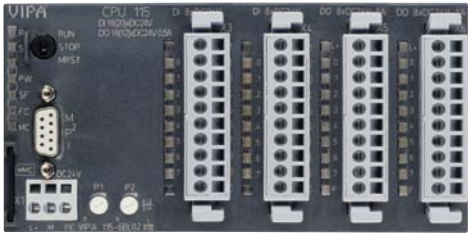

MP1

- ① reserved
- ② M24V
- ③ RxD/TxD-P (line B)
- ④ RTS
- ⑤ M5V
- ⑥ P5V
- ⑦ P24V
- ⑧ RxD/TxD-N (line A)
- ⑨ n.c.

X1

- ① L+
- ② M
- ③ PE

X3

1
2
3
4
5
6
7
8
9
10

DC 24V

X4

1
2
3
4
5
6
7
8
9
10

DC 24V

X5

1
2
3
4
5
6
7
8
9
10

DC 24V





X6

1
2
3
4
5
6
7
8
9
10

DC 24V

CPU | CPUs STEP7 programmable, PtP

CPU CPUs STEP7 programmable, PtP					
115-6BL12	115-6BL33				
115-6BL13	115-6BL34				
115-6BL14					
115-6BL32					

Order number	115-6BL12	115-6BL13	115-6BL14	115-6BL32
Figure				
Type	CPU 115SER	CPU 115SER	CPU 115SER	CPU 115SER
General information				
Note	-	-	-	-
Features	<ul style="list-style-type: none"> ▶ 16 (20) inputs ▶ 16 (12) outputs ▶ from which are 2 PWM 50 kHz outputs ▶ 16 kB work memory, 24 kB load memory ▶ RS232 interface 	<ul style="list-style-type: none"> ▶ 16 (20) inputs ▶ 16 (12) outputs ▶ from which are 2 PWM 50 kHz outputs ▶ 24 kB work memory, 32 kB load memory ▶ RS232 interface 	<ul style="list-style-type: none"> ▶ 16 (20) inputs ▶ 16 (12) outputs ▶ from which are 2 PWM 50 kHz outputs ▶ 32 kB work memory, 40 kB load memory ▶ RS232 interface 	<ul style="list-style-type: none"> ▶ 16 (20) inputs ▶ 16 (12) outputs ▶ from which are 2 PWM 50 kHz outputs ▶ 16 kB work memory, 24 kB load memory ▶ RS485 interface
Technical data power supply				
Power supply (rated value)	DC 24 V	DC 24 V	DC 24 V	DC 24 V
Power supply (permitted range)	DC 20.4...28.8 V	DC 20.4...28.8 V	DC 20.4...28.8 V	DC 20.4...28.8 V
Reverse polarity protection	✓	✓	✓	✓
Current consumption (no-load operation)	100 mA	100 mA	100 mA	110 mA
Current consumption (rated value)	1 A	1 A	1 A	1 A
Inrush current	58 A	58 A	58 A	58 A
I ² t	0.38 A ² s	0.38 A ² s	0.38 A ² s	0.38 A ² s
Max. current drain at backplane bus	0.8 A	0.8 A	0.8 A	0.8 A
Power loss	9 W	9 W	9 W	9 W
Reverse polarity protection	✓	✓	✓	✓
Technical data digital inputs				
Number of inputs	16 (20)	16 (20)	16 (20)	16 (20)
Cable length, shielded	1000 m	1000 m	1000 m	1000 m
Cable length, unshielded	600 m	600 m	600 m	600 m
Rated load voltage	DC 24 V	DC 24 V	DC 24 V	DC 24 V
Reverse polarity protection of rated load voltage	✓	✓	✓	✓
Current consumption from load voltage L+ (without load)	-	-	-	-
Rated value	DC 24 V	DC 24 V	DC 24 V	DC 24 V
Input voltage for signal "0"	DC 0...5 V	DC 0...5 V	DC 0...5 V	DC 0...5 V
Input voltage for signal "1"	DC 15...28.8 V	DC 15...28.8 V	DC 15...28.8 V	DC 15...28.8 V
Input current for signal "1"	7 mA	7 mA	7 mA	7 mA
Connection of Two-Wire-BEROs possible	✓	✓	✓	✓
Max. permissible BERO quiescent current	1.5 mA	1.5 mA	1.5 mA	1.5 mA
Input delay of "0" to "1"	3 ms	3 ms	3 ms	3 ms
Input delay of "1" to "0"	3 ms	3 ms	3 ms	3 ms
Input characteristic curve	IEC 61131-2, type 1	IEC 61131-2, type 1	IEC 61131-2, type 1	IEC 61131-2, type 1
Initial data size	3 Byte	3 Byte	3 Byte	3 Byte

CPU | CPU STEP7 programmable, PtP

115-6BL12 115-6BL13 115-6BL14 115-6BL32	115-6BL33 115-6BL34					
--	------------------------	--	--	--	--	--

Order number	115-6BL12	115-6BL13	115-6BL14	115-6BL32
Technical data digital outputs				
Number of outputs	16 (12)	16 (12)	16 (12)	16 (12)
Cable length, shielded	1000 m	1000 m	1000 m	1000 m
Cable length, unshielded	600 m	600 m	600 m	600 m
Rated load voltage	DC 24 V	DC 24 V	DC 24 V	DC 24 V
Reverse polarity protection of rated load voltage	-	-	-	-
Current consumption from load voltage L+ (without load)	50 mA	50 mA	50 mA	50 mA
Total current per group, horizontal configuration, 40°C	4 A	4 A	4 A	4 A
Total current per group, horizontal configuration, 60°C	4 A	4 A	4 A	4 A
Total current per group, vertical configuration	4 A	4 A	4 A	4 A
Output voltage signal "1" at min. current	L+ (-125 mV)	L+ (-125 mV)	L+ (-125 mV)	L+ (-125 mV)
Output voltage signal "1" at max. current	L+ (-0.8 V)	L+ (-0.8 V)	L+ (-0.8 V)	L+ (-0.8 V)
Output current at signal "1", rated value	0.5 A	0.5 A	0.5 A	0.5 A
Output delay of "0" to "1"	max. 100 µs	max. 100 µs	max. 100 µs	max. 100 µs
Output delay of "1" to "0"	max. 350 µs	max. 350 µs	max. 350 µs	max. 350 µs
Minimum load current	-	-	-	-
Lamp load	5 W	5 W	5 W	5 W
Switching frequency with resistive load	max. 1000 Hz	max. 1000 Hz	max. 1000 Hz	max. 1000 Hz
Switching frequency with inductive load	max. 0.5 Hz	max. 0.5 Hz	max. 0.5 Hz	max. 0.5 Hz
Switching frequency on lamp load	max. 10 Hz	max. 10 Hz	max. 10 Hz	max. 10 Hz
Internal limitation of inductive shut-off voltage	L+ (-52 V)	L+ (-52 V)	L+ (-52 V)	L+ (-52 V)
Short-circuit protection of output	yes, electronic	yes, electronic	yes, electronic	yes, electronic
Trigger level	1 A	1 A	1 A	1 A
Output data size	3 Byte	3 Byte	3 Byte	3 Byte
Technical data counters				
Number of counters	4	4	4	4
Counter width	32 Bit	32 Bit	32 Bit	32 Bit
Maximum input frequency	30 kHz	30 kHz	30 kHz	30 kHz
Maximum count frequency	30 kHz	30 kHz	30 kHz	30 kHz
Mode incremental encoder	✓	✓	✓	✓
Mode pulse / direction	✓	✓	✓	✓
Mode pulse	✓	✓	✓	✓
Mode frequency counter	-	-	-	-
Mode period measurement	-	-	-	-
Gate input available	✓	✓	✓	✓
Latch input available	-	-	-	-
Reset input available	-	-	-	-
Counter output available	-	-	-	-

CPUs CPUs STEP7 programmable, PtP					
115-6BL12	115-6BL33				
115-6BL13	115-6BL34				
115-6BL14					
115-6BL32					

Order number	115-6BL12	115-6BL13	115-6BL14	115-6BL32
Status information, alarms, diagnostics				
Status display	yes	yes	yes	yes
Interrupts	yes	yes	yes	yes
Process alarm	yes	yes	yes	yes
Diagnostic interrupt	yes	yes	yes	yes
Diagnostic functions	no	no	no	no
Diagnostics information read-out	possible	possible	possible	possible
Supply voltage display	green LED	green LED	green LED	green LED
Group error display	red SF LED	red SF LED	red SF LED	red SF LED
Channel error display	none	none	none	none
Isolation				
Between channels of groups to	8	8	8	8
Between channels and backplane bus	✓	✓	✓	✓
Insulation tested with	DC 500 V	DC 500 V	DC 500 V	DC 500 V
PWM data				
PWM channels	2	2	2	2
PWM time basis	-	-	-	-
Period length	-	-	-	-
Minimum pulse width	-	-	-	-
PtP communication	-	-	-	-
Load and working memory				
Load memory, integrated	24 KB	32 KB	40 KB	24 KB
Load memory, maximum	24 KB	32 KB	40 KB	24 KB
Work memory, integrated	16 KB	24 KB	32 KB	16 KB
Work memory, maximal	16 KB	24 KB	32 KB	16 KB
Memory divided in 50% program / 50% data	-	-	-	-
Memory card slot	MMC-Card with max. 512 MB	MMC-Card with max. 512 MB	MMC-Card with max. 512 MB	MMC-Card with max. 512 MB
Hardware configuration				
Racks, max.	1	1	1	1
Modules per rack, max.	4	4	4	4
Number of integrated DP master	-	-	-	-
Number of DP master via CP	4	4	4	4
Operable function modules	4	4	4	4
Operable communication modules PtP	4	4	4	4
Operable communication modules LAN	-	-	-	-
Command processing times				
Bit instructions, min.	0.25 µs	0.25 µs	0.25 µs	0.25 µs
Word instruction, min.	1.2 µs	1.2 µs	1.2 µs	1.2 µs
Double integer arithmetic, min.	2.6 µs	2.6 µs	2.6 µs	2.6 µs
Floating-point arithmetic, min.	50 µs	50 µs	50 µs	50 µs

SLIO
100V
200V
300S
500S
HMI
Teleservice
StarterKits
Safety
Solutions
Software
Accessories
Appendix

CPU CPU STEP7 programmable, PtP						
115-6BL12	115-6BL33					
115-6BL13	115-6BL34					
115-6BL14						
115-6BL32						

Order number	115-6BL12	115-6BL13	115-6BL14	115-6BL32
Timers/Counters and their retentive characteristics				
Number of S7 counters	256	256	256	256
S7 counter remanence	adjustable 0 up to 64	adjustable 0 up to 64	adjustable 0 up to 64	adjustable 0 up to 64
S7 counter remanence adjustable	C0 .. C7	C0 .. C7	C0 .. C7	C0 .. C7
Number of S7 times	256	256	256	256
S7 times remanence	adjustable 0 up to 128	adjustable 0 up to 128	adjustable 0 up to 128	adjustable 0 up to 128
S7 times remanence adjustable	not retentive	not retentive	not retentive	not retentive
Data range and retentive characteristic				
Number of flags	8192 Bit	8192 Bit	8192 Bit	8192 Bit
Bit memories retentive characteristic adjustable	adjustable 0 up to 256	adjustable 0 up to 256	adjustable 0 up to 256	adjustable 0 up to 256
Bit memories retentive characteristic preset	MB0 .. MB15	MB0 .. MB15	MB0 .. MB15	MB0 .. MB15
Number of data blocks	2047	2047	2047	2047
Max. data blocks size	16 KB	16 KB	16 KB	16 KB
Number range DBs	1 ... 2047	1 ... 2047	1 ... 2047	1 ... 2047
Max. local data size per execution level	1024 Byte	1024 Byte	1024 Byte	1024 Byte
Max. local data size per block	1024 Byte	1024 Byte	1024 Byte	1024 Byte
Blocks				
Number of OBs	14	14	14	14
Maximum OB size	16 KB	16 KB	16 KB	16 KB
Total number DBs, FBs, FCs	-	-	-	-
Number of FBs	1024	1024	1024	1024
Maximum FB size	16 KB	16 KB	16 KB	16 KB
Number range FBs	0 ... 1023	0 ... 1023	0 ... 1023	0 ... 1023
Number of FCs	1024	1024	1024	1024
Maximum FC size	16 KB	16 KB	16 KB	16 KB
Number range FC2	0 ... 1023	0 ... 1023	0 ... 1023	0 ... 1023
Maximum nesting depth per priority class	8	8	8	8
Maximum nesting depth additional within an error OB	1	1	1	1
Time				
Real-time clock buffered	✓	✓	✓	✓
Clock buffered period (min.)	30 d	30 d	30 d	30 d
Type of buffering	-	-	-	-
Load time for 50% buffering period	20 h	20 h	20 h	20 h
Load time for 100% buffering period	48 h	48 h	48 h	48 h
Accuracy (max. deviation per day)	10 s	10 s	10 s	10 s
Number of operating hours counter	8	8	8	8
Clock synchronization	-	-	-	-
Synchronization via MPI	-	-	-	-
Synchronization via Ethernet (NTP)	-	-	-	-
Address areas (I/O)				
Input I/O address area	1024 Byte	1024 Byte	1024 Byte	1024 Byte
Output I/O address area	1024 Byte	1024 Byte	1024 Byte	1024 Byte
Process image adjustable	-	-	-	-

CPUs CPUs STEP7 programmable, PtP					
115-6BL12	115-6BL33				
115-6BL13	115-6BL34				
115-6BL14					
115-6BL32					

Order number	115-6BL12	115-6BL13	115-6BL14	115-6BL32
Input process image preset	128 Byte	128 Byte	128 Byte	128 Byte
Output process image preset	128 Byte	128 Byte	128 Byte	128 Byte
Input process image maximal	128 Byte	128 Byte	128 Byte	128 Byte
Output process image maximal	128 Byte	128 Byte	128 Byte	128 Byte
Digital inputs	8192	8192	8192	8192
Digital outputs	8192	8192	8192	8192
Digital inputs central	148	148	148	148
Digital outputs central	144	144	144	144
Integrated digital inputs	16 (20)	16 (20)	16 (20)	16 (20)
Integrated digital outputs	16 (12)	16 (12)	16 (12)	16 (12)
Analog inputs	512	512	512	512
Analog outputs	512	512	512	512
Analog inputs, central	32	32	32	32
Analog outputs, central	16	16	16	16
Integrated analog inputs	-	-	-	-
Integrated analog outputs	-	-	-	-
Communication functions				
PG/OP channel	✓	✓	✓	✓
Global data communication	✓	✓	✓	✓
Number of GD circuits, max.	4	4	4	4
Size of GD packets, max.	22 Byte	22 Byte	22 Byte	22 Byte
S7 basic communication	✓	✓	✓	✓
S7 basic communication, user data per job	76 Byte	76 Byte	76 Byte	76 Byte
S7 communication	✓	✓	✓	✓
S7 communication as server	✓	✓	✓	✓
S7 communication as client	-	-	-	-
S7 communication, user data per job	160 Byte	160 Byte	160 Byte	160 Byte
Number of connections, max.	16	16	16	16
Functionality Sub-D interfaces				
Type	MP2I	MP2I	MP2I	MP2I
Type of interface	RS485	RS485	RS485	RS485
Connector	Sub-D, 9-pin, female	Sub-D, 9-pin, female	Sub-D, 9-pin, female	Sub-D, 9-pin, female
Electrically isolated	-	-	-	-
MPI	✓	✓	✓	✓
MP2I (MPI/RS232)	✓	✓	✓	✓
DP master	-	-	-	-
DP slave	-	-	-	-
Point-to-point interface	-	-	-	-
Functionality COM interfaces				
Type	COM	COM	COM	COM
Type of interface	RS232	RS232	RS232	RS485
Connector	Sub-D, 9-pin, male	Sub-D, 9-pin, male	Sub-D, 9-pin, male	Sub-D, 9-pin, female
Electrically isolated	-	-	-	✓
MPI	-	-	-	-

CPU CPU STEP7 programmable, PtP					
115-6BL12	115-6BL33				
115-6BL13	115-6BL34				
115-6BL14					
115-6BL32					

Order number	115-6BL12	115-6BL13	115-6BL14	115-6BL32
MP ² (MPI/RS232)	-	-	-	-
DP master	-	-	-	-
DP slave	-	-	-	-
Point-to-point interface	✓	✓	✓	✓
Functionality MPI				
Number of connections, max.	16	16	16	16
PG/OP channel	✓	✓	✓	✓
Routing	-	-	-	-
Global data communication	✓	✓	✓	✓
S7 basic communication	✓	✓	✓	✓
S7 communication	✓	✓	✓	✓
S7 communication as server	✓	✓	✓	✓
S7 communication as client	-	-	-	-
Transmission speed, min.	19.2 kbit/s	19.2 kbit/s	19.2 kbit/s	19.2 kbit/s
Transmission speed, max.	187.5 kbit/s	187.5 kbit/s	187.5 kbit/s	187.5 kbit/s
Point-to-point communication				
PtP communication	✓	✓	✓	✓
Interface isolated	-	-	-	✓
RS232 interface	✓	✓	✓	-
RS422 interface	-	-	-	-
RS485 interface	-	-	-	✓
Connector	Sub-D, 9-pin, male	Sub-D, 9-pin, male	Sub-D, 9-pin, male	Sub-D, 9-pin, female
Transmission speed, min.	150 bit/s	150 bit/s	150 bit/s	150 bit/s
Transmission speed, max.	115.2 kbit/s	115.2 kbit/s	115.2 kbit/s	115.2 kbit/s
Cable length, max.	15 m	15 m	15 m	500 m
Point-to-point protocol				
ASCII protocol	✓	✓	✓	✓
STX/ETX protocol	✓	✓	✓	✓
3964(R) protocol	✓	✓	✓	✓
RK512 protocol	-	-	-	-
USS master protocol	✓	✓	✓	✓
Modbus master protocol	✓	✓	✓	✓
Modbus slave protocol	✓	✓	✓	✓
Special protocols	-	-	-	-
Housing				
Material	PPE / PA 6.6	PPE / PA 6.6	PPE / PA 6.6	PPE / PA 6.6
Mounting	Profile rail 35 mm	Profile rail 35 mm	Profile rail 35 mm	Profile rail 35 mm
Mechanical data				
Dimensions (WxHxD)	152.4 mm x 76 mm x 48 mm	152.4 mm x 76 mm x 48 mm	152.4 mm x 76 mm x 48 mm	152.4 mm x 76 mm x 48 mm
Weight	302 g	302 g	302 g	302 g
Environmental conditions				
Operating temperature	0 °C to 60 °C	0 °C to 60 °C	0 °C to 60 °C	0 °C to 60 °C
Storage temperature	-25 °C to 70 °C	-25 °C to 70 °C	-25 °C to 70 °C	-25 °C to 70 °C
Certifications				
UL508 certification	yes	yes	yes	yes

SLIO
100V
200V
300S
500S
HMI
Teleservice
StarterKits
Safety
Solutions
Software
Accessories
Appendix

Connections, Interfaces

CPUs CPUs STEP7 programmable, PtP					
115-6BL12	115-6BL33				
115-6BL13	115-6BL34				
115-6BL14					
115-6BL32					

115-6BL12

MP1

- ① reserved
- ② M24V
- ③ RxD/TxD-P
- ④ RTS
- ⑤ M5V
- ⑥ P5V
- ⑦ P24V
- ⑧ RxD/TxD-N
- ⑨ n.c.

X1

- ① L+
- ② M
- ③ PE

COM RS232

- ① CD-
- ② RxD
- ③ TxD
- ④ DTR-
- ⑤ GND
- ⑥ DSR-
- ⑦ RTS-
- ⑧ CTS-
- ⑨ RI-

X3

1 2 3 4 5 6 7 8 9 10

DC 24V

1M

X4

1 2 3 4 5 6 7 8 9 10

DC 24V

2M

X5

1 2 3 4 5 6 7 8 9 10

DC 24V

3M

X6

1 2 3 4 5 6 7 8 9 10

DC 24V

4M

115-6BL13

MP1

- ① reserved
- ② M24V
- ③ RxD/TxD-P
- ④ RTS
- ⑤ M5V
- ⑥ P5V
- ⑦ P24V
- ⑧ RxD/TxD-N
- ⑨ n.c.

X1

- ① L+
- ② M
- ③ PE

COM RS232

- ① CD-
- ② RxD
- ③ TxD
- ④ DTR-
- ⑤ GND
- ⑥ DSR-
- ⑦ RTS-
- ⑧ CTS-
- ⑨ RI-

X3

1 2 3 4 5 6 7 8 9 10

DC 24V

1M

X4

1 2 3 4 5 6 7 8 9 10

DC 24V

2M

X5

1 2 3 4 5 6 7 8 9 10

DC 24V

3M

X6

1 2 3 4 5 6 7 8 9 10

DC 24V

4M

115-6BL14

MP1

- ① reserved
- ② M24V
- ③ RxD/TxD-P
- ④ RTS
- ⑤ M5V
- ⑥ P5V
- ⑦ P24V
- ⑧ RxD/TxD-N
- ⑨ n.c.

X1

- ① L+
- ② M
- ③ PE

COM RS232

- ① CD-
- ② RxD
- ③ TxD
- ④ DTR-
- ⑤ GND
- ⑥ DSR-
- ⑦ RTS-
- ⑧ CTS-
- ⑨ RI-

X3

1 2 3 4 5 6 7 8 9 10

DC 24V

1M

X4

1 2 3 4 5 6 7 8 9 10

DC 24V

2M

X5

1 2 3 4 5 6 7 8 9 10

DC 24V

3M

X6

1 2 3 4 5 6 7 8 9 10

DC 24V

4M

115-6BL32

MP1

- ① reserved
- ② M24V
- ③ RxD/TxD-P
- ④ RTS
- ⑤ M5V
- ⑥ P5V
- ⑦ P24V
- ⑧ RxD/TxD-N
- ⑨ n.c.

X1

- ① L+
- ② M
- ③ PE

RS485

- ① n.c.
- ② n.c.
- ③ RxD/TxD-P
- ④ RTS
- ⑤ M5V
- ⑥ P5V
- ⑦ n.c.
- ⑧ RxD/TxD-N
- ⑨ n.c.

X3

1 2 3 4 5 6 7 8 9 10

DC 24V

1M

X4

1 2 3 4 5 6 7 8 9 10

DC 24V

2M

X5

1 2 3 4 5 6 7 8 9 10

DC 24V

3M

X6

1 2 3 4 5 6 7 8 9 10



DC 24V

4M

CPU STEP7 programmable, PtP

CPU | CPU STEP7 programmable, PtP

115-6BL12 115-6BL13 115-6BL14 115-6BL32	115-6BL33 115-6BL34				
--	------------------------	--	--	--	--

Order number	115-6BL33	115-6BL34		
Figure				
Type	CPU 115SER	CPU 115SER		
General information				
Note	-	-		
Features	<ul style="list-style-type: none"> ▶ 16 (20) inputs ▶ 16 (12) outputs ▶ from which are 2 PWM 50 kHz outputs ▶ 24 kB work memory, 32 kB load memory ▶ RS485 interface 	<ul style="list-style-type: none"> ▶ 16 (20) inputs ▶ 16 (12) outputs ▶ from which are 2 PWM 50 kHz outputs ▶ 32 kB work memory, 40 kB load memory ▶ RS485 interface 		
Technical data power supply				
Power supply (rated value)	DC 24 V	DC 24 V		
Power supply (permitted range)	DC 20.4...28.8 V	DC 20.4...28.8 V		
Reverse polarity protection	✓	✓		
Current consumption (no-load operation)	110 mA	110 mA		
Current consumption (rated value)	1 A	1 A		
Inrush current	58 A	58 A		
I ² t	0.38 A ² s	0.38 A ² s		
Max. current drain at backplane bus	0.8 A	0.8 A		
Power loss	9 W	9 W		
Reverse polarity protection	✓	✓		
Technical data digital inputs				
Number of inputs	16 (20)	16 (20)		
Cable length, shielded	1000 m	1000 m		
Cable length, unshielded	600 m	600 m		
Rated load voltage	DC 24 V	DC 24 V		
Reverse polarity protection of rated load voltage	✓	✓		
Current consumption from load voltage L+ (without load)	-	-		
Rated value	DC 24 V	DC 24 V		
Input voltage for signal "0"	DC 0...5 V	DC 0...5 V		
Input voltage for signal "1"	DC 15...28.8 V	DC 15...28.8 V		
Input current for signal "1"	7 mA	7 mA		
Connection of Two-Wire-BEROs possible	✓	✓		
Max. permissible BERO quiescent current	1.5 mA	1.5 mA		
Input delay of "0" to "1"	3 ms	3 ms		
Input delay of "1" to "0"	3 ms	3 ms		
Input characteristic curve	IEC 61131-2, type 1	IEC 61131-2, type 1		
Initial data size	3 Byte	3 Byte		

CPU CPUs STEP7 programmable, PtP					
115-6BL12	115-6BL33				
115-6BL13	115-6BL34				
115-6BL14					
115-6BL32					

Order number	115-6BL33	115-6BL34		
Technical data digital outputs				
Number of outputs	16 (12)	16 (12)		
Cable length, shielded	1000 m	1000 m		
Cable length, unshielded	600 m	600 m		
Rated load voltage	DC 24 V	DC 24 V		
Reverse polarity protection of rated load voltage	-	-		
Current consumption from load voltage L+ (without load)	50 mA	50 mA		
Total current per group, horizontal configuration, 40°C	4 A	4 A		
Total current per group, horizontal configuration, 60°C	4 A	4 A		
Total current per group, vertical configuration	4 A	4 A		
Output voltage signal "1" at min. current	L+ (-125 mV)	L+ (-125 mV)		
Output voltage signal "1" at max. current	L+ (-0.8 V)	L+ (-0.8 V)		
Output current at signal "1", rated value	0.5 A	0.5 A		
Output delay of "0" to "1"	max. 100 µs	max. 100 µs		
Output delay of "1" to "0"	max. 350 µs	max. 350 µs		
Minimum load current	-	-		
Lamp load	5 W	5 W		
Switching frequency with resistive load	max. 1000 Hz	max. 1000 Hz		
Switching frequency with inductive load	max. 0.5 Hz	max. 0.5 Hz		
Switching frequency on lamp load	max. 10 Hz	max. 10 Hz		
Internal limitation of inductive shut-off voltage	L+ (-52 V)	L+ (-52 V)		
Short-circuit protection of output	yes, electronic	yes, electronic		
Trigger level	1 A	1 A		
Output data size	3 Byte	3 Byte		
Technical data counters				
Number of counters	4	4		
Counter width	32 Bit	32 Bit		
Maximum input frequency	30 kHz	30 kHz		
Maximum count frequency	30 kHz	30 kHz		
Mode incremental encoder	✓	✓		
Mode pulse / direction	✓	✓		
Mode pulse	✓	✓		
Mode frequency counter	-	-		
Mode period measurement	-	-		
Gate input available	✓	✓		
Latch input available	-	-		
Reset input available	-	-		
Counter output available	-	-		
Status information, alarms, diagnostics				
Status display	yes	yes		
Interrupts	yes	yes		

CPUs CPUs STEP7 programmable, PtP					
115-6BL12	115-6BL33				
115-6BL13	115-6BL34				
115-6BL14					
115-6BL32					

Order number	115-6BL33	115-6BL34		
Process alarm	yes	yes		
Diagnostic interrupt	yes	yes		
Diagnostic functions	no	no		
Diagnostics information read-out	possible	possible		
Supply voltage display	green LED	green LED		
Group error display	red SF LED	red SF LED		
Channel error display	none	none		
Isolation				
Between channels of groups to	8	8		
Between channels and backplane bus	✓	✓		
Insulation tested with	DC 500 V	DC 500 V		
PWM data				
PWM channels	2	2		
PWM time basis	-	-		
Period length	-	-		
Minimum pulse width	-	-		
PtP communication	-	-		
Load and working memory				
Load memory, integrated	32 KB	40 KB		
Load memory, maximum	32 KB	40 KB		
Work memory, integrated	24 KB	32 KB		
Work memory, maximal	24 KB	32 KB		
Memory divided in 50% program / 50% data	-	-		
Memory card slot	MMC-Card with max. 512 MB	MMC-Card with max. 512 MB		
Hardware configuration				
Racks, max.	1	1		
Modules per rack, max.	4	4		
Number of integrated DP master	-	-		
Number of DP master via CP	4	4		
Operable function modules	4	4		
Operable communication modules PtP	4	4		
Operable communication modules LAN	-	-		
Command processing times				
Bit instructions, min.	0.25 µs	0.25 µs		
Word instruction, min.	1.2 µs	1.2 µs		
Double integer arithmetic, min.	2.6 µs	2.6 µs		
Floating-point arithmetic, min.	50 µs	50 µs		
Timers/Counters and their retentive characteristics				
Number of S7 counters	256	256		
S7 counter remanence	adjustable 0 up to 64	adjustable 0 up to 64		
S7 counter remanence adjustable	C0 .. C7	C0 .. C7		
Number of S7 times	256	256		
S7 times remanence	adjustable 0 up to 128	adjustable 0 up to 128		
S7 times remanence adjustable	not retentive	not retentive		

CPUs CPUs STEP7 programmable, PtP					
115-6BL12	115-6BL33				
115-6BL13	115-6BL34				
115-6BL14					
115-6BL32					

Order number	115-6BL33	115-6BL34		
Data range and retentive characteristic				
Number of flags	8192 Bit	8192 Bit		
Bit memories retentive characteristic adjustable	adjustable 0 up to 256	adjustable 0 up to 256		
Bit memories retentive characteristic preset	MB0 .. MB15	MB0 .. MB15		
Number of data blocks	2047	2047		
Max. data blocks size	16 KB	16 KB		
Number range DBs	1 ... 2047	1 ... 2047		
Max. local data size per execution level	1024 Byte	1024 Byte		
Max. local data size per block	1024 Byte	1024 Byte		
Blocks				
Number of OBs	14	14		
Maximum OB size	16 KB	16 KB		
Total number DBs, FBs, FCs	-	-		
Number of FBs	1024	1024		
Maximum FB size	16 KB	16 KB		
Number range FBs	0 ... 1023	0 ... 1023		
Number of FCs	1024	1024		
Maximum FC size	16 KB	16 KB		
Number range FC2	0 ... 1023	0 ... 1023		
Maximum nesting depth per priority class	8	8		
Maximum nesting depth additional within an error OB	1	1		
Time				
Real-time clock buffered	✓	✓		
Clock buffered period (min.)	30 d	30 d		
Type of buffering	-	-		
Load time for 50% buffering period	20 h	20 h		
Load time for 100% buffering period	48 h	48 h		
Accuracy (max. deviation per day)	10 s	10 s		
Number of operating hours counter	8	8		
Clock synchronization	-	-		
Synchronization via MPI	-	-		
Synchronization via Ethernet (NTP)	-	-		
Address areas (I/O)				
Input I/O address area	1024 Byte	1024 Byte		
Output I/O address area	1024 Byte	1024 Byte		
Process image adjustable	-	-		
Input process image preset	128 Byte	128 Byte		
Output process image preset	128 Byte	128 Byte		
Input process image maximal	128 Byte	128 Byte		
Output process image maximal	128 Byte	128 Byte		
Digital inputs	8192	8192		
Digital outputs	8192	8192		
Digital inputs central	148	148		

CPU CPU STEP7 programmable, PtP						
115-6BL12	115-6BL33					
115-6BL13	115-6BL34					
115-6BL14						
115-6BL32						

Order number	115-6BL33	115-6BL34		
Digital outputs central	144	144		
Integrated digital inputs	16 (20)	16 (20)		
Integrated digital outputs	16 (12)	16 (12)		
Analog inputs	512	512		
Analog outputs	512	512		
Analog inputs, central	32	32		
Analog outputs, central	16	16		
Integrated analog inputs	-	-		
Integrated analog outputs	-	-		
Communication functions				
PG/OP channel	✓	✓		
Global data communication	✓	✓		
Number of GD circuits, max.	4	4		
Size of GD packets, max.	22 Byte	22 Byte		
S7 basic communication	✓	✓		
S7 basic communication, user data per job	76 Byte	76 Byte		
S7 communication	✓	✓		
S7 communication as server	✓	✓		
S7 communication as client	-	-		
S7 communication, user data per job	160 Byte	160 Byte		
Number of connections, max.	16	16		
Functionality Sub-D interfaces				
Type	MP2I	MP2I		
Type of interface	RS485	RS485		
Connector	Sub-D, 9-pin, female	Sub-D, 9-pin, female		
Electrically isolated	-	-		
MPI	✓	✓		
MP2I (MPI/RS232)	✓	✓		
DP master	-	-		
DP slave	-	-		
Point-to-point interface	-	-		
Functionality COM interfaces				
Type	COM	COM		
Type of interface	RS485	RS485		
Connector	Sub-D, 9-pin, female	Sub-D, 9-pin, female		
Electrically isolated	✓	✓		
MPI	-	-		
MP2I (MPI/RS232)	-	-		
DP master	-	-		
DP slave	-	-		
Point-to-point interface	✓	✓		
Functionality MPI				
Number of connections, max.	16	16		
PG/OP channel	✓	✓		
Routing	-	-		

CPU CPU STEP7 programmable, PtP					
115-6BL12	115-6BL33				
115-6BL13	115-6BL34				
115-6BL14					
115-6BL32					

Order number	115-6BL33	115-6BL34		
Global data communication	✓	✓		
S7 basic communication	✓	✓		
S7 communication	✓	✓		
S7 communication as server	✓	✓		
S7 communication as client	-	-		
Transmission speed, min.	19.2 kbit/s	19.2 kbit/s		
Transmission speed, max.	187.5 kbit/s	187.5 kbit/s		
Point-to-point communication				
PtP communication	✓	✓		
Interface isolated	✓	✓		
RS232 interface	-	-		
RS422 interface	-	-		
RS485 interface	✓	✓		
Connector	Sub-D, 9-pin, female	Sub-D, 9-pin, female		
Transmission speed, min.	150 bit/s	150 bit/s		
Transmission speed, max.	115.2 kbit/s	115.2 kbit/s		
Cable length, max.	500 m	500 m		
Point-to-point protocol				
ASCII protocol	✓	✓		
STX/ETX protocol	✓	✓		
3964(R) protocol	✓	✓		
RK512 protocol	-	-		
USS master protocol	✓	✓		
Modbus master protocol	✓	✓		
Modbus slave protocol	✓	✓		
Special protocols	-	-		
Housing				
Material	PPE / PA 6.6	PPE / PA 6.6		
Mounting	Profile rail 35 mm	Profile rail 35 mm		
Mechanical data				
Dimensions (WxHxD)	152.4 mm x 76 mm x 48 mm	152.4 mm x 76 mm x 48 mm		
Weight	302 g	302 g		
Environmental conditions				
Operating temperature	0 °C to 60 °C	0 °C to 60 °C		
Storage temperature	-25 °C to 70 °C	-25 °C to 70 °C		
Certifications				
UL508 certification	yes	yes		

Connections, Interfaces

CPUs CPUs STEP7 programmable, PtP					
115-6BL12	115-6BL33				
115-6BL13	115-6BL34				
115-6BL14					
115-6BL32					

115-6BL33



MP1

- ① reserved
- ② M24V
- ③ RxD/TxD-P
- ④ RTS
- ⑤ M5V
- ⑥ PSV
- ⑦ P24V
- ⑧ RxD/TxD-N
- ⑨ n.c.

X1

- ① L+
- ② M
- ③ PE

RS485

- ① n.c.
- ② n.c.
- ③ RxD/TxD-P
- ④ RTS
- ⑤ M5V
- ⑥ PSV
- ⑦ n.c.
- ⑧ RxD/TxD-N
- ⑨ n.c.

X3

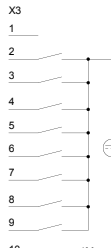

X4

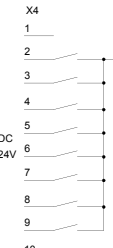

X5

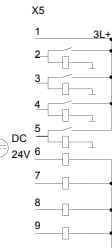

X6

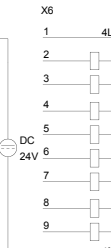

115-6BL34



MP1

- ① reserved
- ② M24V
- ③ RxD/TxD-P
- ④ RTS
- ⑤ M5V
- ⑥ PSV
- ⑦ P24V
- ⑧ RxD/TxD-N
- ⑨ n.c.

X1

- ① L+
- ② M
- ③ PE

RS485

- ① n.c.
- ② n.c.
- ③ RxD/TxD-P
- ④ RTS
- ⑤ M5V
- ⑥ PSV
- ⑦ n.c.
- ⑧ RxD/TxD-N
- ⑨ n.c.

X3

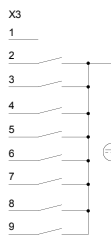

X4

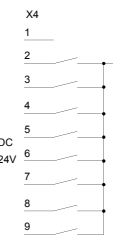

X5

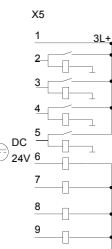

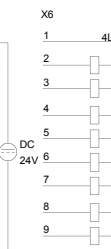

X6



CPUs STEP7 programmable, DP slave

CPUs CPUs STEP7 programmable, DP slave					
115-6BL22					
115-6BL23					
115-6BL24					

Order number	115-6BL22	115-6BL23	115-6BL24	
Figure				
Type	CPU 115DP	CPU 115DP	CPU 115DP	
General information				
Note	-	-	-	
Features	<ul style="list-style-type: none"> ▶ 16 (20) inputs ▶ 16 (12) outputs ▶ 16 kB work memory, 24 kB load memory ▶ PROFIBUS-DP slave interface 	<ul style="list-style-type: none"> ▶ 16 (20) inputs ▶ 16 (12) outputs ▶ from which are 2 PWM 50 kHz outputs ▶ 24 kB work memory, 32 kB load memory ▶ PROFIBUS-DP slave interface 	<ul style="list-style-type: none"> ▶ 16 (20) inputs ▶ 16 (12) outputs ▶ 32 kB work memory, 40 kB load memory ▶ PROFIBUS-DP slave interface 	
Technical data power supply				
Power supply (rated value)	DC 24 V	DC 24 V	DC 24 V	
Power supply (permitted range)	DC 20.4...28.8 V	DC 20.4...28.8 V	DC 20.4...28.8 V	
Reverse polarity protection	✓	✓	✓	
Current consumption (no-load operation)	160 mA	160 mA	160 mA	
Current consumption (rated value)	1 A	1 A	1 A	
Inrush current	58 A	58 A	58 A	
I^2t	0.38 A ² s	0.38 A ² s	0.38 A ² s	
Max. current drain at backplane bus	0.8 A	0.8 A	0.8 A	
Power loss	9 W	9 W	9 W	
Reverse polarity protection	✓	✓	✓	
Technical data digital inputs				
Number of inputs	16 (20)	16 (20)	16 (20)	
Cable length, shielded	1000 m	1000 m	1000 m	
Cable length, unshielded	600 m	600 m	600 m	
Rated load voltage	DC 24 V	DC 24 V	DC 24 V	
Reverse polarity protection of rated load voltage	✓	✓	✓	
Current consumption from load voltage L+ (without load)	-	-	-	
Rated value	DC 24 V	DC 24 V	DC 24 V	
Input voltage for signal "0"	DC 0...5 V	DC 0...5 V	DC 0...5 V	
Input voltage for signal "1"	DC 15...28.8 V	DC 15...28.8 V	DC 15...28.8 V	
Input current for signal "1"	7 mA	7 mA	7 mA	
Connection of Two-Wire-BEROs possible	✓	✓	✓	
Max. permissible BERO quiescent current	1.5 mA	1.5 mA	1.5 mA	
Input delay of "0" to "1"	3 ms	3 ms	3 ms	
Input delay of "1" to "0"	3 ms	3 ms	3 ms	
Input characteristic curve	IEC 61131-2, type 1	IEC 61131-2, type 1	IEC 61131-2, type 1	
Initial data size	3 Byte	3 Byte	3 Byte	

SLIO
100V
200V
300S
500S
HMI
Teleservice
StarterKits
Safety
Solutions
Software
Accessories
Appendix

CPU STEP7 programmable, DP slave

115-6BL22
115-6BL23
115-6BL24

Order number	115-6BL22	115-6BL23	115-6BL24	
Technical data digital outputs				
Number of outputs	16 (12)	16 (12)	16 (12)	
Cable length, shielded	1000 m	1000 m	1000 m	
Cable length, unshielded	600 m	600 m	600 m	
Rated load voltage	DC 24 V	DC 24 V	DC 24 V	
Reverse polarity protection of rated load voltage	-	-	-	
Current consumption from load voltage L+ (without load)	50 mA	50 mA	50 mA	
Total current per group, horizontal configuration, 40°C	4 A	4 A	4 A	
Total current per group, horizontal configuration, 60°C	4 A	4 A	4 A	
Total current per group, vertical configuration	4 A	4 A	4 A	
Output voltage signal "1" at min. current	L+ (-125 mV)	L+ (-125 mV)	L+ (-125 mV)	
Output voltage signal "1" at max. current	L+ (-0.8 V)	L+ (-0.8 V)	L+ (-0.8 V)	
Output current at signal "1", rated value	0.5 A	0.5 A	0.5 A	
Output delay of "0" to "1"	max. 100 µs	max. 100 µs	max. 100 µs	
Output delay of "1" to "0"	max. 350 µs	max. 350 µs	max. 350 µs	
Minimum load current	-	-	-	
Lamp load	5 W	5 W	5 W	
Switching frequency with resistive load	max. 1000 Hz	max. 1000 Hz	max. 1000 Hz	
Switching frequency with inductive load	max. 0.5 Hz	max. 0.5 Hz	max. 0.5 Hz	
Switching frequency on lamp load	max. 10 Hz	max. 10 Hz	max. 10 Hz	
Internal limitation of inductive shut-off voltage	L+ (-52 V)	L+ (-52 V)	L+ (-52 V)	
Short-circuit protection of output	yes, electronic	yes, electronic	yes, electronic	
Trigger level	1 A	1 A	1 A	
Output data size	3 Byte	3 Byte	3 Byte	
Technical data counters				
Number of counters	4	4	4	
Counter width	32 Bit	32 Bit	32 Bit	
Maximum input frequency	30 kHz	30 kHz	30 kHz	
Maximum count frequency	30 kHz	30 kHz	30 kHz	
Mode incremental encoder	✓	✓	✓	
Mode pulse / direction	✓	✓	✓	
Mode pulse	✓	✓	✓	
Mode frequency counter	-	-	-	
Mode period measurement	-	-	-	
Gate input available	✓	✓	✓	
Latch input available	-	-	-	
Reset input available	-	-	-	
Counter output available	-	-	-	

CPUs CPUs STEP7 programmable, DP slave					
115-6BL22					
115-6BL23					
115-6BL24					

Order number	115-6BL22	115-6BL23	115-6BL24	
Status information, alarms, diagnostics				
Status display	yes	yes	yes	
Interrupts	yes	yes	yes	
Process alarm	yes	yes	yes	
Diagnostic interrupt	yes	yes	yes	
Diagnostic functions	no	no	no	
Diagnostics information read-out	possible	possible	possible	
Supply voltage display	green LED	green LED	green LED	
Group error display	red SF LED	red SF LED	red SF LED	
Channel error display	none	none	none	
Isolation				
Between channels of groups to	8	8	8	
Between channels and backplane bus	✓	✓	✓	
Insulation tested with	DC 500 V	DC 500 V	DC 500 V	
PWM data				
PWM channels	2	2	2	
PWM time basis	-	-	-	
Period length	-	-	-	
Minimum pulse width	-	-	-	
PtP communication	-	-	-	
Load and working memory				
Load memory, integrated	24 KB	32 KB	40 KB	
Load memory, maximum	24 KB	32 KB	40 KB	
Work memory, integrated	16 KB	24 KB	32 KB	
Work memory, maximal	16 KB	24 KB	32 KB	
Memory divided in 50% program / 50% data	-	-	-	
Memory card slot	MMC-Card with max. 512 MB	MMC-Card with max. 512 MB	MMC-Card with max. 512 MB	
Hardware configuration				
Racks, max.	1	1	1	
Modules per rack, max.	4	4	4	
Number of integrated DP master	-	-	-	
Number of DP master via CP	4	4	4	
Operable function modules	4	4	4	
Operable communication modules PtP	4	4	4	
Operable communication modules LAN	-	-	-	
Command processing times				
Bit instructions, min.	0.25 µs	0.25 µs	0.25 µs	
Word instruction, min.	1.2 µs	1.2 µs	1.2 µs	
Double integer arithmetic, min.	2.6 µs	2.6 µs	2.6 µs	
Floating-point arithmetic, min.	50 µs	50 µs	50 µs	
Timers/Counters and their retentive characteristics				
Number of S7 counters	256	256	256	
S7 counter remanence	adjustable 0 up to 64	adjustable 0 up to 64	adjustable 0 up to 64	
S7 counter remanence adjustable	C0 .. C7	C0 .. C7	C0 .. C7	

SLIO
100V
200V
300S
500S
HMI
Teleservice
StarterKits
Safety
Solutions
Software
Accessories
Appendix

CPUs CPUs STEP7 programmable, DP slave						
115-6BL22						
115-6BL23						
115-6BL24						

Order number	115-6BL22	115-6BL23	115-6BL24	
Number of S7 times	256	256	256	
S7 times remanence	adjustable 0 up to 128	adjustable 0 up to 128	adjustable 0 up to 128	
S7 times remanence adjustable	not retentive	not retentive	not retentive	
Data range and retentive characteristic				
Number of flags	8192 Bit	8192 Bit	8192 Bit	
Bit memories retentive characteristic adjustable	adjustable 0 up to 256	adjustable 0 up to 256	adjustable 0 up to 256	
Bit memories retentive characteristic preset	MB0 .. MB15	MB0 .. MB15	MB0 .. MB15	
Number of data blocks	2047	2047	2047	
Max. data blocks size	16 KB	16 KB	16 KB	
Number range DBs	1 ... 2047	1 ... 2047	1 ... 2047	
Max. local data size per execution level	1024 Byte	1024 Byte	1024 Byte	
Max. local data size per block	1024 Byte	1024 Byte	1024 Byte	
Blocks				
Number of OBs	14	14	14	
Maximum OB size	16 KB	16 KB	16 KB	
Totalnumber DBs, FBs, FCs	-	-	-	
Number of FBs	1024	1024	1024	
Maximum FB size	16 KB	16 KB	16 KB	
Number range FBs	0 ... 1023	0 ... 1023	0 ... 1023	
Number of FCs	1024	1024	1024	
Maximum FC size	16 KB	16 KB	16 KB	
Number range FC2	0 ... 1023	0 ... 1023	0 ... 1023	
Maximum nesting depth per priority class	8	8	8	
Maximum nesting depth additional within an error OB	1	1	1	
Time				
Real-time clock buffered	✓	✓	✓	
Clock buffered period (min.)	30 d	30 d	30 d	
Type of buffering	-	-	-	
Load time for 50% buffering period	20 h	20 h	20 h	
Load time for 100% buffering period	48 h	48 h	48 h	
Accuracy (max. deviation per day)	10 s	10 s	10 s	
Number of operating hours counter	8	8	8	
Clock synchronization	-	-	-	
Synchronization via MPI	-	-	-	
Synchronization via Ethernet (NTP)	-	-	-	
Address areas (I/O)				
Input I/O address area	1024 Byte	1024 Byte	1024 Byte	
Output I/O address area	1024 Byte	1024 Byte	1024 Byte	
Process image adjustable	-	-	-	
Input process image preset	128 Byte	128 Byte	128 Byte	
Output process image preset	128 Byte	128 Byte	128 Byte	
Input process image maximal	128 Byte	128 Byte	128 Byte	
Output process image maximal	128 Byte	128 Byte	128 Byte	

CPUs CPUs STEP7 programmable, DP slave					
115-6BL22					
115-6BL23					
115-6BL24					

Order number	115-6BL22	115-6BL23	115-6BL24	
Digital inputs	8192	8192	8192	
Digital outputs	8192	8192	8192	
Digital inputs central	148	148	148	
Digital outputs central	144	144	144	
Integrated digital inputs	16 (20)	16 (20)	16 (20)	
Integrated digital outputs	16 (12)	16 (12)	16 (12)	
Analog inputs	512	512	512	
Analog outputs	512	512	512	
Analog inputs, central	32	32	32	
Analog outputs, central	16	16	16	
Integrated analog inputs	-	-	-	
Integrated analog outputs	-	-	-	
Communication functions				
PG/OP channel	✓	✓	✓	
Global data communication	✓	✓	✓	
Number of GD circuits, max.	4	4	4	
Size of GD packets, max.	22 Byte	22 Byte	22 Byte	
S7 basic communication	✓	✓	✓	
S7 basic communication, user data per job	76 Byte	76 Byte	76 Byte	
S7 communication	✓	✓	✓	
S7 communication as server	✓	✓	✓	
S7 communication as client	-	-	-	
S7 communication, user data per job	160 Byte	160 Byte	160 Byte	
Number of connections, max.	16	16	16	
Functionality Sub-D interfaces				
Type	MP ² I	MP ² I	MP ² I	
Type of interface	RS485	RS485	RS485	
Connector	Sub-D, 9-pin, female	Sub-D, 9-pin, female	Sub-D, 9-pin, female	
Electrically isolated	-	-	-	
MPI	✓	✓	✓	
MP ² I (MPI/RS232)	✓	✓	✓	
DP master	-	-	-	
DP slave	-	-	-	
Point-to-point interface	-	-	-	
Functionality DP interfaces				
Type	DP	DP	DP	
Type of interface	RS485	RS485	RS485	
Connector	Sub-D, 9-pin, female	Sub-D, 9-pin, female	Sub-D, 9-pin, female	
Electrically isolated	✓	✓	✓	
MPI	-	-	-	
MP ² I (MPI/RS232)	-	-	-	
DP master	-	-	-	
DP slave	yes	yes	yes	
Point-to-point interface	-	-	-	

CPUs CPUs STEP7 programmable, DP slave						
115-6BL22						
115-6BL23						
115-6BL24						

Order number	115-6BL22	115-6BL23	115-6BL24	
Functionality MPI				
Number of connections, max.	16	16	16	
PG/OP channel	✓	✓	✓	
Routing	-	-	-	
Global data communication	✓	✓	✓	
S7 basic communication	✓	✓	✓	
S7 communication	✓	✓	✓	
S7 communication as server	✓	✓	✓	
S7 communication as client	-	-	-	
Transmission speed, min.	19.2 kbit/s	19.2 kbit/s	19.2 kbit/s	
Transmission speed, max.	187.5 kbit/s	187.5 kbit/s	187.5 kbit/s	
Functionality PROFIBUS slave				
PG/OP channel	-	-	-	
Routing	-	-	-	
S7 communication	-	-	-	
S7 communication as server	-	-	-	
S7 communication as client	-	-	-	
Direct data exchange (slave-to-slave communication)	-	-	-	
DPV1	-	-	-	
Transmission speed, min.	9.6 kbit/s	9.6 kbit/s	9.6 kbit/s	
Transmission speed, max.	12 Mbit/s	12 Mbit/s	12 Mbit/s	
Automatic detection of transmission speed	-	-	-	
Transfer memory inputs, max.	64 Byte	64 Byte	64 Byte	
Transfer memory outputs, max.	64 Byte	64 Byte	64 Byte	
Address areas, max.	1	1	1	
User data per address area, max.	64 Byte	64 Byte	64 Byte	
Housing				
Material	PPE / PA 6.6	PPE / PA 6.6	PPE / PA 6.6	
Mounting	Profile rail 35 mm	Profile rail 35 mm	Profile rail 35 mm	
Mechanical data				
Dimensions (WxHxD)	152.4 mm x 76 mm x 48 mm	152.4 mm x 76 mm x 48 mm	152.4 mm x 76 mm x 48 mm	
Weight	330 g	330 g	330 g	
Environmental conditions				
Operating temperature	0 °C to 60 °C	0 °C to 60 °C	0 °C to 60 °C	
Storage temperature	-25 °C to 70 °C	-25 °C to 70 °C	-25 °C to 70 °C	
Certifications				
UL508 certification	yes	yes	yes	

Connections, Interfaces

CPU | CPUs STEP7 programmable, DP slave

115-6BL22
115-6BL23
115-6BL24

115-6BL22

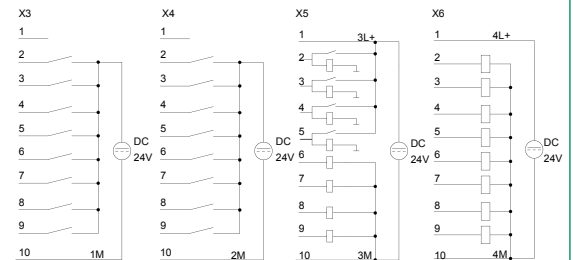
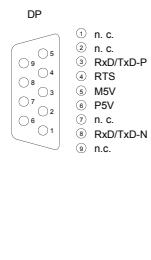
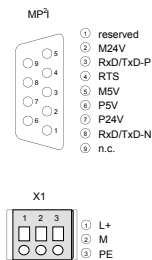

115-6BL23

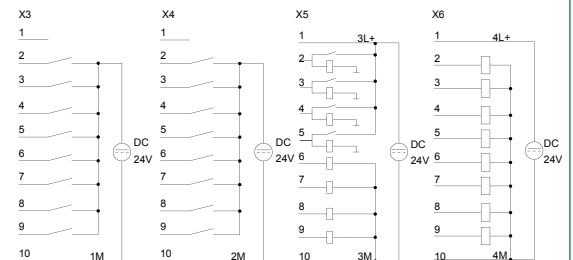
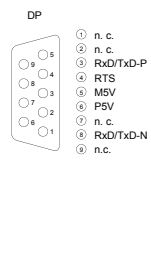
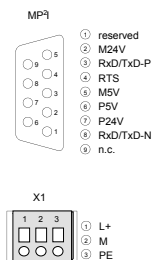

115-6BL24

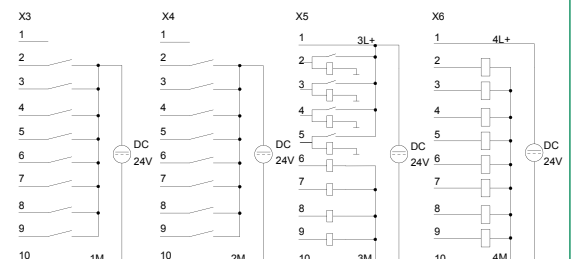
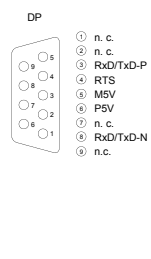
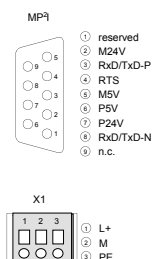

SLIO
100V
200V
300S
500S
HMI
Teleservice
StarterKits
Safety
Solutions
Software
Accessories
Appendix

Clamp modules



Structure and Function

Clamp modules are passive modules for 2- or 3-wire installations, the contacts are electrically connected internally vertically. They offer various connectivity options for signals, mass and plus potentials.

By the use of clamp modules distributors for a power supply can be realized in a simple way and thus offer the possibility for connection of active supplied sensors such as proximity switches. The wiring is carried out using time-saving and secure cage clamp technology

Passive clamp modules have no connection to the backplane bus.

The terminal modules are attached to the mounting surface using a 35 mm profile rail.

Characteristics

- › Maintenance-free cage-clamp technology
- › Maximum terminal current 10 A
- › Assembly with 35 mm profile rail
- › 24 months warranty

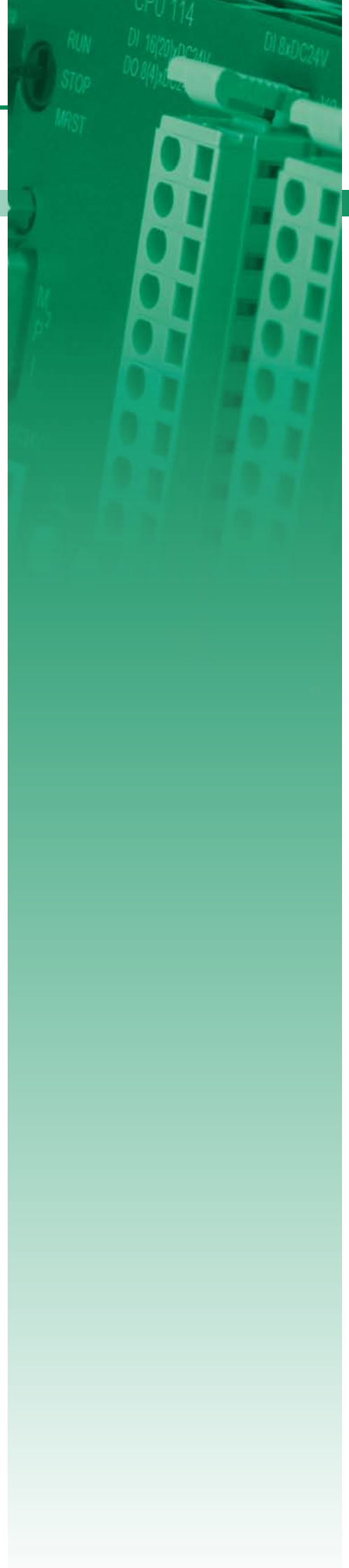

Overview

Order no.	Name/Description	Page
Clamp modules		
101-4FH50	CM 101 - Clamp modules <ul style="list-style-type: none">› 8x11 clamps› passive	192



Clamp modules

Clamp modules Clamp modules						
101-4FH50						

Order number	101-4FH50			
Figure				
Type	CM 101			
General information				
Note	-			
Features	<ul style="list-style-type: none"> ▸ 8x11 clamps ▸ passive 			
Clamp parameter				
Terminal voltage max.	DC 60 V			
Terminal current max.	10 A			
Isolated group				
Number of clamps	11-11-11-11-4*11			
Color of clamps	grey-grey-grey-grey-grey			
Binding of potential	unbound-unbound-unbound-unbound-unbound			
Potential group current, max.	10 A-10 A-10 A-10 A-10 A			
Housing				
Material	PPE / PA 6.6			
Mounting	Profile rail 35 mm			
Mechanical data				
Dimensions (WxHxD)	101.6 mm x 76 mm x 48 mm			
Weight	212 g			
Environmental conditions				
Operating temperature	0 °C to 60 °C			
Storage temperature	-25 °C to 70 °C			
Certifications				
UL508 certification	yes			

Connections, Interfaces

Clamp modules | Clamp modules

101-4FH50						
-----------	--	--	--	--	--	--

101-4FH50

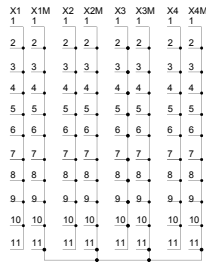

Signal modules digital



Structure and Function

Digital input and output modules acquire the binary control signals from the process level and transform them into interpretable signals for controlling. They convert the internal binary control signals into signals suitable for the process level. With the expansion modules EM 123, the number of inputs/outputs of the CPU 114/115 is expanded. The connection is made to the CPU via 1 tier bus connectors supplied with the module.

Characteristics

- › Up to 32 digital inputs and outputs on an expansion module
- › Combinable with signal modules from the System 200V
- › LED status indicator
- › Maintenance-free cage clamp technology
- › Front connector included
- › Bus connector included
- › Assembly with 35 mm profile rail
- › 24 months warranty

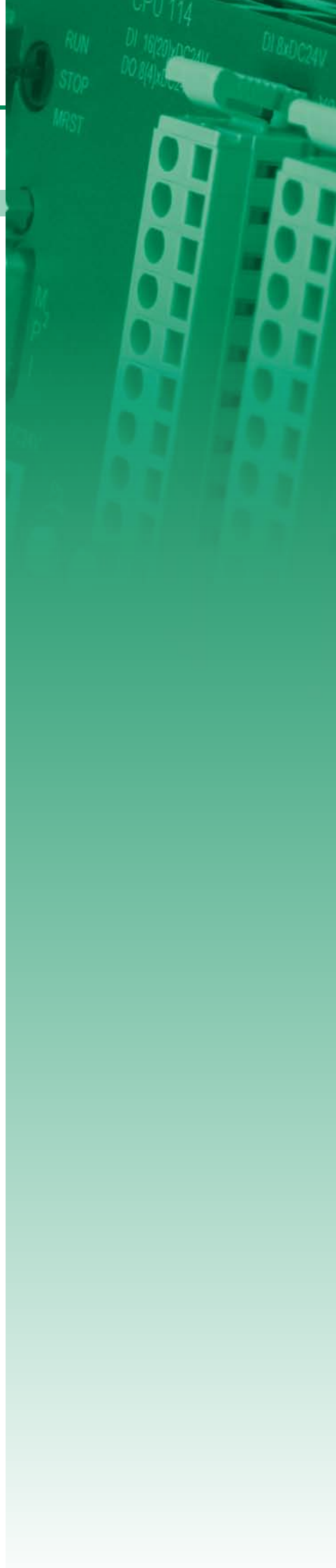



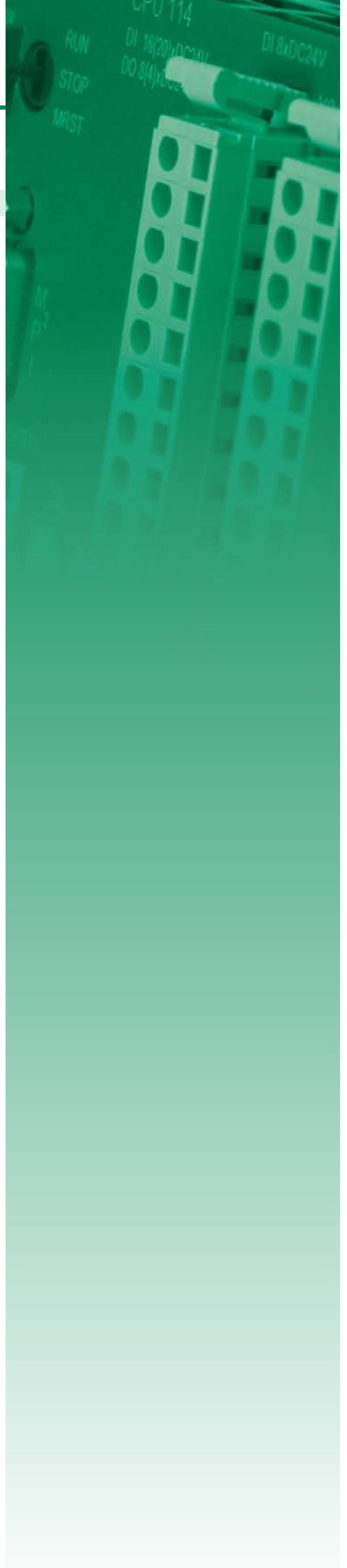

Overview

Order no.	Name/Description	Page
Digital in/output modules		
123-4EH01	EM 123 - Expansion module, digital ▶ 8 inputs/ 8 outputs ▶ DC 24 V	196
123-4EJ01	EM 123 - Expansion module, digital ▶ 16 inputs/ 8 outputs ▶ DC 24 V	196
123-4EJ11	EM 123 - Expansion module, digital ▶ 16 inputs ▶ 8 relay outputs	196
123-4EJ20	EM 123 - Expansion module, digital ▶ 16 inputs ▶ AC/DC 60...230 V ▶ 8 relay outputs	196
123-4EL01	EM 123 - Expansion module, digital ▶ 16 inputs/ 16 outputs ▶ Isolated	200



Digital in/output modules

Signal modules digital Digital in/output modules					
123-4EH01	123-4EL01				
123-4EJ01					
123-4EJ11					
123-4EJ20					

Order number	123-4EH01	123-4EJ01	123-4EJ11	123-4EJ20
Figure				
Type	EM 123	EM 123	EM 123	EM 123
General information				
Note	-	-	-	-
Features	<ul style="list-style-type: none"> ▶ 8 inputs/ 8 outputs ▶ DC 24 V 	<ul style="list-style-type: none"> ▶ 16 inputs/ 8 outputs ▶ DC 24 V 	<ul style="list-style-type: none"> ▶ 16 inputs ▶ 8 relay outputs 	<ul style="list-style-type: none"> ▶ 16 inputs ▶ AC/DC 60...230 V ▶ 8 relay outputs
Current consumption/power loss				
Current consumption from backplane bus	60 mA	70 mA	300 mA	320 mA
Power loss	3 W	4.5 W	4.5 W	4.6 W
Technical data digital inputs				
Number of inputs	8	16	16	16
Cable length, shielded	1000 m	1000 m	1000 m	1000 m
Cable length, unshielded	600 m	600 m	600 m	600 m
Rated load voltage	-	-	-	-
Current consumption from load voltage L+ (without load)	-	-	-	-
Rated value	DC 24 V	DC 24 V	DC 24 V	AC/DC 60...230 V
Input voltage for signal "0"	DC 0...5 V	DC 0...5 V	DC 0...5 V	AC/DC 0...35 V
Input voltage for signal "1"	DC 15...28.8 V	DC 15...28.8 V	DC 15...28.8 V	AC/DC 60...230 V
Input voltage hysteresis	-	-	-	-
Frequency range	-	-	-	-
Input resistance	-	-	-	-
Input current for signal "1"	7 mA	7 mA	7 mA	2 mA
Connection of Two-Wire-BEROs possible	✓	✓	✓	-
Max. permissible BERO quiescent current	1.5 mA	1.5 mA	1.5 mA	-
Input delay of "0" to "1"	3 ms	3 ms	3 ms	25 ms
Input delay of "1" to "0"	3 ms	3 ms	3 ms	25 ms
Number of simultaneously utilizable inputs horizontal configuration	8	16	16	16
Number of simultaneously utilizable inputs vertical configuration	8	16	16	16
Input characteristic curve	IEC 61131-2, type 1	IEC 61131-2, type 1	IEC 61131-2, type 1	-
Initial data size	1 Byte	2 Byte	2 Byte	2 Byte
Technical data digital outputs				
Number of outputs	8	8	8	8
Cable length, shielded	1000 m	1000 m	1000 m	1000 m
Cable length, unshielded	600 m	600 m	600 m	600 m
Rated load voltage	DC 24 V	DC 24 V	DC 30 V/ AC 230 V	DC 30 V/ AC 230 V
Reverse polarity protection of rated load voltage	-	-	-	-
Current consumption from load voltage L+ (without load)	20 mA	20 mA	-	-

Signal modules digital Digital in/output modules					
123-4EH01	123-4EL01				
123-4EJ01					
123-4EJ11					
123-4EJ20					

Order number	123-4EH01	123-4EJ01	123-4EJ11	123-4EJ20
Output current at signal "1", rated value	0.5 A	0.5 A	5 A	5 A
Output delay of "0" to "1"	max. 100 µs	max. 100 µs	10 ms	6 ms
Output delay of "1" to "0"	max. 350 µs	max. 350 µs	5 ms	3 ms
Minimum load current	-	-	-	-
Lamp load	5 W	5 W	-	-
Parallel switching of outputs for redundant control of a load	not possible	not possible	not possible	not possible
Parallel switching of outputs for increased power	not possible	not possible	not possible	not possible
Actuation of digital input	✓	✓	-	-
Switching frequency with resistive load	max. 1000 Hz	max. 1000 Hz	max. 10 Hz	max. 10 Hz
Switching frequency with inductive load	max. 0.5 Hz	max. 0.5 Hz	-	-
Switching frequency on lamp load	max. 10 Hz	max. 10 Hz	-	-
Internal limitation of inductive shut-off voltage	L+ (-52 V)	L+ (-52 V)	-	-
Short-circuit protection of output	yes, electronic	yes, electronic	-	-
Trigger level	1 A	1 A	-	-
Number of operating cycle of relay outputs	-	-	10 ⁷	10 ⁷
Switching capacity of contacts	-	-	-	-
Output data size	1 Byte	1 Byte	1 Byte	1 Byte
Status information, alarms, diagnostics				
Status display	green LED per channel	green LED per channel	green LED per channel	green LED per channel
Interrupts	no	no	no	no
Process alarm	no	no	no	no
Diagnostic interrupt	no	no	no	no
Diagnostic functions	no	no	no	no
Diagnostics information read-out	none	none	none	none
Supply voltage display	none	none	none	none
Group error display	none	none	none	none
Channel error display	none	none	none	none
Isolation				
Between channels	-	-	-	-
Between channels of groups to	8	8	8	8
Between channels and backplane bus	✓	✓	✓	✓
Insulation tested with	DC 500 V	DC 500 V	DC 500 V	DC 500 V
Datasizes				
Input bytes	2	2	2	2
Output bytes	2	2	2	2
Parameter bytes	0	0	0	0
Diagnostic bytes	0	0	0	0
Housing				
Material	PPE / PA 6.6	PPE / PA 6.6	PPE / PA 6.6	PPE / PA 6.6
Mounting	Profile rail 35 mm	Profile rail 35 mm	Profile rail 35 mm	Profile rail 35 mm

Signal modules digital Digital in/output modules						
123-4EH01	123-4EL01					
123-4EJ01						
123-4EJ11						
123-4EJ20						

Order number	123-4EH01	123-4EJ01	123-4EJ11	123-4EJ20
Mechanical data				
Dimensions (WxHxD)	101.6 mm x 76 mm x 48 mm	101.6 mm x 76 mm x 48 mm	101.6 mm x 76 mm x 48 mm	101.6 mm x 76 mm x 48 mm
Weight	222 g	226 g	250 g	244 g
Environmental conditions				
Operating temperature	0 °C to 60 °C	0 °C to 60 °C	0 °C to 60 °C	0 °C to 60 °C
Storage temperature	-25 °C to 70 °C	-25 °C to 70 °C	-25 °C to 70 °C	-25 °C to 70 °C
Certifications				
UL508 certification	yes	yes	yes	yes

Connections, Interfaces

Signal modules digital | Digital in/output modules

123-4EH01 123-4EJ01 123-4EJ11 123-4EJ20	123-4EL01				
--	-----------	--	--	--	--

123-4EH01



X1

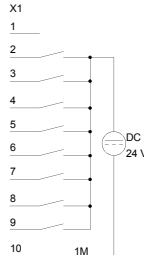

X3

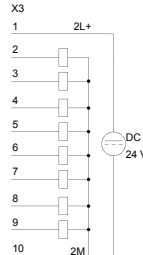

123-4EJ01



X1

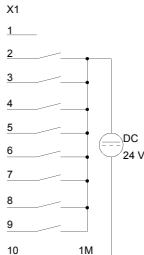

X2

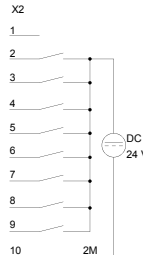

X3

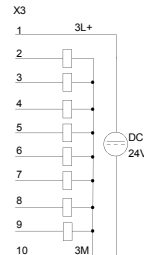

123-4EJ11



X1

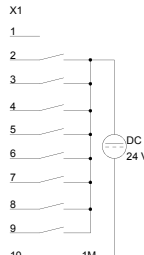

X2

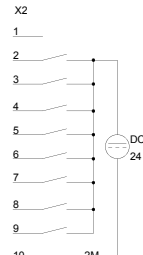

X3

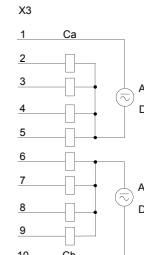

123-4EJ20



X1

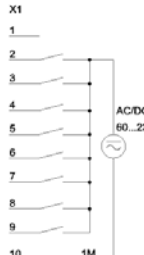

X2

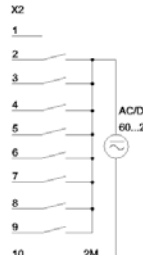

X3

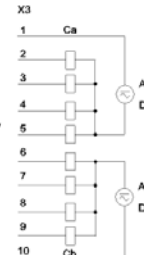

Digital in/output modules

Signal modules digital Digital in/output modules					
123-4EH01	123-4EL01				
123-4EJ01					
123-4EJ11					
123-4EJ20					

Order number	123-4EL01			
Figure				
Type	EM 123			
General information				
Note	-			
Features	<ul style="list-style-type: none"> ▶ 16 inputs/ 16 outputs ▶ Isolated 			
Current consumption/power loss				
Current consumption from backplane bus	110 mA			
Power loss	6 W			
Technical data digital inputs				
Number of inputs	16			
Cable length, shielded	1000 m			
Cable length, unshielded	600 m			
Rated load voltage	-			
Current consumption from load voltage L+ (without load)	-			
Rated value	DC 24 V			
Input voltage for signal "0"	DC 0...5 V			
Input voltage for signal "1"	DC 15...28.8 V			
Input voltage hysteresis	-			
Frequency range	-			
Input resistance	-			
Input current for signal "1"	7 mA			
Connection of Two-Wire-BERs possible	✓			
Max. permissible BERO quiescent current	1.5 mA			
Input delay of "0" to "1"	3 ms			
Input delay of "1" to "0"	3 ms			
Number of simultaneously utilizable inputs horizontal configuration	16			
Number of simultaneously utilizable inputs vertical configuration	16			
Input characteristic curve	IEC 61131-2, type 1			
Initial data size	2 Byte			
Technical data digital outputs				
Number of outputs	16			
Cable length, shielded	1000 m			
Cable length, unshielded	600 m			
Rated load voltage	DC 24 V			
Reverse polarity protection of rated load voltage	-			
Current consumption from load voltage L+ (without load)	30 mA			

Signal modules digital Digital in/output modules						
123-4EH01	123-4EL01					
123-4EJ01						
123-4EJ11						
123-4EJ20						

Order number	123-4EL01			
Output current at signal "1", rated value	0.5 A			
Output delay of "0" to "1"	max. 100 µs			
Output delay of "1" to "0"	max. 350 µs			
Minimum load current	-			
Lamp load	5 W			
Parallel switching of outputs for redundant control of a load	not possible			
Parallel switching of outputs for increased power	not possible			
Actuation of digital input	✓			
Switching frequency with resistive load	max. 1000 Hz			
Switching frequency with inductive load	max. 0.5 Hz			
Switching frequency on lamp load	max. 10 Hz			
Internal limitation of inductive shut-off voltage	L+ (-52 V)			
Short-circuit protection of output	yes, electronic			
Trigger level	1 A			
Number of operating cycle of relay outputs	-			
Switching capacity of contacts	-			
Output data size	2 Byte			
Status information, alarms, diagnostics				
Status display	green LED per channel			
Interrupts	no			
Process alarm	no			
Diagnostic interrupt	no			
Diagnostic functions	no			
Diagnostics information read-out	none			
Supply voltage display	none			
Group error display	none			
Channel error display	none			
Isolation				
Between channels	-			
Between channels of groups to	8			
Between channels and backplane bus	✓			
Insulation tested with	DC 500 V			
Datasizes				
Input bytes	2			
Output bytes	2			
Parameter bytes	0			
Diagnostic bytes	0			
Housing				
Material	PPE / PA 6.6			
Mounting	Profile rail 35 mm			

Signal modules digital Digital in/output modules						
123-4EH01	123-4EL01					
123-4EJ01						
123-4EJ11						
123-4EJ20						

Order number	123-4EL01			
Mechanical data				
Dimensions (WxHxD)	101.6 mm x 76 mm x 48 mm			
Weight	271 g			
Environmental conditions				
Operating temperature	0 °C to 60 °C			
Storage temperature	-25 °C to 70 °C			
Certifications				
UL508 certification	yes			

Connections, Interfaces

Signal modules digital | Digital in/output modules

123-4EH01 123-4EJ01 123-4EJ11 123-4EJ20	123-4EL01				
--	-----------	--	--	--	--

123-4EL01

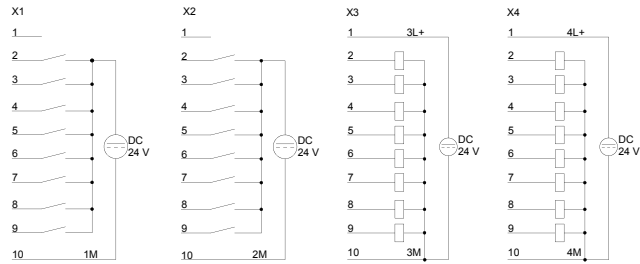

Signal modules analog

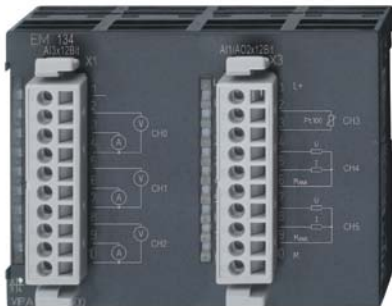

Structure and Function

Analog input/output modules acquire the analog control signals out of the process level and transform them into interpretable signals for controlling. They convert the internal control signals into signals suitable for the process level. With the expansion modules EM 123, the number of inputs/outputs of the CPU 114/115 is expanded. The connection is made to the CPU via 1tier bus connectors supplied with the module.

Characteristics

- › Up to 6 analog inputs and outputs on an expansion module
- › Combinable with signal modules from the system 200V
- › LED status indicator
- › Maintenance-free cage clamp technology
- › Front connector included
- › Bus connector included
- › Assembly with 35 mm profile rail
- › 24 months warranty

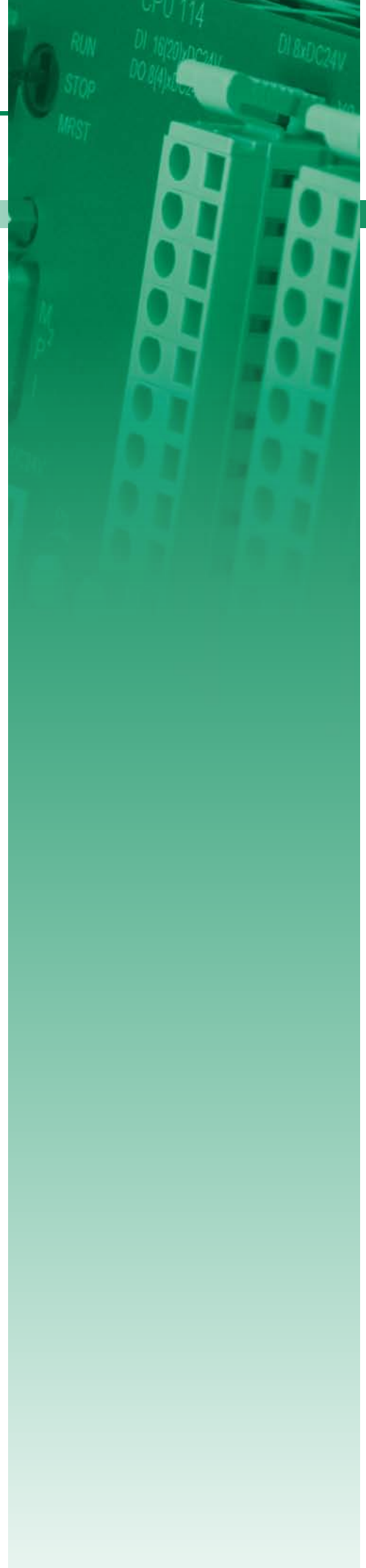

Overview

Order no.	Name/Description	Page
Analog in/output modules		
134-4EE00	EM 134 - Expansion module, analog ▶ 3 inputs U/I ▶ 1 input Pt, Ni, R ▶ 2 outputs U/I ▶ Configurable	206



Analog in/output modules

Signal modules analog Analog in/output modules					
134-4EE00					

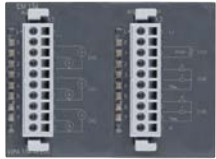
Order number	134-4EE00			
Figure				
Type	EM 134			
General information				
Note	-			
Features	<ul style="list-style-type: none"> ▶ 3 inputs U/I ▶ 1 input Pt, Ni, R ▶ 2 outputs U/I ▶ Configurable 			
Current consumption/power loss				
Current consumption from backplane bus	70 mA			
Power loss	2 W			
Technical data analog inputs				
Number of inputs	4			
Cable length, shielded	-			
Rated load voltage	DC 24 V			
Reverse polarity protection of rated load voltage	✓			
Current consumption from load voltage L+ (without load)	55 mA			
Voltage inputs	✓			
Min. input resistance (voltage range)	120 kΩ			
Input voltage ranges	+1 V ... +5 V 0 V ... +10 V -10 V ... +10 V			
Operational limit of voltage ranges	+/-0.3% ... +/-0.7%			
Operational limit of voltage ranges with SFU	-			
Basic error limit voltage ranges	+/-0.2% ... +/-0.5%			
Basic error limit voltage ranges with SFU	-			
Destruction limit current	-			
Current inputs	✓			
Max. input resistance (current range)	110 Ω			
Input current ranges	+4 mA ... +20 mA -20 mA ... +20 mA 0 mA ... +20 mA			
Operational limit of current ranges	+/-0.3% ... +/-0.8%			
Operational limit of current ranges with SFU	-			
Basic error limit current ranges	+/-0.2% ... +/-0.5%			
Radical error limit current ranges with SFU	-			
Destruction limit current inputs (electrical current)	-			
Destruction limit current inputs (voltage)	-			
Resistance inputs	✓			

Signal modules analog Analog in/output modules						
134-4EE00						

Order number	134-4EE00			
Resistance ranges	0 ... 600 Ohm 0 ... 3000 Ohm			
Operational limit of resistor ranges	+/-0.4%			
Operational limit of resistor ranges with SFU	-			
Basic error limit	+/-0.2%			
Basic error limit with SFU	-			
Destruction limit resistance inputs	-			
Resistance thermometer inputs	✓			
Resistance thermometer ranges	Pt100 Pt1000 Ni100 Ni1000			
Operational limit of resistance thermometer ranges	+/-0.6% ... +/-1.0%			
Operational limit of resistance thermometer ranges with SFU	-			
Basic error limit thermoresistor ranges	+/-0.4% ... +/-0.5%			
Basic error limit thermoresistor ranges with SFU	-			
Destruction limit resistance thermometer inputs	-			
Thermocouple inputs	-			
Thermocouple ranges	-			
Operational limit of thermocouple ranges	-			
Operational limit of thermocouple ranges with SFU	-			
Basic error limit thermoelement ranges	-			
Basic error limit thermoelement ranges with SFU	-			
Destruction limit thermocouple inputs	-			
Programmable temperature compensation	-			
External temperature compensation	-			
Internal temperature compensation	-			
Internal temperature compensation	-			
Technical unit of temperature measurement	-			
Resolution in bit	12			
Measurement principle	successive approximation			
Basic conversion time	3.2 ms / channel			
Noise suppression for frequency	50 Hz, 60 Hz, 400 Hz			
Initial data size	8 Byte			
Technical data analog outputs				
Number of outputs	2			
Cable length, shielded	-			
Rated load voltage	DC 24 V			
Reverse polarity protection of rated load voltage	✓			

Signal modules analog Analog in/output modules					
134-4EE00					

Order number	134-4EE00			
Current consumption from load voltage L+ (without load)	55 mA			
Voltage output short-circuit protection	✓			
Voltage outputs	✓			
Min. load resistance (voltage range)	1 kΩ			
Max. capacitive load (current range)	1 μF			
Max. inductive load (current range)	30 mA			
Output voltage ranges	-10 V ... +10 V +1 V ... +5 V 0 V ... +10 V			
Operational limit of voltage ranges	+/-0.4% ... +/-0.8%			
Basic error limit voltage ranges	+/-0.2% ... +/-0.4%			
Destruction limit against external applied voltage	-			
Current outputs	✓			
Max. in load resistance (current range)	500 Ω			
Max. inductive load (current range)	10 mH			
Max. inductive load (current range)	15 V			
Output current ranges	0 mA ... +20 mA +4 mA ... +20 mA -20 mA ... +20 mA			
Operational limit of current ranges	+/-0.3% ... +/-0.8%			
Basic error limit current ranges	+/-0.2% ... +/-0.5%			
Destruction limit against external applied voltage	-			
Settling time for ohmic load	0.5 ms			
Settling time for capacitive load	1 ms			
Settling time for inductive load	1 ms			
Resolution in bit	12			
Conversion time	1.2 ms / channel			
Substitute value can be applied	yes			
Output data size	4 Byte			
Status information, alarms, diagnostics				
Status display	none			
Interrupts	yes			
Process alarm	no			
Diagnostic interrupt	yes, parameterizable			
Diagnostic functions	yes			
Diagnostics information read-out	possible			
Supply voltage display	green LED			
Group error display	red SF LED			
Channel error display	none			
Isolation				
Between channels	-			
Between channels of groups to	-			
Between channels and backplane bus	✓			
Between channels and power supply	✓			
Max. potential difference between circuits	-			

Signal modules analog Analog in/output modules						
134-4EE00						

Order number	134-4EE00			
Max. potential difference between inputs (Ucm)	DC 11 V			
Max. potential difference between Mana and Mintern (Uiso)	DC 75 V/ AC 60 V			
Max. potential difference between inputs and Mana (Ucm)	DC 11 V			
Max. potential difference between inputs and Mintern (Uiso)	DC 75 V/ AC 60 V			
Max. potential difference between Mintern and outputs	-			
Insulation tested with	DC 500 V			
Datasizes				
Input bytes	8			
Output bytes	4			
Parameter bytes	18			
Diagnostic bytes	12			
Housing				
Material	PPE / PA 6.6			
Mounting	Profile rail 35 mm			
Mechanical data				
Dimensions (WxHxD)	101.6 mm x 76 mm x 48 mm			
Weight	230 g			
Environmental conditions				
Operating temperature	0 °C to 60 °C			
Storage temperature	-25 °C to 70 °C			
Certifications				
UL508 certification	yes			

Connections, Interfaces

Signal modules analog Analog in/output modules					
134-4EE00					

134-4EE00

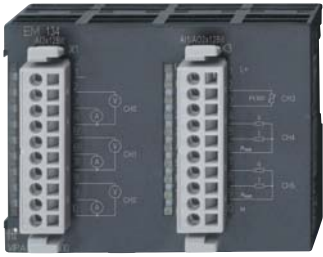

①

X1
AIx12Bit

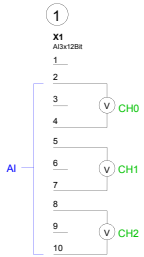

②

X1
AIx12Bit

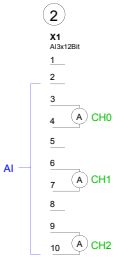

③

X3
AI/AOx12Bit

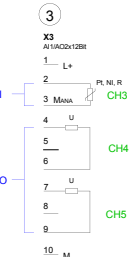

④

X3
AI/AOx12Bit

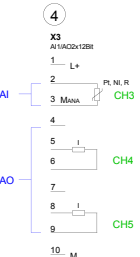

Interface modules

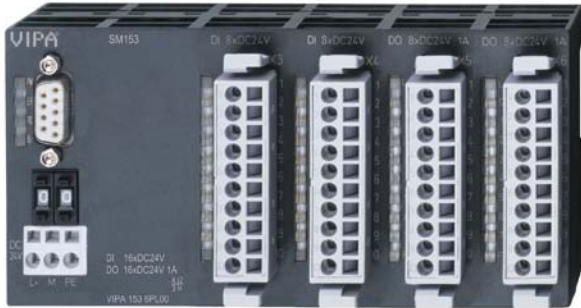

Structure and Function

Fieldbus slave modules for the decentralized expansion of control systems with integrated digital inputs/outputs. The fieldbus slave modules are available in various designs.

Characteristics

- › For PROFIBUS-DP and CANopen
- › Up to 125 DP slaves to a DP master
- › LED status indicator
- › Maintenance-free cage clamp technology
- › Front connector included
- › Bus connector included
- › Assembly with 35 mm profile rail
- › 24 months warranty

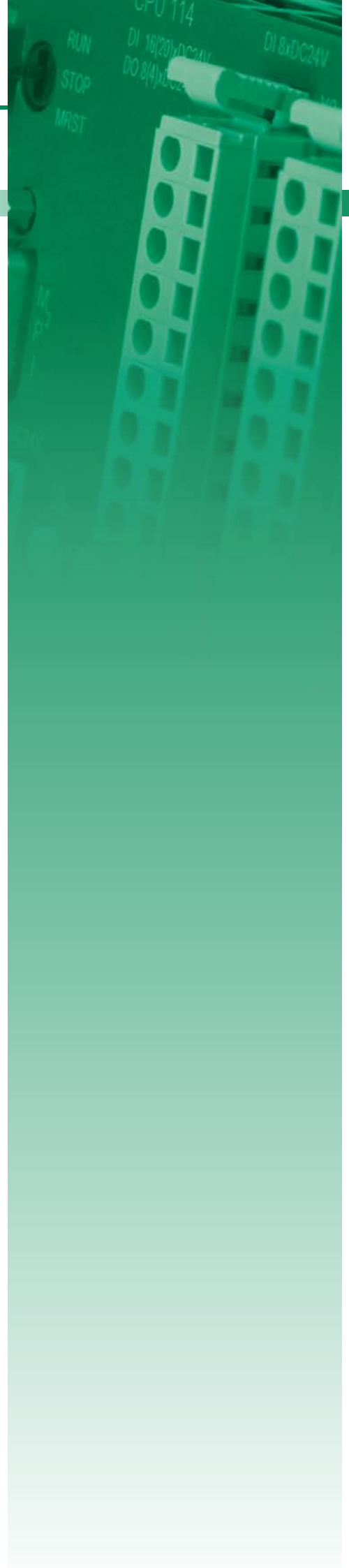

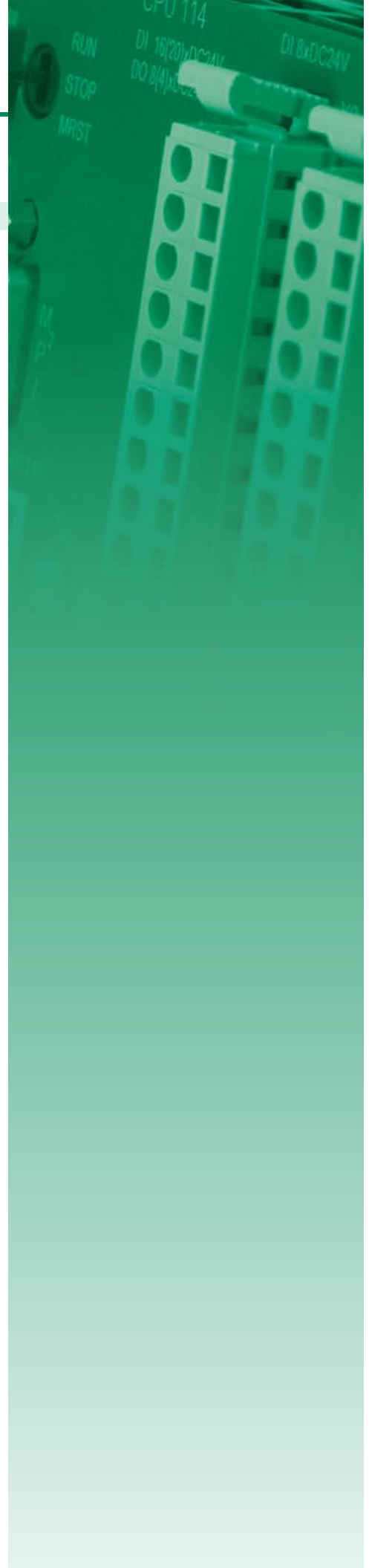

Overview

Order no.	Name/Description	Page
Fieldbus slave modules with I/Os, DI		
151-4PH00	SM 151 - PROFIBUS-DP slave, digital ‣ PROFIBUS-DP slave ‣ 16 inputs	214
151-6PH00	SM 151 - PROFIBUS-DP slave, digital ‣ PROFIBUS-DP slave ‣ 16 inputs ‣ 4x11 clamps	214
151-6PL00	SM 151 - PROFIBUS-DP slave, digital ‣ PROFIBUS-DP slave ‣ 32 inputs	214
Fieldbus slave modules with I/Os, DO		
152-4PH00	SM 152 - PROFIBUS-DP slave, digital ‣ PROFIBUS-DP slave ‣ 16 outputs	218
152-6PH00	SM 152 - PROFIBUS-DP slave, digital ‣ PROFIBUS-DP slave ‣ 16 outputs ‣ 4x11 clamps	218
152-6PH50	SM 152 - PROFIBUS-DP slave, digital ‣ PROFIBUS-DP slave ‣ 16 relay outputs	218
152-6PL00	SM 152 - PROFIBUS-DP slave, digital ‣ PROFIBUS-DP slave ‣ 32 outputs	218
Fieldbus slave modules with I/Os, DIO		
153-4CF00	SM 153 - CANopen slave, digital ‣ CAN slave ‣ 8 channels as inputs or outputs ‣ 2x11 clamps	222
153-4CH00	SM 153 - CANopen slave, digital ‣ CAN slave ‣ 8 (12) inputs ‣ 4 (8) outputs	222
153-4PF00	SM 153 - PROFIBUS-DP slave, digital ‣ PROFIBUS-DP slave ‣ 8 channels as inputs or outputs ‣ 2x11 clamps	222
153-4PH00	SM 153 - PROFIBUS-DP slave, digital ‣ PROFIBUS-DP slave ‣ 8 inputs ‣ 8 outputs	222
153-6CH00	SM 153 - CANopen slave, digital ‣ CAN slave ‣ 8 (12) inputs ‣ 4 (8) outputs ‣ 4x11 clamps	227
153-6CL10	SM 153 - CANopen slave, digital ‣ CAN slave ‣ 24 inputs ‣ 8 outputs	227
153-6PH00	SM 153 - PROFIBUS-DP slave, digital ‣ PROFIBUS-DP slave ‣ 8 inputs ‣ 8 outputs ‣ 4x11 clamps	227
153-6PL00	SM 153 - PROFIBUS-DP slave, digital ‣ PROFIBUS-DP slave ‣ 16 inputs ‣ 16 outputs	227
153-6PL10	SM 153 - PROFIBUS-DP slave, digital ‣ PROFIBUS-DP slave ‣ 24 inputs ‣ 8 outputs	232



Fieldbus slave modules with I/Os, DI

Interface modules Fieldbus slave modules with I/Os, DI						
151-4PH00						
151-6PH00						
151-6PL00						

Order number	151-4PH00	151-6PH00	151-6PL00	
Figure				
Type	SM 151	SM 151	SM 151	
General information				
Note	-	-	-	
Features	<ul style="list-style-type: none"> ▸ PROFIBUS-DP slave ▸ 16 inputs 	<ul style="list-style-type: none"> ▸ PROFIBUS-DP slave ▸ 16 inputs ▸ 4x11 clamps 	<ul style="list-style-type: none"> ▸ PROFIBUS-DP slave ▸ 32 inputs 	
Technical data power supply				
Power supply (rated value)	DC 24 V	DC 24 V	DC 24 V	
Power supply (permitted range)	DC 20.4...28.8 V	DC 20.4...28.8 V	DC 20.4...28.8 V	
Reverse polarity protection	✓	✓	✓	
Current consumption (no-load operation)	-	-	-	
Current consumption (rated value)	55 mA	55 mA	55 mA	
Inrush current	40 A	40 A	40 A	
I ² t	0.15 A ² s	0.15 A ² s	0.15 A ² s	
Technical data digital inputs				
Number of inputs	16	16	32	
Cable length, shielded	1000 m	1000 m	1000 m	
Cable length, unshielded	600 m	600 m	600 m	
Rated load voltage	DC 24 V	DC 24 V	DC 24 V	
Reverse polarity protection of rated load voltage	-	-	-	
Current consumption from load voltage L+ (without load)	-	-	-	
Rated value	DC 24 V	DC 24 V	DC 24 V	
Input voltage for signal "0"	DC 0...5 V	DC 0...5 V	DC 0...5 V	
Input voltage for signal "1"	DC 15...28.8 V	DC 15...28.8 V	DC 15...28.8 V	
Input voltage hysteresis	-	-	-	
Frequency range	-	-	-	
Input resistance	-	-	-	
Input current for signal "1"	7 mA	7 mA	7 mA	
Connection of Two-Wire-BEROs possible	✓	✓	✓	
Max. permissible BERO quiescent current	1.5 mA	1.5 mA	1.5 mA	
Input delay of "0" to "1"	3 ms	3 ms	3 ms	
Input delay of "1" to "0"	3 ms	3 ms	3 ms	
Number of simultaneously utilizable inputs horizontal configuration	16	16	32	
Number of simultaneously utilizable inputs vertical configuration	16	16	32	
Input characteristic curve	IEC 61131-2, type 1	IEC 61131-2, type 1	IEC 61131-2, type 1	
Initial data size	2 Byte	2 Byte	4 Byte	

SLIO
100V
200V
300S
500S
HMI
Teleservice
StarterKits
Safety
Solutions
Software
Accessories
Appendix
214

Interface modules Fieldbus slave modules with I/Os, DI						
151-4PH00						
151-6PH00						
151-6PL00						

Order number	151-4PH00	151-6PH00	151-6PL00	
Status information, alarms, diagnostics				
Status display	green LED per channel	green LED per channel	green LED per channel	
Interrupts	no	no	no	
Process alarm	no	no	no	
Diagnostic interrupt	no	no	no	
Diagnostic functions	no	no	no	
Diagnostics information read-out	possible	possible	possible	
Supply voltage display	yes	yes	yes	
Group error display	red SF LED	red SF LED	red SF LED	
Channel error display	none	none	none	
Isolation				
Between channels	-	-	-	
Between channels of groups to	-	-	-	
Between channels and backplane bus	-	-	-	
Between channels and power supply	-	-	-	
Max. potential difference between circuits	-	-	-	
Max. potential difference between inputs (Ucm)	-	-	-	
Max. potential difference between Mana and Mintern (Uiso)	-	-	-	
Max. potential difference between inputs and Mana (Ucm)	-	-	-	
Max. potential difference between inputs and Mintern (Uiso)	-	-	-	
Max. potential difference between Mintern and outputs	-	-	-	
Insulation tested with	DC 500 V	DC 500 V	DC 500 V	
Hardware configuration				
Racks, max.	-	-	-	
Modules per rack, max.	-	-	-	
Number of digital modules, max.	-	-	-	
Number of analog modules, max.	-	-	-	
Communication				
Fieldbus	PROFIBUS-DP to EN 50170	PROFIBUS-DP to EN 50170	PROFIBUS-DP to EN 50170	
Type of interface	RS485	RS485	RS485	
Connector	Sub-D, 9-pin, female	Sub-D, 9-pin, female	Sub-D, 9-pin, female	
Topology	Linear bus with bus termination at both ends	Linear bus with bus termination at both ends	Linear bus with bus termination at both ends	
Electrically isolated	✓	✓	✓	
Number of participants, max.	125	125	125	
Node addresses	1 - 99	1 - 99	1 - 99	
Transmission speed, min.	9.6 kbit/s	9.6 kbit/s	9.6 kbit/s	
Transmission speed, max.	12 Mbit/s	12 Mbit/s	12 Mbit/s	
Address range inputs, max.	2 Byte	2 Byte	4 Byte	
Address range outputs, max.	0 Byte	0 Byte	0 Byte	
Number of TxPDOs, max.	-	-	-	
Number of RxPDOs, max.	-	-	-	

Interface modules Fieldbus slave modules with I/Os, DI						
151-4PH00						
151-6PH00						
151-6PL00						

Order number	151-4PH00	151-6PH00	151-6PL00	
Datasizes				
Input bytes	1	2	4	
Output bytes	0	0	0	
Parameter bytes	7 + 5	7 + 5	7 + 5	
Diagnostic bytes	0	0	0	
Housing				
Material	PPE / PA 6.6	PPE / PA 6.6	PPE / PA 6.6	
Mounting	Profile rail 35 mm	Profile rail 35 mm	Profile rail 35 mm	
Mechanical data				
Dimensions (WxHxD)	101.6 mm x 76 mm x 48 mm	152.4 mm x 76 mm x 48 mm	152.4 mm x 76 mm x 48 mm	
Weight	217 g	288 g	260 g	
Environmental conditions				
Operating temperature	0 °C to 60 °C	0 °C to 60 °C	0 °C to 60 °C	
Storage temperature	-25 °C to 70 °C	-25 °C to 70 °C	-25 °C to 70 °C	
Certifications				
UL508 certification	yes	yes	yes	

Connections, Interfaces

Interface modules | Fieldbus slave modules with I/Os, DI

151-4PH00
151-6PH00
151-6PL00

151-4PH00

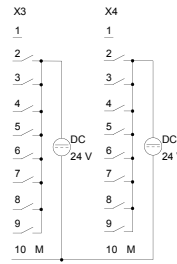
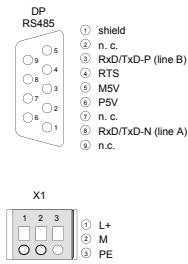
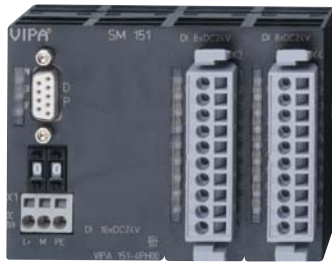

151-6PH00

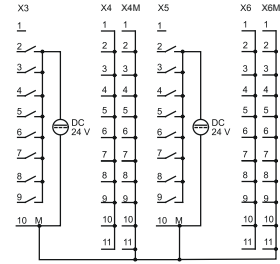
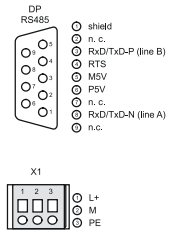



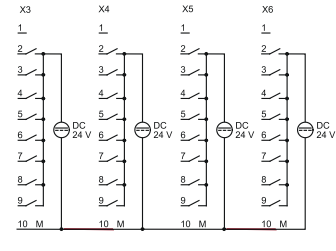
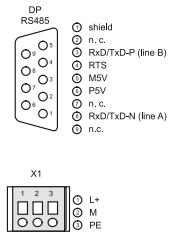

151-6PL00



SLIO
100V
200V
300S
500S
HMI
Teleservice
StarterKits
Safety
Solutions
Software
Accessories
Appendix

Fieldbus slave modules with I/Os, DO

Interface modules Fieldbus slave modules with I/Os, DO					
152-4PH00					
152-6PH00					
152-6PH50					
152-6PL00					

Order number	152-4PH00	152-6PH00	152-6PH50	152-6PL00
Figure				
Type	SM 152	SM 152	SM 152	SM 152
General information				
Note	-	-	-	-
Features	<ul style="list-style-type: none"> ▸ PROFIBUS-DP slave ▸ 16 outputs 	<ul style="list-style-type: none"> ▸ PROFIBUS-DP slave ▸ 16 outputs ▸ 4x11 clamps 	<ul style="list-style-type: none"> ▸ PROFIBUS-DP slave ▸ 16 relay outputs 	<ul style="list-style-type: none"> ▸ PROFIBUS-DP slave ▸ 32 outputs
Technical data power supply				
Power supply (rated value)	DC 24 V	DC 24 V	DC 24 V	DC 24 V
Power supply (permitted range)	DC 20.4...28.8 V	DC 20.4...28.8 V	DC 20.4...28.8 V	DC 20.4...28.8 V
Reverse polarity protection	✓	✓	✓	✓
Current consumption (no-load operation)	-	-	-	-
Current consumption (rated value)	55 mA	55 mA	200 mA	55 mA
Technical data digital outputs				
Number of outputs	16	16	16	32
Cable length, shielded	1000 m	1000 m	1000 m	1000 m
Cable length, unshielded	600 m	600 m	600 m	600 m
Rated load voltage	DC 24 V	DC 24 V	DC 30 V/ AC 230 V	DC 24 V
Reverse polarity protection of rated load voltage	-	-	-	-
Current consumption from load voltage L+ (without load)	50 mA	50 mA	-	50 mA
Total current per group, horizontal configuration, 40°C	4 A	4 A	8 A	4 A
Total current per group, horizontal configuration, 60°C	2 A	2 A	8 A	2 A
Total current per group, vertical configuration	2 A	2 A	8 A	2 A
Output voltage signal "1" at min. current	L+ (-0.8 V)	L+ (-0.8 V)	-	L+ (-0.8 V)
Output voltage signal "1" at max. current	L+ (-1.5 V)	L+ (-1.5 V)	-	L+ (-1.5 V)
Output current at signal "1", rated value	1 A	1 A	5 A	1 A
Output delay of "0" to "1"	150 µs	150 µs	-	150 µs
Output delay of "1" to "0"	100 µs	100 µs	-	100 µs
Minimum load current	-	-	-	-
Lamp load	5 W	5 W	-	5 W
Parallel switching of outputs for redundant control of a load	not possible	not possible	-	not possible
Parallel switching of outputs for increased power	not possible	not possible	-	not possible
Actuation of digital input	✓	✓	-	✓
Switching frequency with resistive load	max. 1000 Hz	max. 1000 Hz	max. 100 Hz	max. 1000 Hz
Switching frequency with inductive load	max. 0.5 Hz	max. 0.5 Hz	-	max. 0.5 Hz
Switching frequency on lamp load	max. 10 Hz	max. 10 Hz	-	max. 10 Hz

Interface modules Fieldbus slave modules with I/Os, DO						
152-4PH00						
152-6PH00						
152-6PH50						
152-6PL00						

Order number	152-4PH00	152-6PH00	152-6PH50	152-6PL00
Internal limitation of inductive shut-off voltage	L+ (-52 V)	L+ (-52 V)	-	L+ (-52 V)
Short-circuit protection of output	yes, electronic	yes, electronic	-	yes, electronic
Trigger level	1.5 A	1.5 A	-	1.5 A
Number of operating cycle of relay outputs	-	-	-	-
Switching capacity of contacts	-	-	-	-
Output data size	2 Byte	2 Byte	2 Byte	4 Byte
Status information, alarms, diagnostics				
Status display	green LED per channel	green LED per channel	green LED per channel	green LED per channel
Interrupts	no	no	no	no
Process alarm	no	no	no	no
Diagnostic interrupt	no	no	no	no
Diagnostic functions	no	no	no	no
Diagnostics information read-out	none	none	none	none
Supply voltage display	yes	yes	yes	yes
Group error display	red SF LED	red SF LED	red SF LED	red SF LED
Channel error display	none	none	none	none
Isolation				
Between channels	-	-	-	-
Between channels of groups to	-	-	8	-
Between channels and backplane bus	-	-	✓	-
Between channels and power supply	-	-	-	-
Max. potential difference between circuits	-	-	-	-
Max. potential difference between inputs (U _{cm})	-	-	-	-
Max. potential difference between Mana and Mintern (U _{iso})	-	-	-	-
Max. potential difference between inputs and Mana (U _{cm})	-	-	-	-
Max. potential difference between inputs and Mintern (U _{iso})	-	-	-	-
Max. potential difference between Mintern and outputs	-	-	-	-
Insulation tested with	DC 500 V	DC 500 V	DC 500 V	DC 500 V
Hardware configuration				
Racks, max.	-	-	-	-
Modules per rack, max.	-	-	-	-
Number of digital modules, max.	-	-	-	-
Number of analog modules, max.	-	-	-	-
Communication				
Fieldbus	PROFIBUS-DP to EN 50170	PROFIBUS-DP to EN 50170	PROFIBUS-DP to EN 50170	PROFIBUS-DP to EN 50170
Type of interface	RS485	RS485	RS485	RS485
Connector	Sub-D, 9-pin, female	Sub-D, 9-pin, female	Sub-D, 9-pin, female	Sub-D, 9-pin, female
Topology	Linear bus with bus termination at both ends	Linear bus with bus termination at both ends	Linear bus with bus termination at both ends	Linear bus with bus termination at both ends
Electrically isolated	✓	✓	✓	✓
Number of participants, max.	125	125	125	125

Interface modules Fieldbus slave modules with I/Os, DO						
152-4PH00						
152-6PH00						
152-6PH50						
152-6PL00						

Order number	152-4PH00	152-6PH00	152-6PH50	152-6PL00
Node addresses	1 - 99	1 - 99	1 - 99	1 - 99
Transmission speed, min.	9.6 kbit/s	9.6 kbit/s	9.6 kbit/s	9.6 kbit/s
Transmission speed, max.	12 Mbit/s	12 Mbit/s	12 Mbit/s	12 Mbit/s
Address range inputs, max.	0 Byte	0 Byte	0 Byte	0 Byte
Address range outputs, max.	2 Byte	2 Byte	2 Byte	4 Byte
Number of TxPDOs, max.	-	-	-	-
Number of RxPDOs, max.	-	-	-	-
Datasizes				
Input bytes	0	0	0	0
Output bytes	2	2	2	4
Parameter bytes	7 + 5	7 + 5	7 + 5	7 + 5
Diagnostic bytes	13	13	13	13
Housing				
Material	PPE / PA 6.6	PPE / PA 6.6	PPE / PA 6.6	PPE / PA 6.6
Mounting	Profile rail 35 mm	Profile rail 35 mm	Profile rail 35 mm	Profile rail 35 mm
Mechanical data				
Dimensions (WxHxD)	101.6 mm x 76 mm x 48 mm	152.4 mm x 76 mm x 48 mm	152.4 mm x 76 mm x 48 mm	152.4 mm x 76 mm x 48 mm
Weight	206 g	268 g	310 g	299 g
Environmental conditions				
Operating temperature	0 °C to 60 °C	0 °C to 60 °C	0 °C to 60 °C	0 °C to 60 °C
Storage temperature	-25 °C to 70 °C	-25 °C to 70 °C	-25 °C to 70 °C	-25 °C to 70 °C
Certifications				
UL508 certification	yes	yes	yes	yes

Connections, Interfaces

Interface modules | Fieldbus slave modules with I/Os, DO

- 152-4PH00
- 152-6PH00
- 152-6PH50
- 152-6PL00

152-4PH00

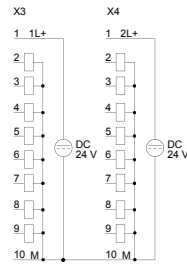
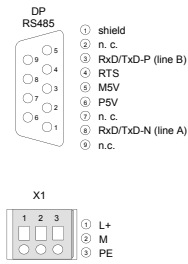
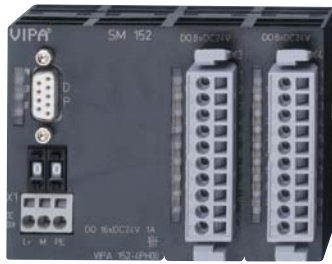

152-6PH00

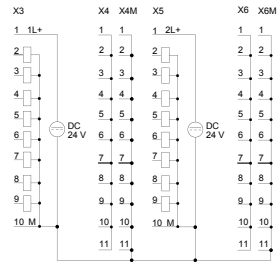
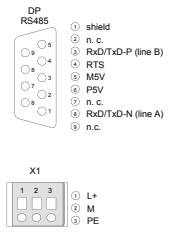

152-6PH50

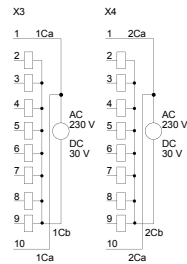
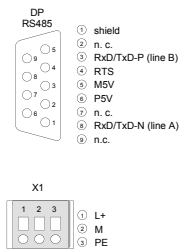
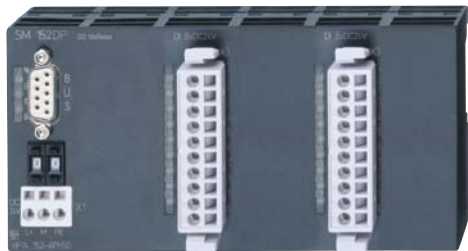

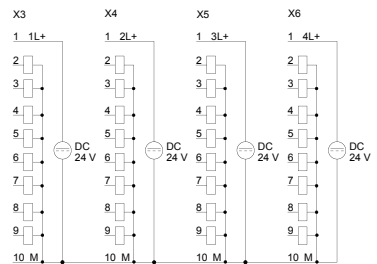
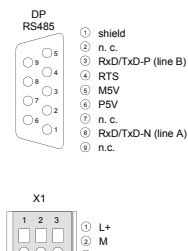

152-6PL00

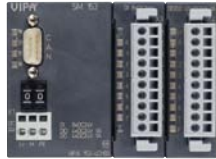

Fieldbus slave modules with I/Os, DIO

Interface modules Fieldbus slave modules with I/Os, DIO					
153-4CF00	153-6CH00	153-6PL10			
153-4CH00	153-6CL10				
153-4PF00	153-6PH00				
153-4PH00	153-6PL00				

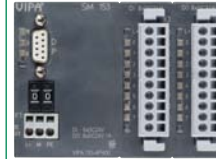
Order number	153-4CF00	153-4CH00	153-4PF00	153-4PH00
Figure				
Type	SM 153, CANopen slave	SM 153, CANopen slave	SM 153, PB-DP slave	SM 153, PB-DP slave
General information				
Note	-	-	-	-
Features	<ul style="list-style-type: none"> ▶ CAN slave ▶ 8 channels as inputs or outputs ▶ 2x11 clamps 	<ul style="list-style-type: none"> ▶ CAN slave ▶ 8 (12) inputs ▶ 4 (8) outputs 	<ul style="list-style-type: none"> ▶ PROFIBUS-DP slave ▶ 8 channels as inputs or outputs ▶ 2x11 clamps 	<ul style="list-style-type: none"> ▶ PROFIBUS-DP slave ▶ 8 inputs ▶ 8 outputs
Technical data power supply				
Power supply (rated value)	DC 24 V	DC 24 V	DC 24 V	DC 24 V
Power supply (permitted range)	DC 20.4...28.8 V	DC 20.4...28.8 V	DC 20.4...28.8 V	DC 20.4...28.8 V
Reverse polarity protection	✓	✓	✓	✓
Current consumption (no-load operation)	-	-	-	-
Current consumption (rated value)	55 mA	55 mA	55 mA	55 mA
Technical data digital inputs				
Number of inputs	0 (8)	8 (12)	0 (8)	8 (16)
Cable length, shielded	1000 m	1000 m	1000 m	1000 m
Cable length, unshielded	600 m	600 m	600 m	600 m
Rated load voltage	DC 24 V	DC 24 V	DC 24 V	DC 24 V
Reverse polarity protection of rated load voltage	-	-	-	-
Current consumption from load voltage L+ (without load)	-	-	-	-
Rated value	DC 24 V	DC 24 V	DC 24 V	DC 24 V
Input voltage for signal "0"	DC 0...5 V	DC 0...5 V	DC 0...5 V	DC 0...5 V
Input voltage for signal "1"	DC 15...28.8 V	DC 15...28.8 V	DC 15...28.8 V	DC 15...28.8 V
Input voltage hysteresis	-	-	-	-
Frequency range	-	-	-	-
Input resistance	-	-	-	-
Input current for signal "1"	7 mA	7 mA	7 mA	7 mA
Connection of Two-Wire-BEROs possible	✓	✓	✓	✓
Max. permissible BERO quiescent current	1.5 mA	1.5 mA	1.5 mA	1.5 mA
Input delay of "0" to "1"	3 ms	3 ms	3 ms	3 ms
Input delay of "1" to "0"	3 ms	3 ms	3 ms	3 ms
Number of simultaneously utilizable inputs horizontal configuration	8	12	8	8
Number of simultaneously utilizable inputs vertical configuration	8	12	8	8
Input characteristic curve	IEC 61131-2, type 1	IEC 61131-2, type 1	IEC 61131-2, type 1	IEC 61131-2, type 1
Initial data size	1 Byte	2 Byte	1 Byte	1 Byte

SLIO
100V
200V
300S
500S
HMI
Teleservice
StarterKits
Safety
Solutions
Software
Accessories
Appendix

Interface modules Fieldbus slave modules with I/Os, DIO					
153-4CF00	153-6CH00	153-6PL10			
153-4CH00	153-6CL10				
153-4PF00	153-6PH00				
153-4PH00	153-6PL00				

Order number	153-4CF00	153-4CH00	153-4PF00	153-4PH00
Technical data digital outputs				
Number of outputs	8 (0)	8 (4)	8 (0)	8 (4)
Cable length, shielded	1000 m	1000 m	1000 m	1000 m
Cable length, unshielded	600 m	600 m	600 m	600 m
Rated load voltage	DC 24 V	DC 24 V	DC 24 V	DC 24 V
Reverse polarity protection of rated load voltage	-	-	-	-
Current consumption from load voltage L+ (without load)	50 mA	50 mA	50 mA	50 mA
Total current per group, horizontal configuration, 40°C	4 A	4 A	4 A	4 A
Total current per group, horizontal configuration, 60°C	2 A	2 A	2 A	2 A
Total current per group, vertical configuration	2 A	2 A	2 A	2 A
Output voltage signal "1" at min. current	L+ (-0.8 V)	L+ (-0.8 V)	L+ (-0.8 V)	L+ (-0.8 V)
Output voltage signal "1" at max. current	L+ (-1.5 V)	L+ (-1.5 V)	L+ (-1.5 V)	L+ (-1.5 V)
Output current at signal "1", rated value	1 A	1 A	1 A	1 A
Output delay of "0" to "1"	150 µs	150 µs	150 µs	150 µs
Output delay of "1" to "0"	100 µs	100 µs	100 µs	100 µs
Minimum load current	-	-	-	-
Lamp load	5 W	5 W	5 W	5 W
Parallel switching of outputs for redundant control of a load	not possible	not possible	not possible	not possible
Parallel switching of outputs for increased power	not possible	not possible	not possible	not possible
Actuation of digital input	✓	✓	✓	✓
Switching frequency with resistive load	max. 1000 Hz	max. 1000 Hz	max. 1000 Hz	max. 1000 Hz
Switching frequency with inductive load	max. 0.5 Hz	max. 0.5 Hz	max. 0.5 Hz	max. 0.5 Hz
Switching frequency on lamp load	max. 10 Hz	max. 10 Hz	max. 10 Hz	max. 10 Hz
Internal limitation of inductive shut-off voltage	L+ (-52 V)	L+ (-52 V)	L+ (-52 V)	L+ (-52 V)
Short-circuit protection of output	yes, electronic	yes, electronic	yes, electronic	yes, electronic
Trigger level	1.5 A	1.5 A	1.5 A	1.5 A
Number of operating cycle of relay outputs	-	-	-	-
Switching capacity of contacts	-	-	-	-
Output data size	1 Byte	1 Byte	1 Byte	1 Byte
Status information, alarms, diagnostics				
Status display	green LED per channel	green LED per channel	green LED per channel	green LED per channel
Interrupts	no	no	no	no
Process alarm	no	no	no	no
Diagnostic interrupt	no	no	no	no
Diagnostic functions	no	no	no	no
Diagnostics information read-out	possible	possible	possible	possible
Supply voltage display	yes	yes	yes	yes
Group error display	red SF LED	red SF LED	red SF LED	red SF LED
Channel error display	none	none	none	none

Interface modules Fieldbus slave modules with I/Os, DIO					
153-4CF00	153-6CH00	153-6PL10			
153-4CH00	153-6CL10				
153-4PF00	153-6PH00				
153-4PH00	153-6PL00				

Order number	153-4CF00	153-4CH00	153-4PF00	153-4PH00
Isolation				
Between channels	-	-	-	-
Between channels of groups to	-	-	-	-
Between channels and backplane bus	-	-	-	-
Between channels and power supply	-	-	-	-
Max. potential difference between circuits	-	-	-	-
Max. potential difference between inputs (Ucm)	-	-	-	-
Max. potential difference between Mana and Mintern (Uiso)	-	-	-	-
Max. potential difference between inputs and Mana (Ucm)	-	-	-	-
Max. potential difference between inputs and Mintern (Uiso)	-	-	-	-
Max. potential difference between Mintern and outputs	-	-	-	-
Insulation tested with	DC 500 V	DC 500 V	DC 500 V	DC 500 V
Hardware configuration				
Racks, max.	-	-	-	-
Modules per rack, max.	-	-	-	-
Number of digital modules, max.	-	-	-	-
Number of analog modules, max.	-	-	-	-
Communication				
Fieldbus	CANopen	CANopen	PROFIBUS-DP to EN 50170	PROFIBUS-DP to EN 50170
Type of interface	CAN	CAN	RS485	RS485
Connector	Sub-D, 9-pin, male	Sub-D, 9-pin, male	Sub-D, 9-pin, female	Sub-D, 9-pin, female
Topology	Linear bus with bus termination at both ends	Linear bus with bus termination at both ends	Linear bus with bus termination at both ends	Linear bus with bus termination at both ends
Electrically isolated	✓	✓	✓	✓
Number of participants, max.	126	126	125	125
Node addresses	1 - 99	1 - 99	1 - 99	1 - 99
Transmission speed, min.	10 kbit/s	10 kbit/s	9.6 kbit/s	9.6 kbit/s
Transmission speed, max.	1 Mbit/s	1 Mbit/s	12 Mbit/s	12 Mbit/s
Address range inputs, max.	1 Byte	2 Byte	1 Byte	1 Byte
Address range outputs, max.	1 Byte	1 Byte	1 Byte	1 Byte
Number of TxPDOs, max.	1	1	-	-
Number of RxPDOs, max.	1	1	-	-
Datasizes				
Input bytes	1	2	1	1
Output bytes	1	1	1	1
Parameter bytes	-	-	7 + 5	7 + 5
Diagnostic bytes	-	-	13	13

Interface modules Fieldbus slave modules with I/Os, DIO						
153-4CF00	153-6CH00	153-6PL10				
153-4CH00	153-6CL10					
153-4PF00	153-6PH00					
153-4PH00	153-6PL00					

Order number	153-4CF00	153-4CH00	153-4PF00	153-4PH00
Housing				
Material	PPE / PA 6.6	PPE / PA 6.6	PPE / PA 6.6	PPE / PA 6.6
Mounting	Profile rail 35 mm	Profile rail 35 mm	Profile rail 35 mm	Profile rail 35 mm
Mechanical data				
Dimensions (WxHxD)	101.6 mm x 76 mm x 48 mm	101.6 mm x 76 mm x 48 mm	101.6 mm x 76 mm x 48 mm	101.6 mm x 76 mm x 48 mm
Weight	219 g	216 g	221 g	220 g
Environmental conditions				
Operating temperature	0 °C to 60 °C	0 °C to 60 °C	0 °C to 60 °C	0 °C to 60 °C
Storage temperature	-25 °C to 70 °C	-25 °C to 70 °C	-25 °C to 70 °C	-25 °C to 70 °C
Certifications				
UL508 certification	yes	yes	yes	yes

Connections, Interfaces

Interface modules | Fieldbus slave modules with I/Os, DIO

153-4CF00	153-6CH00	153-6PL10			
153-4CH00	153-6CL10				
153-4PF00	153-6PH00				
153-4PH00	153-6PL00				

153-4CF00



CAN

- ① n. c.
- ② CAN low
- ③ CAN Ground
- ④ n. c.
- ⑤ n. c.
- ⑥ optional Ground
- ⑦ CAN high
- ⑧ n. c.
- ⑨ n. c.

X1

- ① L+
- ② M
- ③ PE

X3

1 L+

2

3

4

5

6

7

8

9

10 M

X4 X4M

1 1

2 2

3 3

4 4

5 5

6 6

7 7

8 8

9 9

10 10

11 11

DC 24V

153-4CH00

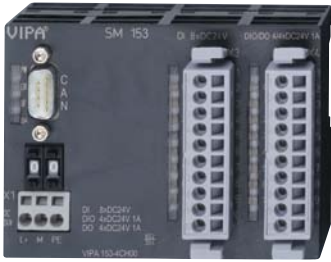

CAN

- ① n. c.
- ② CAN low
- ③ CAN Ground
- ④ n. c.
- ⑤ n. c.
- ⑥ optional Ground
- ⑦ CAN high
- ⑧ n. c.
- ⑨ n. c.

X1

- ① L+
- ② M
- ③ PE

X3

1

2

3

4

5

6

7

8

9

10 M

X4

1 L+

2

3

4

5

6

7

8

9

10 M

DC 24V

DC 24V

153-4PF00



DP RS485

- ① shield
- ② n. c.
- ③ Rx/D/TxD-P (line B)
- ④ RTS
- ⑤ M5V
- ⑥ P5V
- ⑦ n. c.
- ⑧ Rx/D/TxD-N (line A)
- ⑨ n. c.

X1

- ① L+
- ② M
- ③ PE

X3

1 L+

2

3

4

5

6

7

8

9

10 M

X4 X4M

1 1

2 2

3 3

4 4

5 5

6 6

7 7

8 8

9 9

10 10

11 11

DC 24V

153-4PH00

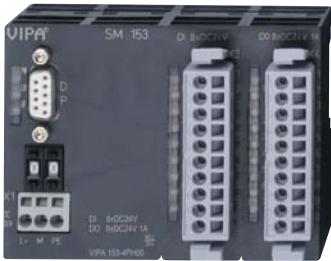

DP RS485

- ① shield
- ② n. c.
- ③ Rx/D/TxD-P (line B)
- ④ RTS
- ⑤ M5V
- ⑥ P5V
- ⑦ n. c.
- ⑧ Rx/D/TxD-N (line A)
- ⑨ n. c.

X1

- ① L+
- ② M
- ③ PE

X3

1

2

3

4

5

6

7

8

9

10 M

X4

1 L+

2

3

4

5

6

7

8

9





10 M

DC 24V

DC 24V

Fieldbus slave modules with I/Os, DIO

Interface modules		Fieldbus slave modules with I/Os, DIO			
153-4CF00	153-6CH00	153-6PL10			
153-4CH00	153-6CL10				
153-4PF00	153-6PH00				
153-4PH00	153-6PL00				

Order number	153-6CH00	153-6CL10	153-6PH00	153-6PL00
Figure				
Type	SM 153, CANopen slave	SM 153, CANopen slave	SM 153, PB-DP slave	SM 153, PB-DP slave
General information				
Note	-	-	-	-
Features	<ul style="list-style-type: none"> ▸ CAN slave ▸ 8 (12) inputs ▸ 4 (8) outputs ▸ 4x11 clamps 	<ul style="list-style-type: none"> ▸ CAN slave ▸ 24 inputs ▸ 8 outputs 	<ul style="list-style-type: none"> ▸ PROFIBUS-DP slave ▸ 8 inputs ▸ 8 outputs ▸ 4x11 clamps 	<ul style="list-style-type: none"> ▸ PROFIBUS-DP slave ▸ 16 inputs ▸ 16 outputs
Technical data power supply				
Power supply (rated value)	DC 24 V	DC 24 V	DC 24 V	DC 24 V
Power supply (permitted range)	DC 20.4...28.8 V	DC 20.4...28.8 V	DC 20.4...28.8 V	DC 20.4...28.8 V
Reverse polarity protection	✓	✓	✓	✓
Current consumption (no-load operation)	-	-	-	-
Current consumption (rated value)	55 mA	55 mA	55 mA	55 mA
Technical data digital inputs				
Number of inputs	8 (12)	24	8	16
Cable length, shielded	1000 m	1000 m	1000 m	1000 m
Cable length, unshielded	600 m	600 m	600 m	600 m
Rated load voltage	DC 24 V	DC 24 V	DC 24 V	DC 24 V
Reverse polarity protection of rated load voltage	-	-	-	-
Current consumption from load voltage L+ (without load)	-	-	-	-
Rated value	DC 24 V	DC 24 V	DC 24 V	DC 24 V
Input voltage for signal "0"	DC 0...5 V	DC 0...5 V	DC 0...5 V	DC 0...5 V
Input voltage for signal "1"	DC 15...28.8 V	DC 15...28.8 V	DC 15...28.8 V	DC 15...28.8 V
Input voltage hysteresis	-	-	-	-
Frequency range	-	-	-	-
Input resistance	-	-	-	-
Input current for signal "1"	7 mA	7 mA	7 mA	7 mA
Connection of Two-Wire-BEROs possible	✓	✓	✓	✓
Max. permissible BERO quiescent current	1.5 mA	1.5 mA	1.5 mA	1.5 mA
Input delay of "0" to "1"	3 ms	3 ms	3 ms	3 ms
Input delay of "1" to "0"	3 ms	3 ms	3 ms	3 ms
Number of simultaneously utilizable inputs horizontal configuration	12	24	8	16
Number of simultaneously utilizable inputs vertical configuration	12	24	8	16
Input characteristic curve	IEC 61131-2, type 1	IEC 61131-2, type 1	IEC 61131-2, type 1	IEC 61131-2, type 1
Initial data size	2 Byte	3 Byte	1 Byte	2 Byte

Interface modules Fieldbus slave modules with I/Os, DIO					
153-4CF00	153-6CH00	153-6PL10			
153-4CH00	153-6CL10				
153-4PF00	153-6PH00				
153-4PH00	153-6PL00				

Order number	153-6CH00	153-6CL10	153-6PH00	153-6PL00
Technical data digital outputs				
Number of outputs	8 (4)	8	8	16
Cable length, shielded	1000 m	1000 m	1000 m	1000 m
Cable length, unshielded	600 m	600 m	600 m	600 m
Rated load voltage	DC 24 V	DC 24 V	DC 24 V	DC 24 V
Reverse polarity protection of rated load voltage	-	-	-	-
Current consumption from load voltage L+ (without load)	55 mA	55 mA	55 mA	55 mA
Total current per group, horizontal configuration, 40°C	4 A	4 A	4 A	4 A
Total current per group, horizontal configuration, 60°C	2 A	2 A	2 A	2 A
Total current per group, vertical configuration	2 A	2 A	2 A	2 A
Output voltage signal "1" at min. current	L+ (-0.8 V)	L+ (-0.8 V)	L+ (-0.8 V)	L+ (-0.8 V)
Output voltage signal "1" at max. current	L+ (-1.5 V)	L+ (-1.5 V)	L+ (-1.5 V)	L+ (-1.5 V)
Output current at signal "1", rated value	1 A	1 A	1 A	1 A
Output delay of "0" to "1"	150 µs	150 µs	150 µs	150 µs
Output delay of "1" to "0"	100 µs	100 µs	100 µs	100 µs
Minimum load current	-	-	-	-
Lamp load	5 W	5 W	5 W	5 W
Parallel switching of outputs for redundant control of a load	not possible	not possible	not possible	not possible
Parallel switching of outputs for increased power	not possible	not possible	not possible	not possible
Actuation of digital input	✓	✓	✓	✓
Switching frequency with resistive load	max. 1000 Hz	max. 1000 Hz	max. 1000 Hz	max. 1000 Hz
Switching frequency with inductive load	max. 0.5 Hz	max. 0.5 Hz	max. 0.5 Hz	max. 0.5 Hz
Switching frequency on lamp load	max. 10 Hz	max. 10 Hz	max. 10 Hz	max. 10 Hz
Internal limitation of inductive shut-off voltage	L+ (-52 V)	L+ (-52 V)	L+ (-52 V)	L+ (-52 V)
Short-circuit protection of output	yes, electronic	yes, electronic	yes, electronic	yes, electronic
Trigger level	1.5 A	1.5 A	1.5 A	1.5 A
Number of operating cycle of relay outputs	-	-	-	-
Switching capacity of contacts	-	-	-	-
Output data size	1 Byte	1 Byte	1 Byte	2 Byte
Status information, alarms, diagnostics				
Status display	green LED per channel	green LED per channel	green LED per channel	green LED per channel
Interrupts	no	no	no	no
Process alarm	no	no	no	no
Diagnostic interrupt	no	no	no	no
Diagnostic functions	no	no	no	no
Diagnostics information read-out	possible	possible	possible	possible
Supply voltage display	yes	yes	yes	yes
Group error display	red SF LED	red SF LED	red SF LED	red SF LED
Channel error display	none	none	none	none

Interface modules Fieldbus slave modules with I/Os, DIO					
153-4CF00	153-6CH00	153-6PL10			
153-4CH00	153-6CL10				
153-4PF00	153-6PH00				
153-4PH00	153-6PL00				

Order number	153-6CH00	153-6CL10	153-6PH00	153-6PL00
Isolation				
Between channels	-	-	-	-
Between channels of groups to	-	-	-	-
Between channels and backplane bus	-	-	-	-
Between channels and power supply	-	-	-	-
Max. potential difference between circuits	-	-	-	-
Max. potential difference between inputs (Ucm)	-	-	-	-
Max. potential difference between Mana and Mintern (Uiso)	-	-	-	-
Max. potential difference between inputs and Mana (Ucm)	-	-	-	-
Max. potential difference between inputs and Mintern (Uiso)	-	-	-	-
Max. potential difference between Mintern and outputs	-	-	-	-
Insulation tested with	DC 500 V	DC 500 V	DC 500 V	DC 500 V
Hardware configuration				
Racks, max.	-	-	-	-
Modules per rack, max.	-	-	-	-
Number of digital modules, max.	-	-	-	-
Number of analog modules, max.	-	-	-	-
Communication				
Fieldbus	CANopen	CANopen	PROFIBUS-DP to EN 50170	PROFIBUS-DP to EN 50170
Type of interface	CAN	CAN	RS485	RS485
Connector	Sub-D, 9-pin, male	Sub-D, 9-pin, male	Sub-D, 9-pin, female	Sub-D, 9-pin, female
Topology	Linear bus with bus termination at both ends	Linear bus with bus termination at both ends	Linear bus with bus termination at both ends	Linear bus with bus termination at both ends
Electrically isolated	✓	✓	✓	✓
Number of participants, max.	126	126	125	125
Node addresses	1 - 99	1 - 99	1 - 99	1 - 99
Transmission speed, min.	10 kbit/s	10 kbit/s	9.6 kbit/s	9.6 kbit/s
Transmission speed, max.	1 Mbit/s	1 Mbit/s	12 Mbit/s	12 Mbit/s
Address range inputs, max.	2 Byte	3 Byte	1 Byte	2 Byte
Address range outputs, max.	1 Byte	1 Byte	1 Byte	2 Byte
Number of TxPDOs, max.	1	1	-	-
Number of RxPDOs, max.	1	1	-	-
Datasizes				
Input bytes	2	3	1	2
Output bytes	1	1	1	2
Parameter bytes	-	-	7 + 5	7 + 5
Diagnostic bytes	-	-	13	13

Interface modules Fieldbus slave modules with I/Os, DIO						
153-4CF00	153-6CH00	153-6PL10				
153-4CH00	153-6CL10					
153-4PF00	153-6PH00					
153-4PH00	153-6PL00					

Order number	153-6CH00	153-6CL10	153-6PH00	153-6PL00
Housing				
Material	PPE / PA 6.6	PPE / PA 6.6	PPE / PA 6.6	PPE / PA 6.6
Mounting	Profile rail 35 mm	Profile rail 35 mm	Profile rail 35 mm	Profile rail 35 mm
Mechanical data				
Dimensions (WxHxD)	152.4 mm x 76 mm x 48 mm	152.4 mm x 76 mm x 48 mm	152.4 mm x 76 mm x 48 mm	152.4 mm x 76 mm x 48 mm
Weight	266 g	311 g	268 g	264 g
Environmental conditions				
Operating temperature	0 °C to 60 °C	0 °C to 60 °C	0 °C to 60 °C	0 °C to 60 °C
Storage temperature	-25 °C to 70 °C	-25 °C to 70 °C	-25 °C to 70 °C	-25 °C to 70 °C
Certifications				
UL508 certification	yes	yes	yes	yes

Connections, Interfaces

Interface modules | Fieldbus slave modules with I/Os, DIO

153-4CF00 153-4CH00 153-4PF00 153-4PH00	153-6CH00 153-6CL10 153-6PH00 153-6PL00	153-6PL10			
--	--	-----------	--	--	--

153-6CH00



CAN

- ① n. c.
- ② CAN low
- ③ CAN Ground
- ④ n. c.
- ⑤ n. c.
- ⑥ optional Ground
- ⑦ CAN high
- ⑧ n. c.
- ⑨ n. c.

X1

- ① L+
- ② M
- ③ PE

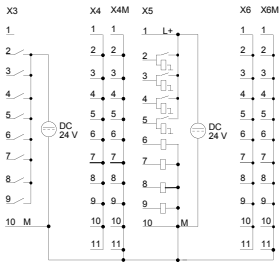

153-6CL10

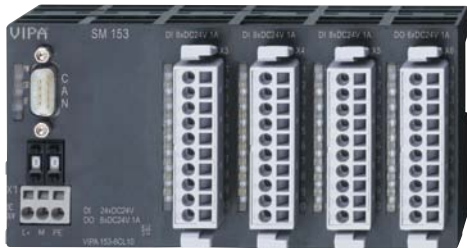

CAN

- ① n. c.
- ② CAN low
- ③ CAN Ground
- ④ n. c.
- ⑤ n. c.
- ⑥ optional Ground
- ⑦ CAN high
- ⑧ n. c.
- ⑨ n. c.

X1

- ① L+
- ② M
- ③ PE

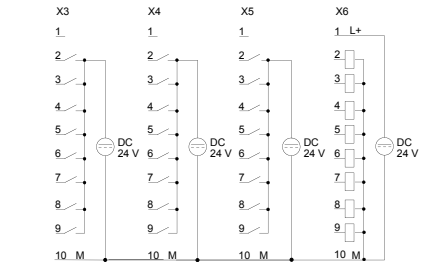

153-6PH00



DP RS485

- ① shield
- ② n. c.
- ③ RxD/TxD-P (line B)
- ④ RTS
- ⑤ MSV
- ⑥ PSV
- ⑦ n. c.
- ⑧ RxD/TxD-N (line A)
- ⑨ n. c.

X1

- ① L+
- ② M
- ③ PE

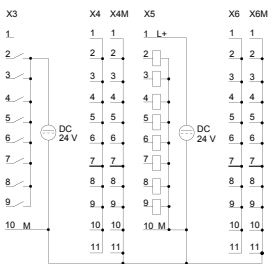

153-6PL00



DP RS485

- ① shield
- ② n. c.
- ③ RxD/TxD-P (line B)
- ④ RTS
- ⑤ MSV
- ⑥ PSV
- ⑦ n. c.
- ⑧ RxD/TxD-N (line A)
- ⑨ n. c.

X1

- ① L+
- ② M
- ③ PE

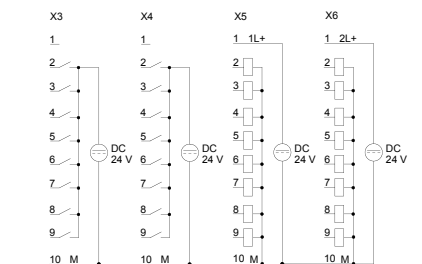

Fieldbus slave modules with I/Os, DIO

Interface modules Fieldbus slave modules with I/Os, DIO					
153-4CF00	153-6CH00	153-6PL10			
153-4CH00	153-6CL10				
153-4PF00	153-6PH00				
153-4PH00	153-6PL00				

Order number	153-6PL10			
Figure				
Type	SM 153, PB-DP slave			
General information				
Note	-			
Features	<ul style="list-style-type: none"> ▶ PROFIBUS-DP slave ▶ 24 inputs ▶ 8 outputs 			
Technical data power supply				
Power supply (rated value)	DC 24 V			
Power supply (permitted range)	DC 20.4...28.8 V			
Reverse polarity protection	✓			
Current consumption (no-load operation)	-			
Current consumption (rated value)	55 mA			
Technical data digital inputs				
Number of inputs	24			
Cable length, shielded	1000 m			
Cable length, unshielded	600 m			
Rated load voltage	DC 24 V			
Reverse polarity protection of rated load voltage	-			
Current consumption from load voltage L+ (without load)	-			
Rated value	DC 24 V			
Input voltage for signal "0"	DC 0...5 V			
Input voltage for signal "1"	DC 15...28.8 V			
Input voltage hysteresis	-			
Frequency range	-			
Input resistance	-			
Input current for signal "1"	7 mA			
Connection of Two-Wire-BEROs possible	✓			
Max. permissible BERO quiescent current	1.5 mA			
Input delay of "0" to "1"	3 ms			
Input delay of "1" to "0"	3 ms			
Number of simultaneously utilizable inputs horizontal configuration	24			
Number of simultaneously utilizable inputs vertical configuration	24			
Input characteristic curve	IEC 61131-2, type 1			
Initial data size	3 Byte			

Interface modules Fieldbus slave modules with I/Os, DIO						
153-4CF00	153-6CH00	153-6PL10				
153-4CH00	153-6CL10					
153-4PF00	153-6PH00					
153-4PH00	153-6PL00					

Order number	153-6PL10			
Technical data digital outputs				
Number of outputs	8			
Cable length, shielded	1000 m			
Cable length, unshielded	600 m			
Rated load voltage	DC 24 V			
Reverse polarity protection of rated load voltage	-			
Current consumption from load voltage L+ (without load)	50 mA			
Total current per group, horizontal configuration, 40°C	4 A			
Total current per group, horizontal configuration, 60°C	2 A			
Total current per group, vertical configuration	2 A			
Output voltage signal "1" at min. current	L+ (-0.8 V)			
Output voltage signal "1" at max. current	L+ (-1.5 V)			
Output current at signal "1", rated value	1 A			
Output delay of "0" to "1"	150 µs			
Output delay of "1" to "0"	100 µs			
Minimum load current	-			
Lamp load	5 W			
Parallel switching of outputs for redundant control of a load	not possible			
Parallel switching of outputs for increased power	not possible			
Actuation of digital input	✓			
Switching frequency with resistive load	max. 1000 Hz			
Switching frequency with inductive load	max. 0.5 Hz			
Switching frequency on lamp load	max. 10 Hz			
Internal limitation of inductive shut-off voltage	L+ (-52 V)			
Short-circuit protection of output	yes, electronic			
Trigger level	1.5 A			
Number of operating cycle of relay outputs	-			
Switching capacity of contacts	-			
Output data size	1 Byte			
Status information, alarms, diagnostics				
Status display	green LED per channel			
Interrupts	no			
Process alarm	no			
Diagnostic interrupt	no			
Diagnostic functions	no			
Diagnostics information read-out	possible			
Supply voltage display	yes			
Group error display	red SF LED			
Channel error display	none			

Interface modules Fieldbus slave modules with I/Os, DIO						
153-4CF00	153-6CH00	153-6PL10				
153-4CH00	153-6CL10					
153-4PF00	153-6PH00					
153-4PH00	153-6PL00					

Order number	153-6PL10			
Isolation				
Between channels	-			
Between channels of groups to	-			
Between channels and backplane bus	-			
Between channels and power supply	-			
Max. potential difference between circuits	-			
Max. potential difference between inputs (Ucm)	-			
Max. potential difference between Mana and Mintern (Uiso)	-			
Max. potential difference between inputs and Mana (Ucm)	-			
Max. potential difference between inputs and Mintern (Uiso)	-			
Max. potential difference between Mintern and outputs	-			
Insulation tested with	DC 500 V			
Hardware configuration				
Racks, max.	-			
Modules per rack, max.	-			
Number of digital modules, max.	-			
Number of analog modules, max.	-			
Communication				
Fieldbus	PROFIBUS-DP to EN 50170			
Type of interface	RS485			
Connector	Sub-D, 9-pin, female			
Topology	Linear bus with bus termination at both ends			
Electrically isolated	✓			
Number of participants, max.	125			
Node addresses	1 - 99			
Transmission speed, min.	9.6 kbit/s			
Transmission speed, max.	12 Mbit/s			
Address range inputs, max.	3 Byte			
Address range outputs, max.	1 Byte			
Number of TxPDOs, max.	-			
Number of RxPDOs, max.	-			
Datasizes				
Input bytes	3			
Output bytes	1			
Parameter bytes	7 + 5			
Diagnostic bytes	13			

Interface modules		Fieldbus slave modules with I/Os, DIO				
153-4CF00	153-6CH00	153-6PL10				
153-4CH00	153-6CL10					
153-4PF00	153-6PH00					
153-4PH00	153-6PL00					

Order number	153-6PL10			
Housing				
Material	PPE / PA 6.6			
Mounting	Profile rail 35 mm			
Mechanical data				
Dimensions (WxHxD)	152.4 mm x 76 mm x 48 mm			
Weight	264 g			
Environmental conditions				
Operating temperature	0 °C to 60 °C			
Storage temperature	-25 °C to 70 °C			
Certifications				
UL508 certification	yes			

Connections, Interfaces

Interface modules | Fieldbus slave modules with I/Os, DIO

153-4CF00	153-6CH00	153-6PL10				
153-4CH00	153-6CL10					
153-4PF00	153-6PH00					
153-4PH00	153-6PL00					

153-6PL10



DP RS485

- ① shield
- ② n.c.
- ③ RxD/TxD-P (line B)
- ④ RTS
- ⑤ MSV
- ⑥ PSV
- ⑦ n.c.
- ⑧ RxD/TxD-N (line A)
- ⑨ n.c.

X1

- ① L+
- ② M
- ③ PE

X3 X4 X5 X6

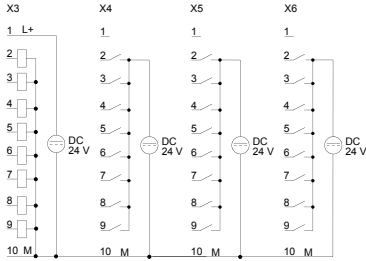

100V accessories



Structure and Function

System accessories expand the use of the system and facilitate starting.

Note: Bus connector, front connector and label strips are supplied with the modules.

Memory Expansion

MMC cards can be used to store program and data.

Bus Connectors

By using backplane bus connectors, communication between the modules is realized.

35 mm Profile Rail

With the help of 35 mm profile rails, the respective modules can be mounted directly on the mounting surface. The profile rail can be ordered in various lengths.

Front Connectors

The front connectors are included and supplied with the CPU and signal modules, but may also be ordered separately as spare parts.

Manuals

The technical documentation of the respective assemblies comprises various manuals with the necessary hardware and programming information, detailed descriptions of each module, and instructions for structure and assembly.



Bus connectors



Order number	Type	Description	Note
290-0AA10	Bus connector	1-tier	

35 mm profile rail



Order number	Type	Description	Note
290-1AF00	35 mm profile rail	length 2000 mm	
290-1AF30	35 mm profile rail	length 530 mm	

Front connector



Order number	Type	Description	Note
292-1AF00	Front connector	10 pin with cage clamps (included in the scope of delivery of signal modules)	

MMC memory



Order number	Type	Description	Note
953-0KX10	MMC - MultiMediaCard	Extension memory for VIPA CPUs 11x, 21x, 24x, 31x, 51x, and 208-1DP01, CC 03 (for load memory not necessary)	

Manuals and operating instructions



Order number	Title	Contents	Language
HB100D	Manual System 100V - Compendium, German	HB100D_CM, HB100D_EM, HB100D_SM-PB, HB100D_SM-CAN	DE
HB100E	Manual System 100V - Compendium, English	HB100E_CM, HB100E_EM, HB100E_SM-PB, HB100E_SM-CAN	EN
HB100D_CM	Manual System 100V - German	CM - Clamps modules	DE
HB100E_CM	Manual System 100V - English	CM - Clamps modules	EN
HB100D_CPU	Manual System 100V - German	CPU 11x, incl. operations list	DE
HB100E_CPU	Manual System 100V - English	CPU 11x, incl. operations list	EN
HB100D_EM	Manual System 100V - German	EM - Expansion modules	DE
HB100E_EM	Manual System 100V - English	EM - Expansion modules	EN
HB100D_SM-CAN	Manual System 100V - German	SM-CAN - Block I/O CAN	DE
HB100E_SM-CAN	Manual System 100V - English	SM-CAN - Block I/O CAN	EN
HB100D_SM-PB	Manual System 100V - German	SM-PB - Block I/O PROFIBUS	DE
HB100E_SM-PB	Manual System 100V - English	SM-PB - Block I/O PROFIBUS	EN

At a glance

System description 200V	244
CPUs	246
Clamp modules	294
Power supply	298
Signal modules digital	304
Signal modules analog	344
Communication processors	370
Function modules	382
Interface modules	394
200V accessories	406



| 200V

System description 200V

Structure and Concept

200V is a highly compact and modular expandable system.

The system is designed for centralized and decentralized automation tasks.

With a central extension of a maximum of 32 modules directly to the CPU and up to 126 fieldbus slave modules with a further maximum of 32 modules per fieldbus slave module, 200V is highly flexible. The module size allows use in almost any automation environment.

The assembly is extremely simple. The bus connector for communication between the modules and the CPU can be easily inserted into a 35 mm standard rail, and then 200V modules are snapped on – finished.

Included with the supply of the signal and function modules are front connectors and labeling strips.



Performance and Application

200V is designed for centralized and decentralized automation tasks in the manufacturing and process industry up to medium power range.

Programming

200V is programmed with VIPA WinPLC7 or with Siemens STEP7 in LAD, FBD and STL.

Memory

The CPUs in 200V have the work and load memory already integrated. Depending on the CPU version, users can choose from 48 kByte to 128 kByte work memory. In addition, MMC cards for storing program and data are supported.

Functions

For the connection of sensors and actuators, a variety of signaling modules are available for acquiring digital and analog signals in and out of the process.

For positioning tasks and path measurement various SSI, servo and stepper modules can be chosen.

The counter modules in 200V also support complex and fast counting tasks in the manufacturing and process industry to calculate the comparative features and the connection of sensors, such as photoelectric barriers.

Communication

For the connection of serial devices, e.g. scanner or printer, and for the integration of systems from other manufacturers, the system offers a full complement of serial communication processors.

Ethernet communication processors incorporates 200V horizontally and vertically into the existing network structures, and thus make all relevant data connected to the MES and ERP systems available.

200V possesses fieldbus master and slave modules with various fieldbus protocols and can therefore function, manufacturer-independent, as master control as well as subordinate fieldbus slave unit.

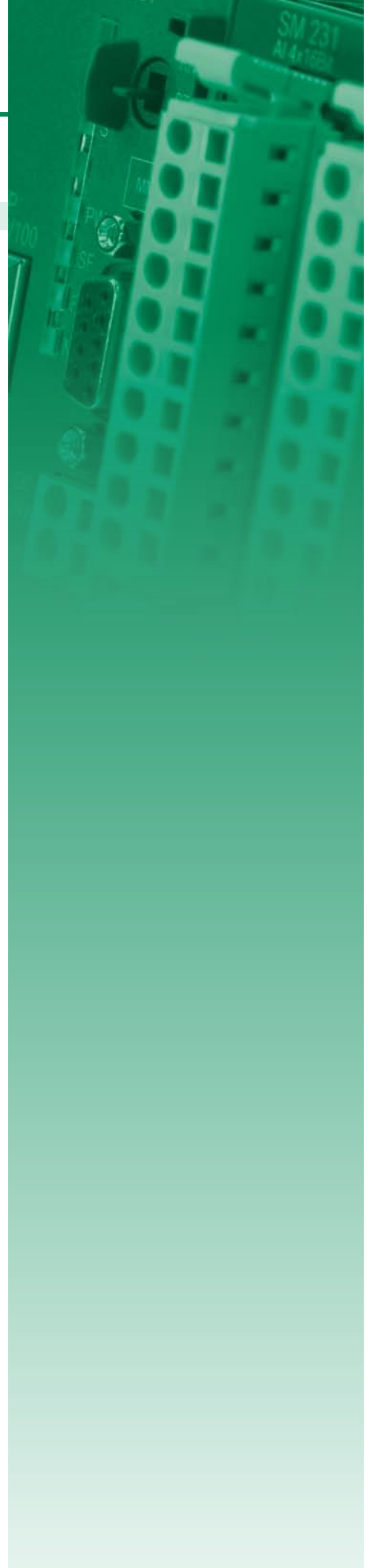

- SLIO
- 100V
- 200V
- 300S
- 500S
- HMI
- Teleservice
- StarterKits
- Safety
- Solutions
- Software
- Accessories
- Appendix

CPUs



CPUs-Central Modules

Central Processing Units (CPU) control and regulate processes in plant and machinery. The CPUs are selected according to application with the appropriate performance and work memory and can be extended with signal and function modules, as well as communication processors.

The system 200V CPUs are designed for small and medium-sized applications and represent as universal automation systems an ideal solution for applications in centralized and decentralized structures.

For the construction of the control a wide CPU-range in various performance classes are available. The various CPUs differ in work memory, address range, number of connections and processing time.

The CPUs of the system 200V are particularly suitable for industrial use and for general control and automation tasks in the medium performance range.

Characteristics

- › Programmable with VIPA WinPLC7 or Siemens STEP7
- › Integrated work memory, operation without additional memory card possible
- › Integrated flash ROM memory for continuous saving of program and data
- › Integrated accumulator-backed RAM memory
- › Support of standard MMC cards for saving of program and data
- › Suitable for centralized and decentralized applications
- › Modular expandable, up to 32 modules can be used
- › Integrated real time clock as well as MPI interface on board
- › Front integrated status LEDs
- › Assembly with 35 mm profile rail
- › 24 months warranty

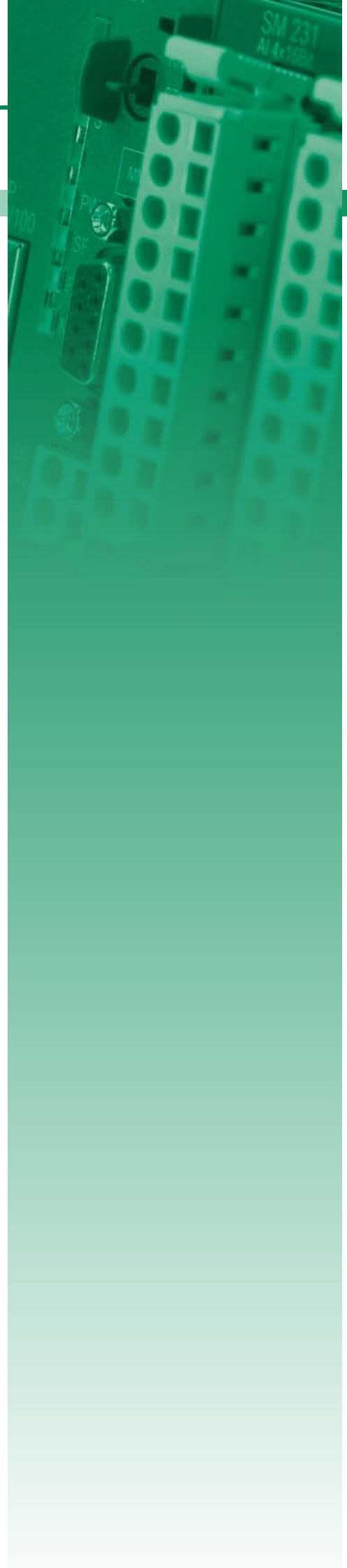

Overview

Order no.	Name/Description	Page
CPUs STEP7 programmable, standard		
214-1BA03	CPU 214 - PLC CPU ‣ 96 kB work memory ‣ 144 kB load memory	249
214-1BA06	CPU 214 - PLC CPU ‣ 96 kB work memory ‣ 144 kB load memory ‣ Also configurable via TIA-Portal	249
214-1BC03	CPU 214C - PLC CPU ‣ 48 kB work memory ‣ 80 kB load memory	249
214-1BC06	CPU 214C - PLC CPU ‣ 48 kB work memory ‣ 80 kB load memory ‣ Also configurable via TIA-Portal	249
215-1BA03	CPU 215 - PLC CPU ‣ 128 kB work memory ‣ 192 kB load memory	254
215-1BA06	CPU 215 - PLC CPU ‣ 128 kB work memory ‣ 192 kB load memory ‣ Also configurable via TIA-Portal	254
CPUs STEP7 programmable, NET-CPUs		
214-2BE03	CPU 214PG - PLC CPU ‣ Twisted pair Ethernet via RJ45 ‣ 96 kB work memory ‣ 144 kB load memory	259
214-2BT13	CPU 214NET - PLC CPU ‣ Ethernet CP 243 ‣ Twisted pair Ethernet via RJ45 ‣ 96 kB work memory ‣ 144 kB load memory	259
215-2BE03	CPU 215PG - PLC CPU ‣ Twisted pair Ethernet via RJ45 ‣ 128 kB work memory ‣ 192 kB load memory	259
215-2BT13	CPU 215NET - PLC CPU ‣ Ethernet CP 243 ‣ Twisted pair Ethernet via RJ45 ‣ 128 kB work memory ‣ 192 kB load memory	259
CPUs STEP7 programmable, PtP		
214-2BS03	CPU 214SER - PLC CPU ‣ Serial communication via 2x RS232 ‣ 96 kB work memory ‣ 144 kB load memory	265
214-2BS13	CPU 214SER - PLC CPU ‣ Serial communication via RS232 ‣ 96 kB work memory ‣ 144 kB load memory	265
214-2BS33	CPU 214SER - PLC CPU ‣ Serial communication via RS485 ‣ 96 kB work memory ‣ 144 kB load memory	265
215-2BS03	CPU 215SER - PLC CPU ‣ Serial communication via 2x RS232 ‣ 128 kB work memory ‣ 192 kB load memory	265
215-2BS13	CPU 215SER - PLC CPU ‣ Serial communication via RS232 ‣ 128 kB work memory ‣ 192 kB load memory	271
215-2BS33	CPU 215SER - PLC CPU ‣ Serial communication via RS485 ‣ 128 kB work memory ‣ 192 kB load memory	271



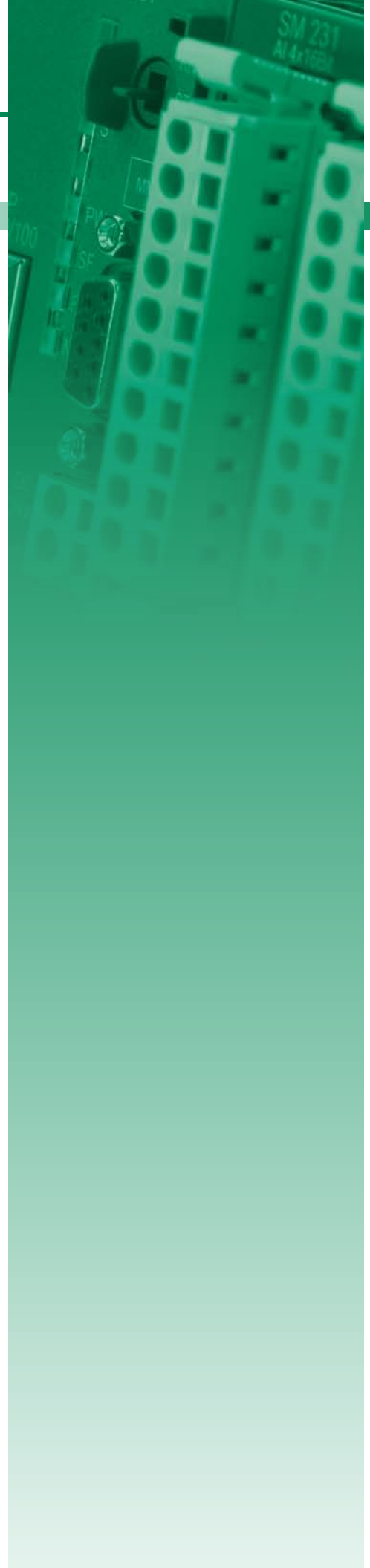

Overview

Order no.	Name/Description	Page
CPUs STEP7 programmable, DP master		
214-2BM03	CPU 214DPM - PLC CPU ▶ PROFIBUS-DP master ▶ 96 kB work memory ▶ 144 kB load memory	277
214-2BM06	CPU 214DPM - PLC CPU ▶ PROFIBUS-DP master ▶ 96 kB work memory ▶ 144 kB load memory ▶ Also configurable via TIA-Portal	277
215-2BM03	CPU 215DPM - PLC CPU ▶ PROFIBUS-DP master ▶ 128 kB work memory ▶ 192 kB load memory	277
CPUs STEP7 programmable, DP slave		
214-2BP03	CPU 214DP - PLC CPU ▶ PROFIBUS-DP slave ▶ 96 kB work memory ▶ 144 kB load memory	283
215-2BP03	CPU 215DP - PLC CPU ▶ PROFIBUS-DP slave ▶ 128 kB work memory ▶ 192 kB load memory	283
CPUs STEP7 programmable, CAN master		
214-2CM03	CPU 214CAN - PLC CPU ▶ CANopen master ▶ 96 kB work memory ▶ 144 kB load memory	288
215-2CM03	CPU 215CAN - PLC CPU ▶ CANopen master ▶ 128 kB work memory ▶ 192 kB load memory	288



CPU STEP7 programmable, standard

CPUs CPU STEP7 programmable, standard						
214-1BA03	215-1BA03					
214-1BA06	215-1BA06					
214-1BC03						
214-1BC06						

Order number	214-1BA03	214-1BA06	214-1BC03	214-1BC06
Figure				
Type	CPU 214	CPU 214	CPU 214C	CPU 214C
General information				
Note	-	-	-	-
Features	<ul style="list-style-type: none"> ▸ 96 kB work memory ▸ 144 kB load memory 	<ul style="list-style-type: none"> ▸ 96 kB work memory ▸ 144 kB load memory ▸ Also configurable via TIA-Portal 	<ul style="list-style-type: none"> ▸ 48 kB work memory ▸ 80 kB load memory 	<ul style="list-style-type: none"> ▸ 48 kB work memory ▸ 80 kB load memory ▸ Also configurable via TIA-Portal
Technical data power supply				
Power supply (rated value)	DC 24 V	DC 24 V	DC 24 V	DC 24 V
Power supply (permitted range)	DC 20.4...28.8 V	DC 20.4...28.8 V	DC 20.4...28.8 V	DC 20.4...28.8 V
Reverse polarity protection	✓	✓	✓	✓
Current consumption (no-load operation)	50 mA	50 mA	50 mA	50 mA
Current consumption (rated value)	1.5 A	1.5 A	1.5 A	1.5 A
Inrush current	65 A	65 A	65 A	65 A
I ² t	0.75 A ² s	0.75 A ² s	0.75 A ² s	0.75 A ² s
Max. current drain at backplane bus	3 A	3 A	3 A	3 A
Power loss	3.5 W	3.5 W	3.5 W	3.5 W
Load and working memory				
Load memory, integrated	144 KB	144 KB	80 KB	80 KB
Load memory, maximum	144 KB	144 KB	80 KB	80 KB
Work memory, integrated	96 KB	96 KB	48 KB	48 KB
Work memory, maximal	96 KB	96 KB	48 KB	48 KB
Memory divided in 50% program / 50% data	-	-	-	-
Memory card slot	MMC-Card with max. 512 MB	MMC-Card with max. 512 MB	MMC-Card with max. 512 MB	MMC-Card with max. 512 MB
Hardware configuration				
Racks, max.	4	4	4	4
Modules per rack, max.	total max. 32	total max. 32	total max. 32	total max. 32
Number of integrated DP master	-	-	-	-
Number of DP master via CP	8	8	8	8
Operable function modules	32	32	32	32
Operable communication modules PtP	32	32	32	32
Operable communication modules LAN	-	-	-	-
Command processing times				
Bit instructions, min.	0.18 µs	0.18 µs	0.18 µs	0.18 µs
Word instruction, min.	0.78 µs	0.78 µs	0.78 µs	0.78 µs
Double integer arithmetic, min.	1.8 µs	1.8 µs	1.8 µs	1.8 µs
Floating-point arithmetic, min.	40 µs	40 µs	40 µs	40 µs

SLIO
100V
200V
300S
500S
HMI
Teleservice
StarterKits
Safety
Solutins
Software
Accessories
Appendix

CPUs CPUs STEP7 programmable, standard					
214-1BA03	215-1BA03				
214-1BA06	215-1BA06				
214-1BC03					
214-1BC06					

Order number	214-1BA03	214-1BA06	214-1BC03	214-1BC06
Timers/Counters and their retentive characteristics				
Number of S7 counters	256	256	256	256
S7 counter remanence	adjustable 0 up to 64	adjustable 0 up to 64	adjustable 0 up to 64	adjustable 0 up to 64
S7 counter remanence adjustable	C0 .. C7	C0 .. C7	C0 .. C7	C0 .. C7
Number of S7 times	256	256	256	256
S7 times remanence	adjustable 0 up to 128	adjustable 0 up to 128	adjustable 0 up to 128	adjustable 0 up to 128
S7 times remanence adjustable	not retentive	not retentive	not retentive	not retentive
Data range and retentive characteristic				
Number of flags	8192 Bit	8192 Bit	8192 Bit	8192 Bit
Bit memories retentive characteristic adjustable	adjustable 0 up to 256	adjustable 0 up to 256	adjustable 0 up to 256	adjustable 0 up to 256
Bit memories retentive characteristic preset	MB0 .. MB15	MB0 .. MB15	MB0 .. MB15	MB0 .. MB15
Number of data blocks	2047	2047	2047	2047
Max. data blocks size	16 KB	16 KB	16 KB	16 KB
Number range DBs	1 ... 2047	1 ... 2047	1 ... 2047	1 ... 2047
Max. local data size per execution level	1024 Byte	1024 Byte	1024 Byte	1024 Byte
Max. local data size per block	1024 Byte	1024 Byte	1024 Byte	1024 Byte
Blocks				
Number of OBs	14	14	14	14
Maximum OB size	16 KB	16 KB	16 KB	16 KB
Totalnumber DBs, FBs, FCs	-	-	-	-
Number of FBs	1024	1024	1024	1024
Maximum FB size	16 KB	16 KB	16 KB	16 KB
Number range FBs	0 ... 1023	0 ... 1023	0 ... 1023	0 ... 1023
Number of FCs	1024	1024	1024	1024
Maximum FC size	16 KB	16 KB	16 KB	16 KB
Number range FC2	0 ... 1023	0 ... 1023	0 ... 1023	0 ... 1023
Maximum nesting depth per priority class	8	8	8	8
Maximum nesting depth additional within an error OB	1	1	1	1
Time				
Real-time clock buffered	✓	✓	✓	✓
Clock buffered period (min.)	30 d	30 d	30 d	30 d
Type of buffering	-	-	-	-
Load time for 50% buffering period	20 h	20 h	20 h	20 h
Load time for 100% buffering period	48 h	48 h	48 h	48 h
Accuracy (max. deviation per day)	10 s	10 s	10 s	10 s
Number of operating hours counter	8	8	8	8
Clock synchronization	-	-	-	-
Synchronization via MPI	-	-	-	-
Synchronization via Ethernet (NTP)	-	-	-	-

SLIO
100V
200V
300S
500S
HMI
Teleservice
StarterKits
Safety
Solutions
Software
Accessories
Appendix

CPU CPU STEP7 programmable, standard					
214-1BA03	215-1BA03				
214-1BA06	215-1BA06				
214-1BC03					
214-1BC06					

Order number	214-1BA03	214-1BA06	214-1BC03	214-1BC06
Address areas (I/O)				
Input I/O address area	1024 Byte	1024 Byte	1024 Byte	1024 Byte
Output I/O address area	1024 Byte	1024 Byte	1024 Byte	1024 Byte
Process image adjustable	-	-	-	-
Input process image preset	128 Byte	128 Byte	128 Byte	128 Byte
Output process image preset	128 Byte	128 Byte	128 Byte	128 Byte
Input process image maximal	128 Byte	128 Byte	128 Byte	128 Byte
Output process image maximal	128 Byte	128 Byte	128 Byte	128 Byte
Digital inputs	8192	8192	8192	8192
Digital outputs	8192	8192	8192	8192
Digital inputs central	512	512	512	512
Digital outputs central	512	512	512	512
Integrated digital inputs	-	-	-	-
Integrated digital outputs	-	-	-	-
Analog inputs	512	512	512	512
Analog outputs	512	512	512	512
Analog inputs, central	128	128	128	128
Analog outputs, central	128	128	128	128
Integrated analog inputs	-	-	-	-
Integrated analog outputs	-	-	-	-
Communication functions				
PG/OP channel	✓	✓	✓	✓
Global data communication	✓	✓	✓	✓
Number of GD circuits, max.	4	4	4	4
Size of GD packets, max.	22 Byte	22 Byte	22 Byte	22 Byte
S7 basic communication	✓	✓	✓	✓
S7 basic communication, user data per job	76 Byte	76 Byte	76 Byte	76 Byte
S7 communication	✓	✓	✓	✓
S7 communication as server	✓	✓	✓	✓
S7 communication as client	-	-	-	-
S7 communication, user data per job	160 Byte	160 Byte	160 Byte	160 Byte
Number of connections, max.	16	16	16	16
Functionality Sub-D interfaces				
Type	MP ² I	MP ² I	MP ² I	MP ² I
Type of interface	RS485	RS485	RS485	RS485
Connector	Sub-D, 9-pin, female	Sub-D, 9-pin, female	Sub-D, 9-pin, female	Sub-D, 9-pin, female
Electrically isolated	-	-	-	-
MPI	✓	✓	✓	✓
MP ² I (MPI/RS232)	✓	✓	✓	✓
Point-to-point interface	-	-	-	-

SLIO
100V
200V
300S
500S
HMI
Teleservice
StarterKits
Safety
Solutions
Software
Accessories
Appendix

CPUs CPUs STEP7 programmable, standard					
214-1BA03	215-1BA03				
214-1BA06	215-1BA06				
214-1BC03					
214-1BC06					

Order number	214-1BA03	214-1BA06	214-1BC03	214-1BC06
Functionality MPI				
Number of connections, max.	16	16	16	16
PG/OP channel	✓	✓	✓	✓
Routing	-	-	-	-
Global data communication	✓	✓	✓	✓
S7 basic communication	✓	✓	✓	✓
S7 communication	✓	✓	✓	✓
S7 communication as server	✓	✓	✓	✓
S7 communication as client	-	-	-	-
Transmission speed, min.	19.2 kbit/s	19.2 kbit/s	19.2 kbit/s	19.2 kbit/s
Transmission speed, max.	187.5 kbit/s	187.5 kbit/s	187.5 kbit/s	187.5 kbit/s
Datasizes				
Input bytes	0	0	0	0
Output bytes	0	0	0	0
Parameter bytes	3	3	3	3
Diagnostic bytes	0	0	0	0
Housing				
Material	PPE / PA 6.6	PPE / PA 6.6	PPE / PA 6.6	PPE / PA 6.6
Mounting	Profile rail 35 mm	Profile rail 35 mm	Profile rail 35 mm	Profile rail 35 mm
Mechanical data				
Dimensions (WxHxD)	25.4 mm x 76 mm x 80 mm	25.4 mm x 76 mm x 80 mm	25.4 mm x 76 mm x 80 mm	25.4 mm x 76 mm x 80 mm
Weight	100 g	100 g	100 g	100 g
Environmental conditions				
Operating temperature	0 °C to 60 °C	0 °C to 60 °C	0 °C to 60 °C	0 °C to 60 °C
Storage temperature	-25 °C to 70 °C	-25 °C to 70 °C	-25 °C to 70 °C	-25 °C to 70 °C
Certifications				
UL508 certification	yes	in preparation	yes	in preparation

Connections, Interfaces

CPUs | CPUs STEP7 programmable, standard

214-1BA03 214-1BA06 214-1BC03 214-1BC06	215-1BA03 215-1BA06					
--	------------------------	--	--	--	--	--

214-1BA03



MP²

- ① reserved
- ② M24V
- ③ RxD/TxD-P (line B)
- ④ RTS
- ⑤ M5V
- ⑥ P5V
- ⑦ P24V
- ⑧ RxD/TxD-N (line A)
- ⑨ n.c.

X1

- + ① + DC 24 V
- ② 0 V

214-1BA06



MP²

- ① reserved
- ② M24V
- ③ RxD/TxD-P (line B)
- ④ RTS
- ⑤ M5V
- ⑥ P5V
- ⑦ P24V
- ⑧ RxD/TxD-N (line A)
- ⑨ n.c.

X1

- + ① + DC 24 V
- ② 0 V

214-1BC03



MP²

- ① reserved
- ② M24V
- ③ RxD/TxD-P (line B)
- ④ RTS
- ⑤ M5V
- ⑥ P5V
- ⑦ P24V
- ⑧ RxD/TxD-N (line A)
- ⑨ n.c.

X1

- + ① + DC 24 V
- ② 0 V

214-1BC06



MP²



- ① reserved
- ② M24V
- ③ RxD/TxD-P (line B)
- ④ RTS
- ⑤ M5V
- ⑥ P5V
- ⑦ P24V
- ⑧ RxD/TxD-N (line A)
- ⑨ n.c.

X1

- + ① + DC 24 V
- ② 0 V

CPUs STEP7 programmable, standard

CPUs CPUs STEP7 programmable, standard					
214-1BA03	215-1BA03				
214-1BA06	215-1BA06				
214-1BC03					
214-1BC06					

Order number	215-1BA03	215-1BA06		
Figure				
Type	CPU 215	CPU 215		
General information				
Note	-	-		
Features	<ul style="list-style-type: none"> ▸ 128 kB work memory ▸ 192 kB load memory 	<ul style="list-style-type: none"> ▸ 128 kB work memory ▸ 192 kB load memory ▸ Also configurable via TIA-Portal 		
Technical data power supply				
Power supply (rated value)	DC 24 V	DC 24 V		
Power supply (permitted range)	DC 20.4...28.8 V	DC 20.4...28.8 V		
Reverse polarity protection	✓	✓		
Current consumption (no-load operation)	50 mA	50 mA		
Current consumption (rated value)	1.5 A	1.5 A		
Inrush current	65 A	65 A		
I ² t	0.75 A ² s	0.75 A ² s		
Max. current drain at backplane bus	3 A	3 A		
Power loss	3.5 W	3.5 W		
Load and working memory				
Load memory, integrated	192 KB	192 KB		
Load memory, maximum	192 KB	192 KB		
Work memory, integrated	128 KB	128 KB		
Work memory, maximal	128 KB	128 KB		
Memory divided in 50% program / 50% data	-	-		
Memory card slot	MMC-Card with max. 512 MB	MMC-Card with max. 512 MB		
Hardware configuration				
Racks, max.	4	4		
Modules per rack, max.	total max. 32	total max. 32		
Number of integrated DP master	-	-		
Number of DP master via CP	8	8		
Operable function modules	32	32		
Operable communication modules PtP	32	32		
Operable communication modules LAN	-	-		
Command processing times				
Bit instructions, min.	0.18 µs	0.18 µs		
Word instruction, min.	0.78 µs	0.78 µs		
Double integer arithmetic, min.	1.8 µs	1.8 µs		
Floating-point arithmetic, min.	40 µs	40 µs		

SLIO
100V
200V
300S
500S
HMI
Teleservice
StarterKits
Safety
Solutions
Software
Accessories
Appendix

CPUs CPUs STEP7 programmable, standard					
214-1BA03	215-1BA03				
214-1BA06	215-1BA06				
214-1BC03					
214-1BC06					

Order number	215-1BA03	215-1BA06		
Timers/Counters and their retentive characteristics				
Number of S7 counters	256	256		
S7 counter remanence	adjustable 0 up to 64	adjustable 0 up to 64		
S7 counter remanence adjustable	C0 .. C7	C0 .. C7		
Number of S7 times	256	256		
S7 times remanence	adjustable 0 up to 128	adjustable 0 up to 128		
S7 times remanence adjustable	not retentive	not retentive		
Data range and retentive characteristic				
Number of flags	8192 Bit	8192 Bit		
Bit memories retentive characteristic adjustable	adjustable 0 up to 256	adjustable 0 up to 256		
Bit memories retentive characteristic preset	MB0 .. MB15	MB0 .. MB15		
Number of data blocks	2047	2047		
Max. data blocks size	16 KB	16 KB		
Number range DBs	1 ... 2047	1 ... 2047		
Max. local data size per execution level	1024 Byte	1024 Byte		
Max. local data size per block	1024 Byte	1024 Byte		
Blocks				
Number of OBs	14	14		
Maximum OB size	16 KB	16 KB		
Total number DBs, FBs, FCs	-	-		
Number of FBs	1024	1024		
Maximum FB size	16 KB	16 KB		
Number range FBs	0 ... 1023	0 ... 1023		
Number of FCs	1024	1024		
Maximum FC size	16 KB	16 KB		
Number range FC2	0 ... 1023	0 ... 1023		
Maximum nesting depth per priority class	8	8		
Maximum nesting depth additional within an error OB	1	1		
Time				
Real-time clock buffered	✓	✓		
Clock buffered period (min.)	30 d	30 d		
Type of buffering	-	-		
Load time for 50% buffering period	20 h	20 h		
Load time for 100% buffering period	48 h	48 h		
Accuracy (max. deviation per day)	10 s	10 s		
Number of operating hours counter	8	8		
Clock synchronization	-	-		
Synchronization via MPI	-	-		
Synchronization via Ethernet (NTP)	-	-		

SLIO
100V
200V
300S
500S
HMI
Teleservice
StarterKits
Safety
Solutions
Software
Accessories
Appendix

CPUs CPUs STEP7 programmable, standard						
214-1BA03	215-1BA03					
214-1BA06	215-1BA06					
214-1BC03						
214-1BC06						

Order number	215-1BA03	215-1BA06		
Address areas (I/O)				
Input I/O address area	1024 Byte	1024 Byte		
Output I/O address area	1024 Byte	1024 Byte		
Process image adjustable	-	-		
Input process image preset	128 Byte	128 Byte		
Output process image preset	128 Byte	128 Byte		
Input process image maximal	128 Byte	128 Byte		
Output process image maximal	128 Byte	128 Byte		
Digital inputs	8192	8192		
Digital outputs	8192	8192		
Digital inputs central	512	512		
Digital outputs central	512	512		
Integrated digital inputs	-	-		
Integrated digital outputs	-	-		
Analog inputs	512	512		
Analog outputs	512	512		
Analog inputs, central	128	128		
Analog outputs, central	128	128		
Integrated analog inputs	-	-		
Integrated analog outputs	-	-		
Communication functions				
PG/OP channel	✓	✓		
Global data communication	✓	✓		
Number of GD circuits, max.	4	4		
Size of GD packets, max.	22 Byte	22 Byte		
S7 basic communication	✓	✓		
S7 basic communication, user data per job	76 Byte	76 Byte		
S7 communication	✓	✓		
S7 communication as server	✓	✓		
S7 communication as client	-	-		
S7 communication, user data per job	160 Byte	160 Byte		
Number of connections, max.	16	16		
Functionality Sub-D interfaces				
Type	MP ² I	MP ² I		
Type of interface	RS485	RS485		
Connector	Sub-D, 9-pin, female	Sub-D, 9-pin, female		
Electrically isolated	-	-		
MPI	✓	✓		
MP ² I (MPI/RS232)	✓	✓		
Point-to-point interface	-	-		

CPUs CPUs STEP7 programmable, standard						
214-1BA03	215-1BA03					
214-1BA06	215-1BA06					
214-1BC03						
214-1BC06						

Order number	215-1BA03	215-1BA06		
Functionality MPI				
Number of connections, max.	16	16		
PG/OP channel	✓	✓		
Routing	-	-		
Global data communication	✓	✓		
S7 basic communication	✓	✓		
S7 communication	✓	✓		
S7 communication as server	✓	✓		
S7 communication as client	-	-		
Transmission speed, min.	19.2 kbit/s	19.2 kbit/s		
Transmission speed, max.	187.5 kbit/s	187.5 kbit/s		
Datasizes				
Input bytes	0	0		
Output bytes	0	0		
Parameter bytes	3	3		
Diagnostic bytes	0	0		
Housing				
Material	PPE / PA 6.6	PPE / PA 6.6		
Mounting	Profile rail 35 mm	Profile rail 35 mm		
Mechanical data				
Dimensions (WxHxD)	25.4 mm x 76 mm x 80 mm	25.4 mm x 76 mm x 80 mm		
Weight	100 g	100 g		
Environmental conditions				
Operating temperature	0 °C to 60 °C	0 °C to 60 °C		
Storage temperature	-25 °C to 70 °C	-25 °C to 70 °C		
Certifications				
UL508 certification	yes	in preparation		

SLIO
100V
200V
300S
500S
HMI
Teleservice
StarterKits
Safety
Solutions
Software
Accessories
Appendix

Connections, Interfaces

CPU CPUs STEP7 programmable, standard					
214-1BA03	215-1BA03				
214-1BA06	215-1BA06				
214-1BC03					
214-1BC06					

215-1BA03



MP1

- ① reserved
- ② M24V
- ③ Rx/D/TxD-P (line B)
- ④ RTS
- ⑤ M5V
- ⑥ P5V
- ⑦ P24V
- ⑧ Rx/D/TxD-N (line A)
- ⑨ n.c.

X1

- + ① + DC 24 V
- ② 0 V

215-1BA06



MP1

- ① reserved
- ② M24V
- ③ Rx/D/TxD-P (line B)
- ④ RTS
- ⑤ M5V
- ⑥ P5V
- ⑦ P24V
- ⑧ Rx/D/TxD-N (line A)
- ⑨ n.c.

X1

- + ① + DC 24 V
- ② 0 V

CPUs STEP7 programmable, NET-CPUs

CPUs CPUs STEP7 programmable, NET-CPUs					
214-2BE03					
214-2BT13					
215-2BE03					
215-2BT13					

Order number	214-2BE03	214-2BT13	215-2BE03	215-2BT13
Figure				
Type	CPU 214NET	CPU 214NET	CPU 215NET	CPU 215NET
General information				
Note	-	-	-	-
Features	<ul style="list-style-type: none"> ▶ Twisted pair Ethernet via RJ45 ▶ 96 kB work memory ▶ 144 kB load memory 	<ul style="list-style-type: none"> ▶ Ethernet CP 243 ▶ Twisted pair Ethernet via RJ45 ▶ 96 kB work memory ▶ 144 kB load memory 	<ul style="list-style-type: none"> ▶ Twisted pair Ethernet via RJ45 ▶ 128 kB work memory ▶ 192 kB load memory 	<ul style="list-style-type: none"> ▶ Ethernet CP 243 ▶ Twisted pair Ethernet via RJ45 ▶ 128 kB work memory ▶ 192 kB load memory
Technical data power supply				
Power supply (rated value)	DC 24 V	DC 24 V	DC 24 V	DC 24 V
Power supply (permitted range)	DC 20.4...28.8 V	DC 20.4...28.8 V	DC 20.4...28.8 V	DC 20.4...28.8 V
Reverse polarity protection	✓	✓	✓	✓
Current consumption (no-load operation)	140 mA	140 mA	140 mA	140 mA
Current consumption (rated value)	1.5 A	1.5 A	1.5 A	1.5 A
Inrush current	65 A	65 A	65 A	65 A
I²t	0.75 A²s	0.75 A²s	0.75 A²s	0.75 A²s
Max. current drain at backplane bus	3 A	3 A	3 A	3 A
Power loss	6 W	6 W	6 W	6 W
Load and working memory				
Load memory, integrated	144 KB	144 KB	192 KB	192 KB
Load memory, maximum	144 KB	144 KB	192 KB	192 KB
Work memory, integrated	96 KB	96 KB	128 KB	128 KB
Work memory, maximal	96 KB	96 KB	128 KB	128 KB
Memory divided in 50% program / 50% data	-	-	-	-
Memory card slot	MMC-Card with max. 512 MB	MMC-Card with max. 512 MB	MMC-Card with max. 512 MB	MMC-Card with max. 512 MB
Hardware configuration				
Racks, max.	4	4	4	4
Modules per rack, max.	total max. 32	total max. 32	total max. 32	total max. 32
Number of integrated DP master	-	-	-	-
Number of DP master via CP	8	8	8	8
Operable function modules	32	32	32	32
Operable communication modules PtP	32	32	32	32
Operable communication modules LAN	-	-	-	-

CPUs CPUs STEP7 programmable, NET-CPU					
214-2BE03					
214-2BT13					
215-2BE03					
215-2BT13					

Order number	214-2BE03	214-2BT13	215-2BE03	215-2BT13
Command processing times				
Bit instructions, min.	0.18 µs	0.18 µs	0.18 µs	0.18 µs
Word instruction, min.	0.78 µs	0.78 µs	0.78 µs	0.78 µs
Double integer arithmetic, min.	1.8 µs	1.8 µs	1.8 µs	1.8 µs
Floating-point arithmetic, min.	40 µs	40 µs	40 µs	40 µs
Timers/Counters and their retentive characteristics				
Number of S7 counters	256	256	256	256
S7 counter remanence	adjustable 0 up to 64	adjustable 0 up to 64	adjustable 0 up to 64	adjustable 0 up to 64
S7 counter remanence adjustable	C0 .. C7	C0 .. C7	C0 .. C7	C0 .. C7
Number of S7 times	256	256	256	256
S7 times remanence	adjustable 0 up to 128	adjustable 0 up to 128	adjustable 0 up to 128	adjustable 0 up to 128
S7 times remanence adjustable	not retentive	not retentive	not retentive	not retentive
Data range and retentive characteristic				
Number of flags	8192 Bit	8192 Bit	8192 Bit	8192 Bit
Bit memories retentive characteristic adjustable	adjustable 0 up to 256	adjustable 0 up to 256	adjustable 0 up to 256	adjustable 0 up to 256
Bit memories retentive characteristic preset	MB0 .. MB15	MB0 .. MB15	MB0 .. MB15	MB0 .. MB15
Number of data blocks	2047	2047	2047	2047
Max. data blocks size	16 KB	16 KB	16 KB	16 KB
Number range DBs	1 ... 2047	1 ... 2047	1 ... 2047	1 ... 2047
Max. local data size per execution level	1024 Byte	1024 Byte	1024 Byte	1024 Byte
Max. local data size per block	1024 Byte	1024 Byte	1024 Byte	1024 Byte
Blocks				
Number of OBs	14	14	14	14
Maximum OB size	16 KB	16 KB	16 KB	16 KB
Total number DBs, FBs, FCs	-	-	-	-
Number of FBs	1024	1024	1024	1024
Maximum FB size	16 KB	16 KB	16 KB	16 KB
Number range FBs	0 ... 1023	0 ... 1023	0 ... 1023	0 ... 1023
Number of FCs	1024	1024	1024	1024
Maximum FC size	16 KB	16 KB	16 KB	16 KB
Number range FC2	0 ... 1023	0 ... 1023	0 ... 1023	0 ... 1023
Maximum nesting depth per priority class	8	8	8	8
Maximum nesting depth additional within an error OB	1	1	1	1
Time				
Real-time clock buffered	✓	✓	✓	✓
Clock buffered period (min.)	30 d	30 d	30 d	30 d
Type of buffering	-	-	-	-
Load time for 50% buffering period	20 h	20 h	20 h	20 h
Load time for 100% buffering period	48 h	48 h	48 h	48 h

SLIO
100V
200V
300S
500S
HMI
Teleservice
StarterKits
Safety
Solutions
Software
Accessories
Appendix

CPU CPU STEP7 programmable, NET-CPU					
214-2BE03					
214-2BT13					
215-2BE03					
215-2BT13					

Order number	214-2BE03	214-2BT13	215-2BE03	215-2BT13
Accuracy (max. deviation per day)	10 s	10 s	10 s	10 s
Number of operating hours counter	8	8	8	8
Clock synchronization	-	-	-	-
Synchronization via MPI	-	-	-	-
Synchronization via Ethernet (NTP)	-	-	-	-
Address areas (I/O)				
Input I/O address area	1024 Byte	1024 Byte	1024 Byte	1024 Byte
Output I/O address area	1024 Byte	1024 Byte	1024 Byte	1024 Byte
Process image adjustable	-	-	-	-
Input process image preset	128 Byte	128 Byte	128 Byte	128 Byte
Output process image preset	128 Byte	128 Byte	128 Byte	128 Byte
Input process image maximal	128 Byte	128 Byte	128 Byte	128 Byte
Output process image maximal	128 Byte	128 Byte	128 Byte	128 Byte
Digital inputs	8192	8192	8192	8192
Digital outputs	8192	8192	8192	8192
Digital inputs central	512	512	512	512
Digital outputs central	512	512	512	512
Integrated digital inputs	-	-	-	-
Integrated digital outputs	-	-	-	-
Analog inputs	512	512	512	512
Analog outputs	512	512	512	512
Analog inputs, central	128	128	128	128
Analog outputs, central	128	128	128	128
Integrated analog inputs	-	-	-	-
Integrated analog outputs	-	-	-	-
Communication functions				
PG/OP channel	✓	✓	✓	✓
Global data communication	✓	✓	✓	✓
Number of GD circuits, max.	4	4	4	4
Size of GD packets, max.	22 Byte	22 Byte	22 Byte	22 Byte
S7 basic communication	✓	✓	✓	✓
S7 basic communication, user data per job	76 Byte	76 Byte	76 Byte	76 Byte
S7 communication	✓	✓	✓	✓
S7 communication as server	✓	✓	✓	✓
S7 communication as client	-	-	-	-
S7 communication, user data per job	160 Byte	160 Byte	160 Byte	160 Byte
Number of connections, max.	16	16	16	16
Functionality Sub-D interfaces				
Type	MP2I	MP2I	MP2I	MP2I
Type of interface	RS485	RS485	RS485	RS485
Connector	Sub-D, 9-pin, female	Sub-D, 9-pin, female	Sub-D, 9-pin, female	Sub-D, 9-pin, female
Electrically isolated	-	-	-	-
MPI	✓	✓	✓	✓
MP2I (MPI/RS232)	✓	✓	✓	✓
Point-to-point interface	-	-	-	-

SLIO
100V
200V
300S
500S
HMI
Teleservice
StarterKits
Safety
Solutions
Software
Accessories
Appendix

CPU CPUs STEP7 programmable, NET-CPU						
214-2BE03						
214-2BT13						
215-2BE03						
215-2BT13						

Order number	214-2BE03	214-2BT13	215-2BE03	215-2BT13
Functionality MPI				
Number of connections, max.	16	16	16	16
PG/OP channel	✓	✓	✓	✓
Routing	-	-	-	-
Global data communication	✓	✓	✓	✓
S7 basic communication	✓	✓	✓	✓
S7 communication	✓	✓	✓	✓
S7 communication as server	✓	✓	✓	✓
S7 communication as client	-	-	-	-
Transmission speed, min.	19.2 kbit/s	19.2 kbit/s	19.2 kbit/s	19.2 kbit/s
Transmission speed, max.	187.5 kbit/s	187.5 kbit/s	187.5 kbit/s	187.5 kbit/s
Functionality RJ45 interfaces				
Type	TP	TP	TP	TP
Type of interface	Ethernet 10/100 MBit	Ethernet 10/100 MBit	Ethernet 10/100 MBit	Ethernet 10/100 MBit
Connector	RJ45	RJ45	RJ45	RJ45
Electrically isolated	✓	✓	✓	✓
PG/OP channel	✓	✓	✓	✓
Number of connections, max.	8	8	8	8
Productive connections	✓	✓	✓	✓
Ethernet communication CP				
Number of productive connections, max.	16	16	16	16
Number of productive connections by Siemens NetPro, max.	16	16	16	16
S7 connections	-	-	-	-
User data per S7 connection, max.	-	-	-	-
TCP-connections	FETCH PASSIV, WRITE PASSIV, Connection of passive data handling	SEND, RECEIVE, FETCH PASSIV, WRITE PASSIV, Connection of active and passive data handling	FETCH PASSIV, WRITE PASSIV, Connection of passive data handling	SEND, RECEIVE, FETCH PASSIV, WRITE PASSIV, Connection of active and passive data handling
User data per TCP connection, max.	64 KB	64 KB	64 KB	64 KB
ISO-connections	-	SEND and RECEIVE	-	SEND and RECEIVE
User data per ISO connection, max.	-	8 KB	-	8 KB
ISO on TCP connections (RFC 1006)	FETCH PASSIV, WRITE PASSIV, Connection of passive data handling	SEND, RECEIVE, FETCH PASSIV, WRITE PASSIV, Connection of active and passive data handling	FETCH PASSIV, WRITE PASSIV, Connection of passive data handling	SEND, RECEIVE, FETCH PASSIV, WRITE PASSIV, Connection of active and passive data handling
User data per ISO on TCP connection, max.	32 KB	32 KB	32 KB	32 KB
UDP-connections	-	SEND and RECEIVE	-	SEND and RECEIVE
User data per UDP connection, max.	-	2 KB	-	2 KB
UDP-multicast-connections	-	SEND and RECEIVE (max. 16 Multicast groups)	-	SEND and RECEIVE (max. 16 Multicast groups)
UDP-broadcast-connections	-	SEND	-	SEND

SLIO
100V
200V
300S
500S
HMI
Teleservice
StarterKits
Safety
Solutions
Software
Accessories
Appendix

CPU CPU STEP7 programmable, NET-CPU					
214-2BE03					
214-2BT13					
215-2BE03					
215-2BT13					

Order number	214-2BE03	214-2BT13	215-2BE03	215-2BT13
Datasizes				
Input bytes	0	0	0	0
Output bytes	0	0	0	0
Parameter bytes	3	3	3	3
Diagnostic bytes	0	0	0	0
Housing				
Material	PPE / PA 6.6	PPE / PA 6.6	PPE / PA 6.6	PPE / PA 6.6
Mounting	Profile rail 35 mm	Profile rail 35 mm	Profile rail 35 mm	Profile rail 35 mm
Mechanical data				
Dimensions (WxHxD)	50.8 mm x 76 mm x 80 mm	50.8 mm x 76 mm x 80 mm	50.8 mm x 76 mm x 80 mm	50.8 mm x 76 mm x 80 mm
Weight	150 g	150 g	150 g	150 g
Environmental conditions				
Operating temperature	0 °C to 60 °C	0 °C to 60 °C	0 °C to 60 °C	0 °C to 60 °C
Storage temperature	-25 °C to 70 °C	-25 °C to 70 °C	-25 °C to 70 °C	-25 °C to 70 °C
Certifications				
UL508 certification	yes	yes	yes	yes

Connections, Interfaces

CPU | CPUs STEP7 programmable, NET-CPU

214-2BE03
214-2BT13
215-2BE03
215-2BT13

214-2BE03

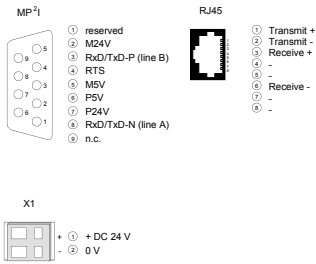

214-2BT13

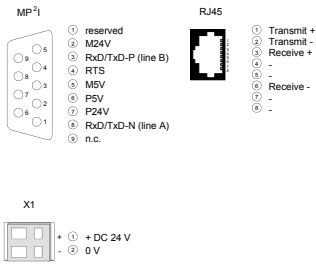

215-2BE03

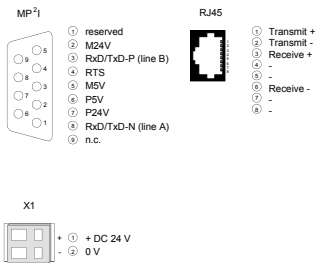



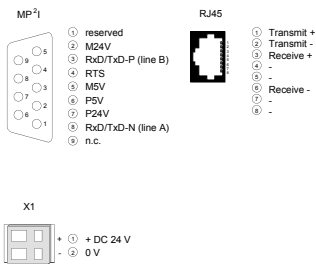

215-2BT13



CPU STEP7 programmable, PtP

CPU STEP7 programmable, PtP

214-2BS03 214-2BS13 214-2BS33 215-2BS03	215-2BS13 215-2BS33				
--	------------------------	--	--	--	--

Order number	214-2BS03	214-2BS13	214-2BS33	215-2BS03
Figure				
Type	CPU 214SER	CPU 214SER	CPU 214SER	CPU 215SER
General information				
Note	-	-	-	-
Features	<ul style="list-style-type: none"> Serial communication via 2x RS232 96 kB work memory 144 kB load memory 	<ul style="list-style-type: none"> Serial communication via RS232 96 kB work memory 144 kB load memory 	<ul style="list-style-type: none"> Serial communication via RS485 96 kB work memory 144 kB load memory 	<ul style="list-style-type: none"> Serial communication via 2x RS232 128 kB work memory 192 kB load memory
Technical data power supply				
Power supply (rated value)	DC 24 V	DC 24 V	DC 24 V	DC 24 V
Power supply (permitted range)	DC 20.4...28.8 V	DC 20.4...28.8 V	DC 20.4...28.8 V	DC 20.4...28.8 V
Reverse polarity protection	✓	✓	✓	✓
Current consumption (no-load operation)	90 mA	90 mA	80 mA	90 mA
Current consumption (rated value)	1.5 A	1.5 A	1.5 A	1.5 A
Inrush current	65 A	65 A	65 A	65 A
I ² t	0.75 A ² s	0.75 A ² s	0.75 A ² s	0.75 A ² s
Max. current drain at backplane bus	3 A	3 A	3 A	3 A
Power loss	5 W	5 W	5 W	5 W
Load and working memory				
Load memory, integrated	144 KB	144 KB	144 KB	192 KB
Load memory, maximum	144 KB	144 KB	144 KB	192 KB
Work memory, integrated	96 KB	96 KB	96 KB	128 KB
Work memory, maximal	96 KB	96 KB	96 KB	128 KB
Memory divided in 50% program / 50% data	-	-	-	-
Memory card slot	MMC-Card with max. 512 MB	MMC-Card with max. 512 MB	MMC-Card with max. 512 MB	MMC-Card with max. 512 MB
Hardware configuration				
Racks, max.	4	4	4	4
Modules per rack, max.	total max. 32	total max. 32	total max. 32	total max. 32
Number of integrated DP master	-	-	-	-
Number of DP master via CP	8	8	8	8
Operable function modules	32	32	32	32
Operable communication modules PtP	32	32	32	32
Operable communication modules LAN	-	-	-	-
Command processing times				
Bit instructions, min.	0.18 µs	0.18 µs	0.18 µs	0.18 µs
Word instruction, min.	0.78 µs	0.78 µs	0.78 µs	0.78 µs
Double integer arithmetic, min.	1.8 µs	1.8 µs	1.8 µs	1.8 µs
Floating-point arithmetic, min.	40 µs	40 µs	40 µs	40 µs

CPUs CPUs STEP7 programmable, PtP					
214-2BS03	215-2BS13				
214-2BS13	215-2BS33				
214-2BS33					
215-2BS03					

Order number	214-2BS03	214-2BS13	214-2BS33	215-2BS03
Timers/Counters and their retentive characteristics				
Number of S7 counters	256	256	256	256
S7 counter remanence	adjustable 0 up to 64	adjustable 0 up to 64	adjustable 0 up to 64	adjustable 0 up to 64
S7 counter remanence adjustable	C0 .. C7	C0 .. C7	C0 .. C7	C0 .. C7
Number of S7 times	256	256	256	256
S7 times remanence	adjustable 0 up to 128	adjustable 0 up to 128	adjustable 0 up to 128	adjustable 0 up to 128
S7 times remanence adjustable	not retentive	not retentive	not retentive	not retentive
Data range and retentive characteristic				
Number of flags	8192 Bit	8192 Bit	8192 Bit	8192 Bit
Bit memories retentive characteristic adjustable	adjustable 0 up to 256	adjustable 0 up to 256	adjustable 0 up to 256	adjustable 0 up to 256
Bit memories retentive characteristic preset	MB0 .. MB15	MB0 .. MB15	MB0 .. MB15	MB0 .. MB15
Number of data blocks	2047	2047	2047	2047
Max. data blocks size	16 KB	16 KB	16 KB	16 KB
Number range DBs	1 ... 2047	1 ... 2047	1 ... 2047	1 ... 2047
Max. local data size per execution level	1024 Byte	1024 Byte	1024 Byte	1024 Byte
Max. local data size per block	1024 Byte	1024 Byte	1024 Byte	1024 Byte
Blocks				
Number of OBs	14	14	14	14
Maximum OB size	16 KB	16 KB	16 KB	16 KB
Totalnumber DBs, FBs, FCs	-	-	-	-
Number of FBs	1024	1024	1024	1024
Maximum FB size	16 KB	16 KB	16 KB	16 KB
Number range FBs	0 ... 1023	0 ... 1023	0 ... 1023	0 ... 1023
Number of FCs	1024	1024	1024	1024
Maximum FC size	16 KB	16 KB	16 KB	16 KB
Number range FC2	0 ... 1023	0 ... 1023	0 ... 1023	0 ... 1023
Maximum nesting depth per priority class	8	8	8	8
Maximum nesting depth additional within an error OB	1	1	1	1
Time				
Real-time clock buffered	✓	✓	✓	✓
Clock buffered period (min.)	30 d	30 d	30 d	30 d
Type of buffering	-	-	-	-
Load time for 50% buffering period	20 h	20 h	20 h	20 h
Load time for 100% buffering period	48 h	48 h	48 h	48 h
Accuracy (max. deviation per day)	10 s	10 s	10 s	10 s
Number of operating hours counter	8	8	8	8
Clock synchronization	-	-	-	-
Synchronization via MPI	-	-	-	-
Synchronization via Ethernet (NTP)	-	-	-	-

SLIO
100V
200V
300S
500S
HMI
Teleservice
StarterKits
Safety
Solutions
Software
Accessories
Appendix

CPUs CPUs STEP7 programmable, PtP					
214-2BS03	215-2BS13				
214-2BS13	215-2BS33				
214-2BS33					
215-2BS03					

Order number	214-2BS03	214-2BS13	214-2BS33	215-2BS03
Address areas (I/O)				
Input I/O address area	1024 Byte	1024 Byte	1024 Byte	1024 Byte
Output I/O address area	1024 Byte	1024 Byte	1024 Byte	1024 Byte
Process image adjustable	-	-	-	-
Input process image preset	128 Byte	128 Byte	128 Byte	128 Byte
Output process image preset	128 Byte	128 Byte	128 Byte	128 Byte
Input process image maximal	128 Byte	128 Byte	128 Byte	128 Byte
Output process image maximal	128 Byte	128 Byte	128 Byte	128 Byte
Digital inputs	8192	8192	8192	8192
Digital outputs	8192	8192	8192	8192
Digital inputs central	512	512	512	512
Digital outputs central	512	512	512	512
Integrated digital inputs	-	-	-	-
Integrated digital outputs	-	-	-	-
Analog inputs	512	512	512	512
Analog outputs	512	512	512	512
Analog inputs, central	128	128	128	128
Analog outputs, central	128	128	128	128
Integrated analog inputs	-	-	-	-
Integrated analog outputs	-	-	-	-
Communication functions				
PG/OP channel	✓	✓	✓	✓
Global data communication	✓	✓	✓	✓
Number of GD circuits, max.	4	4	4	4
Size of GD packets, max.	22 Byte	22 Byte	22 Byte	22 Byte
S7 basic communication	✓	✓	✓	✓
S7 basic communication, user data per job	76 Byte	76 Byte	76 Byte	76 Byte
S7 communication	✓	✓	✓	✓
S7 communication as server	✓	✓	✓	✓
S7 communication as client	-	-	-	-
S7 communication, user data per job	160 Byte	160 Byte	160 Byte	160 Byte
Number of connections, max.	16	16	16	16
Functionality Sub-D interfaces				
Type	MP2I	MP2I	MP2I	MP2I
Type of interface	RS485	RS485	RS485	RS485
Connector	Sub-D, 9-pin, female	Sub-D, 9-pin, female	Sub-D, 9-pin, female	Sub-D, 9-pin, female
Electrically isolated	-	-	-	-
MPI	✓	✓	✓	✓
MP2I (MPI/RS232)	✓	✓	✓	✓
Point-to-point interface	-	-	-	-

SLIO
100V
200V
300S
500S
HMI
Teleservice
StarterKits
Safety
Solutions
Software
Accessories
Appendix

CPU CPU STEP7 programmable, PtP					
214-2BS03	215-2BS13				
214-2BS13	215-2BS33				
214-2BS33					
215-2BS03					

Order number	214-2BS03	214-2BS13	214-2BS33	215-2BS03
Type	COM1	COM	COM	COM1
Type of interface	RS232	RS232	RS485	RS232
Connector	Sub-D, 9-pin, male	Sub-D, 9-pin, male	Sub-D, 9-pin, female	Sub-D, 9-pin, male
Electrically isolated	-	-	✓	-
MPI	-	-	-	-
MP ² (MPI/RS232)	-	-	-	-
Point-to-point interface	✓	✓	✓	✓
Type	COM2	-	-	COM2
Type of interface	RS232	-	-	RS232
Connector	Sub-D, 9-pin, male	-	-	Sub-D, 9-pin, male
Electrically isolated	-	-	-	-
MPI	-	-	-	-
MP ² (MPI/RS232)	-	-	-	-
Point-to-point interface	✓	-	-	✓
Functionality MPI				
Number of connections, max.	16	16	16	16
PG/OP channel	✓	✓	✓	✓
Routing	-	-	-	-
Global data communication	✓	✓	✓	✓
S7 basic communication	✓	✓	✓	✓
S7 communication	✓	✓	✓	✓
S7 communication as server	✓	✓	✓	✓
S7 communication as client	-	-	-	-
Transmission speed, min.	19.2 kbit/s	19.2 kbit/s	19.2 kbit/s	19.2 kbit/s
Transmission speed, max.	187.5 kbit/s	187.5 kbit/s	187.5 kbit/s	187.5 kbit/s
Point-to-point communication				
PtP communication	✓	✓	✓	✓
Interface isolated	-	-	✓	-
RS232 interface	✓	✓	-	✓
RS422 interface	-	-	-	-
RS485 interface	-	-	✓	-
Connector	Sub-D, 9-pin, male	Sub-D, 9-pin, male	Sub-D, 9-pin, female	Sub-D, 9-pin, male
Transmission speed, min.	150 bit/s	150 bit/s	150 bit/s	150 bit/s
Transmission speed, max.	115.2 kbit/s	115.2 kbit/s	115.2 kbit/s	115.2 kbit/s
Cable length, max.	15 m	15 m	500 m	15 m
Point-to-point protocol				
ASCII protocol	✓	✓	✓	✓
STX/ETX protocol	✓	✓	✓	✓
3964(R) protocol	✓	✓	✓	✓
RK512 protocol	✓	-	-	✓
USS master protocol	-	✓	✓	-
Modbus master protocol	-	✓	✓	-
Modbus slave protocol	-	✓	✓	-
Special protocols	-	-	-	-

CPU CPU STEP7 programmable, PtP					
214-2BS03	215-2BS13				
214-2BS13	215-2BS33				
214-2BS33					
215-2BS03					

Order number	214-2BS03	214-2BS13	214-2BS33	215-2BS03
Datasizes				
Input bytes	0	0	0	0
Output bytes	0	0	0	0
Parameter bytes	3	3	3	3
Diagnostic bytes	0	0	0	0
Housing				
Material	PPE / PA 6.6	PPE / PA 6.6	PPE / PA 6.6	PPE / PA 6.6
Mounting	Profile rail 35 mm	Profile rail 35 mm	Profile rail 35 mm	Profile rail 35 mm
Mechanical data				
Dimensions (WxHxD)	50.8 mm x 76 mm x 80 mm	50.8 mm x 76 mm x 80 mm	50.8 mm x 76 mm x 80 mm	50.8 mm x 76 mm x 80 mm
Weight	150 g	150 g	150 g	150 g
Environmental conditions				
Operating temperature	0 °C to 60 °C	0 °C to 60 °C	0 °C to 60 °C	0 °C to 60 °C
Storage temperature	-25 °C to 70 °C	-25 °C to 70 °C	-25 °C to 70 °C	-25 °C to 70 °C
Certifications				
UL508 certification	yes	yes	yes	yes

Connections, Interfaces

CPU | CPUs STEP7 programmable, PtP

214-2BS03
214-2BS13
214-2BS33
215-2BS03

215-2BS13
215-2BS33

214-2BS03

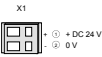
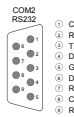
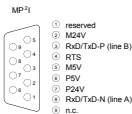
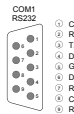

214-2BS13

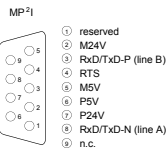
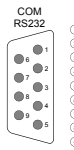

214-2BS33

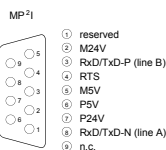
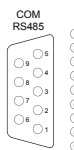

215-2BS03

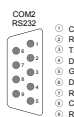
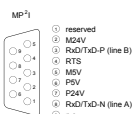
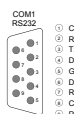

CPUs STEP7 programmable, PtP

CPUs CPUs STEP7 programmable, PtP					
214-2BS03	215-2BS13				
214-2BS13	215-2BS33				
214-2BS33					
215-2BS03					

Order number	215-2BS13	215-2BS33		
Figure				
Type	CPU 215SER	CPU 215SER		
General information				
Note	-	-		
Features	<ul style="list-style-type: none"> ▸ Serial communication via RS232 ▸ 128 kB work memory ▸ 192 kB load memory 	<ul style="list-style-type: none"> ▸ Serial communication via RS485 ▸ 128 kB work memory ▸ 192 kB load memory 		
Technical data power supply				
Power supply (rated value)	DC 24 V	DC 24 V		
Power supply (permitted range)	DC 20.4...28.8 V	DC 20.4...28.8 V		
Reverse polarity protection	✓	✓		
Current consumption (no-load operation)	90 mA	80 mA		
Current consumption (rated value)	1.5 A	1.5 A		
Inrush current	65 A	65 A		
I ² t	0.75 A ² s	0.75 A ² s		
Max. current drain at backplane bus	3 A	3 A		
Power loss	5 W	5 W		
Load and working memory				
Load memory, integrated	192 KB	192 KB		
Load memory, maximum	192 KB	192 KB		
Work memory, integrated	128 KB	128 KB		
Work memory, maximal	128 KB	128 KB		
Memory divided in 50% program / 50% data	-	-		
Memory card slot	MMC-Card with max. 512 MB	MMC-Card with max. 512 MB		
Hardware configuration				
Racks, max.	4	4		
Modules per rack, max.	total max. 32	total max. 32		
Number of integrated DP master	-	-		
Number of DP master via CP	8	8		
Operable function modules	32	32		
Operable communication modules PtP	32	32		
Operable communication modules LAN	-	-		
Command processing times				
Bit instructions, min.	0.18 µs	0.18 µs		
Word instruction, min.	0.78 µs	0.78 µs		
Double integer arithmetic, min.	1.8 µs	1.8 µs		
Floating-point arithmetic, min.	40 µs	40 µs		

SLIO
 100V
 200V
 300S
 500S
 HMI
 Teleservice
 StarterKits
 Safety
 Solutions
 Software
 Accessories
 Appendix

CPU CPU STEP7 programmable, PtP					
214-2BS03	215-2BS13				
214-2BS13	215-2BS33				
214-2BS33					
215-2BS03					

Order number	215-2BS13	215-2BS33		
Timers/Counters and their retentive characteristics				
Number of S7 counters	256	256		
S7 counter remanence	adjustable 0 up to 64	adjustable 0 up to 64		
S7 counter remanence adjustable	C0 .. C7	C0 .. C7		
Number of S7 times	256	256		
S7 times remanence	adjustable 0 up to 128	adjustable 0 up to 128		
S7 times remanence adjustable	not retentive	not retentive		
Data range and retentive characteristic				
Number of flags	8192 Bit	8192 Bit		
Bit memories retentive characteristic adjustable	adjustable 0 up to 256	adjustable 0 up to 256		
Bit memories retentive characteristic preset	MB0 .. MB15	MB0 .. MB15		
Number of data blocks	2047	2047		
Max. data blocks size	16 KB	16 KB		
Number range DBs	1 ... 2047	1 ... 2047		
Max. local data size per execution level	1024 Byte	1024 Byte		
Max. local data size per block	1024 Byte	1024 Byte		
Blocks				
Number of OBs	14	14		
Maximum OB size	16 KB	16 KB		
Totalnumber DBs, FBs, FCs	-	-		
Number of FBs	1024	1024		
Maximum FB size	16 KB	16 KB		
Number range FBs	0 ... 1023	0 ... 1023		
Number of FCs	1024	1024		
Maximum FC size	16 KB	16 KB		
Number range FC2	0 ... 1023	0 ... 1023		
Maximum nesting depth per priority class	8	8		
Maximum nesting depth additional within an error OB	1	1		
Time				
Real-time clock buffered	✓	✓		
Clock buffered period (min.)	30 d	30 d		
Type of buffering	-	-		
Load time for 50% buffering period	20 h	20 h		
Load time for 100% buffering period	48 h	48 h		
Accuracy (max. deviation per day)	10 s	10 s		
Number of operating hours counter	8	8		
Clock synchronization	-	-		
Synchronization via MPI	-	-		
Synchronization via Ethernet (NTP)	-	-		

SLIO
100V
200V
300S
500S
HMI
Teleservice
StarterKits
Safety
Solutions
Software
Accessories
Appendix

CPUs CPUs STEP7 programmable, PtP					
214-2BS03	215-2BS13				
214-2BS13	215-2BS33				
214-2BS33					
215-2BS03					

Order number	215-2BS13	215-2BS33		
Address areas (I/O)				
Input I/O address area	1024 Byte	1024 Byte		
Output I/O address area	1024 Byte	1024 Byte		
Process image adjustable	-	-		
Input process image preset	128 Byte	128 Byte		
Output process image preset	128 Byte	128 Byte		
Input process image maximal	128 Byte	128 Byte		
Output process image maximal	128 Byte	128 Byte		
Digital inputs	8192	8192		
Digital outputs	8192	8192		
Digital inputs central	512	512		
Digital outputs central	512	512		
Integrated digital inputs	-	-		
Integrated digital outputs	-	-		
Analog inputs	512	512		
Analog outputs	512	512		
Analog inputs, central	128	128		
Analog outputs, central	128	128		
Integrated analog inputs	-	-		
Integrated analog outputs	-	-		
Communication functions				
PG/OP channel	✓	✓		
Global data communication	✓	✓		
Number of GD circuits, max.	4	4		
Size of GD packets, max.	22 Byte	22 Byte		
S7 basic communication	✓	✓		
S7 basic communication, user data per job	76 Byte	76 Byte		
S7 communication	✓	✓		
S7 communication as server	✓	✓		
S7 communication as client	-	-		
S7 communication, user data per job	160 Byte	160 Byte		
Number of connections, max.	16	16		
Functionality Sub-D interfaces				
Type	MP ² I	MP ² I		
Type of interface	RS485	RS485		
Connector	Sub-D, 9-pin, female	Sub-D, 9-pin, female		
Electrically isolated	-	-		
MPI	✓	✓		
MP ² I (MPI/RS232)	✓	✓		
Point-to-point interface	-	-		

CPU CPU STEP7 programmable, PtP					
214-2BS03	215-2BS13				
214-2BS13	215-2BS33				
214-2BS33					
215-2BS03					

Order number	215-2BS13	215-2BS33		
Type	COM	COM		
Type of interface	RS232	RS485		
Connector	Sub-D, 9-pin, male	Sub-D, 9-pin, female		
Electrically isolated	-	✓		
MPI	-	-		
MP ² I (MPI/RS232)	-	-		
Point-to-point interface	✓	✓		
Type	-	-		
Type of interface	-	-		
Connector	-	-		
Electrically isolated	-	-		
MPI	-	-		
MP ² I (MPI/RS232)	-	-		
Point-to-point interface	-	-		
Functionality MPI				
Number of connections, max.	16	16		
PG/OP channel	✓	✓		
Routing	-	-		
Global data communication	✓	✓		
S7 basic communication	✓	✓		
S7 communication	✓	✓		
S7 communication as server	✓	✓		
S7 communication as client	-	-		
Transmission speed, min.	19.2 kbit/s	19.2 kbit/s		
Transmission speed, max.	187.5 kbit/s	187.5 kbit/s		
Point-to-point communication				
PtP communication	✓	✓		
Interface isolated	-	✓		
RS232 interface	✓	-		
RS422 interface	-	-		
RS485 interface	-	✓		
Connector	Sub-D, 9-pin, male	Sub-D, 9-pin, female		
Transmission speed, min.	150 bit/s	150 bit/s		
Transmission speed, max.	115.2 kbit/s	115.2 kbit/s		
Cable length, max.	15 m	500 m		
Point-to-point protocol				
ASCII protocol	✓	✓		
STX/ETX protocol	✓	✓		
3964(R) protocol	✓	✓		
RK512 protocol	-	-		
USS master protocol	✓	✓		
Modbus master protocol	✓	✓		
Modbus slave protocol	✓	✓		
Special protocols	-	-		

CPU CPU STEP7 programmable, PtP					
214-2BS03	215-2BS13				
214-2BS13	215-2BS33				
214-2BS33					
215-2BS03					

Order number	215-2BS13	215-2BS33		
Datasizes				
Input bytes	0	0		
Output bytes	0	0		
Parameter bytes	3	3		
Diagnostic bytes	0	0		
Housing				
Material	PPE / PA 6.6	PPE / PA 6.6		
Mounting	Profile rail 35 mm	Profile rail 35 mm		
Mechanical data				
Dimensions (WxHxD)	50.8 mm x 76 mm x 80 mm	50.8 mm x 76 mm x 80 mm		
Weight	150 g	150 g		
Environmental conditions				
Operating temperature	0 °C to 60 °C	0 °C to 60 °C		
Storage temperature	-25 °C to 70 °C	-25 °C to 70 °C		
Certifications				
UL508 certification	yes	yes		

- SLIO
- 100V
- 200V
- 300S
- 500S
- HMI
- Teleservice
- StarterKits
- Safety
- Solutions
- Software
- Accessories
- Appendix

Connections, Interfaces

CPU | CPUs STEP7 programmable, PtP

214-2BS03 214-2BS13 214-2BS33 215-2BS03	215-2BS13 215-2BS33				
--	------------------------	--	--	--	--

215-2BS13



COM RS232

- ① CD-
- ② RxD
- ③ TxD
- ④ DTR-
- ⑤ GND
- ⑥ DSR-
- ⑦ RTS-
- ⑧ CTS-
- ⑨ RI-

MP²1

- ① reserved
- ② M24V
- ③ RxD/TxD-P (line B)
- ④ RTS
- ⑤ M5V
- ⑥ P5V
- ⑦ P24V
- ⑧ RxD/TxD-N (line A)
- ⑨ n.c.

X1

- + DC 24 V
- 0 V

215-2BS33



COM RS485

- ① n. c.
- ② n. c.
- ③ RxD/TxD-P (line B)
- ④ RTS
- ⑤ M5V
- ⑥ P5V
- ⑦ n. c.
- ⑧ RxD/TxD-N (line A)
- ⑨ n.c.

MP²1



- ① reserved
- ② M24V
- ③ RxD/TxD-P (line B)
- ④ RTS
- ⑤ M5V
- ⑥ P5V
- ⑦ P24V
- ⑧ RxD/TxD-N (line A)
- ⑨ n.c.

X1

- + DC 24 V
- 0 V

CPUs STEP7 programmable, DP master

CPUs CPUs STEP7 programmable, DP master					
214-2BM03					
214-2BM06					
215-2BM03					

Order number	214-2BM03	214-2BM06	215-2BM03	
Figure				
Type	CPU 214DPM	CPU 214DPM	CPU 215DPM	
General information				
Note	-	-	-	
Features	<ul style="list-style-type: none"> › PROFIBUS-DP master › 96 kB work memory › 144 kB load memory 	<ul style="list-style-type: none"> › PROFIBUS-DP master › 96 kB work memory › 144 kB load memory › Also configurable via TIA-Portal 	<ul style="list-style-type: none"> › PROFIBUS-DP master › 128 kB work memory › 192 kB load memory 	
Technical data power supply				
Power supply (rated value)	DC 24 V	DC 24 V	DC 24 V	
Power supply (permitted range)	DC 20.4...28.8 V	DC 20.4...28.8 V	DC 20.4...28.8 V	
Reverse polarity protection	✓	✓	✓	
Current consumption (no-load operation)	130 mA	130 mA	130 mA	
Current consumption (rated value)	1.5 A	1.5 A	1.5 A	
Inrush current	65 A	65 A	65 A	
I²t	0.75 A²s	0.75 A²s	0.75 A²s	
Max. current drain at backplane bus	3 A	3 A	3 A	
Power loss	5 W	5 W	5 W	
Load and working memory				
Load memory, integrated	144 KB	144 KB	192 KB	
Load memory, maximum	144 KB	144 KB	192 KB	
Work memory, integrated	96 KB	96 KB	128 KB	
Work memory, maximal	96 KB	96 KB	128 KB	
Memory divided in 50% program / 50% data	-	-	-	
Memory card slot	MMC-Card with max. 512 MB	MMC-Card with max. 512 MB	MMC-Card with max. 512 MB	
Hardware configuration				
Racks, max.	4	4	4	
Modules per rack, max.	total max. 32	total max. 32	total max. 32	
Number of integrated DP master	1	1	1	
Number of DP master via CP	8	8	8	
Operable function modules	32	32	32	
Operable communication modules PtP	32	32	32	
Operable communication modules LAN	-	-	-	
Command processing times				
Bit instructions, min.	0.18 µs	0.18 µs	0.18 µs	
Word instruction, min.	0.78 µs	0.78 µs	0.78 µs	
Double integer arithmetic, min.	1.8 µs	1.8 µs	1.8 µs	
Floating-point arithmetic, min.	40 µs	40 µs	40 µs	

SLIO
100V
200V
300S
500S
HMI
Teleservice
StarterKits
Safety
Solutions
Software
Accessories
Appendix

CPUs CPUs STEP7 programmable, DP master						
214-2BM03						
214-2BM06						
215-2BM03						

Order number	214-2BM03	214-2BM06	215-2BM03	
Timers/Counters and their retentive characteristics				
Number of S7 counters	256	256	256	
S7 counter remanence	adjustable 0 up to 64	adjustable 0 up to 64	adjustable 0 up to 64	
S7 counter remanence adjustable	C0 .. C7	C0 .. C7	C0 .. C7	
Number of S7 times	256	256	256	
S7 times remanence	adjustable 0 up to 128	adjustable 0 up to 128	adjustable 0 up to 128	
S7 times remanence adjustable	not retentive	not retentive	not retentive	
Data range and retentive characteristic				
Number of flags	8192 Bit	8192 Bit	8192 Bit	
Bit memories retentive characteristic adjustable	adjustable 0 up to 256	adjustable 0 up to 256	adjustable 0 up to 256	
Bit memories retentive characteristic preset	MB0 .. MB15	MB0 .. MB15	MB0 .. MB15	
Number of data blocks	2047	2047	2047	
Max. data blocks size	16 KB	16 KB	16 KB	
Number range DBs	1 ... 2047	1 ... 2047	1 ... 2047	
Max. local data size per execution level	1024 Byte	1024 Byte	1024 Byte	
Max. local data size per block	1024 Byte	1024 Byte	1024 Byte	
Blocks				
Number of OBs	14	14	14	
Maximum OB size	16 KB	16 KB	16 KB	
Totalnumber DBs, FBs, FCs	-	-	-	
Number of FBs	1024	1024	1024	
Maximum FB size	16 KB	16 KB	16 KB	
Number range FBs	0 ... 1023	0 ... 1023	0 ... 1023	
Number of FCs	1024	1024	1024	
Maximum FC size	16 KB	16 KB	16 KB	
Number range FC2	0 ... 1023	0 ... 1023	0 ... 1023	
Maximum nesting depth per priority class	8	8	8	
Maximum nesting depth additional within an error OB	1	1	1	
Time				
Real-time clock buffered	✓	✓	✓	
Clock buffered period (min.)	30 d	30 d	30 d	
Type of buffering	-	-	-	
Load time for 50% buffering period	20 h	20 h	20 h	
Load time for 100% buffering period	48 h	48 h	48 h	
Accuracy (max. deviation per day)	10 s	10 s	10 s	
Number of operating hours counter	8	8	8	
Clock synchronization	-	-	-	
Synchronization via MPI	-	-	-	
Synchronization via Ethernet (NTP)	-	-	-	

CPU CPU STEP7 programmable, DP master						
214-2BM03						
214-2BM06						
215-2BM03						

Order number	214-2BM03	214-2BM06	215-2BM03	
Address areas (I/O)				
Input I/O address area	1024 Byte	1024 Byte	1024 Byte	
Output I/O address area	1024 Byte	1024 Byte	1024 Byte	
Process image adjustable	-	-	-	
Input process image preset	128 Byte	128 Byte	128 Byte	
Output process image preset	128 Byte	128 Byte	128 Byte	
Input process image maximal	128 Byte	128 Byte	128 Byte	
Output process image maximal	128 Byte	128 Byte	128 Byte	
Digital inputs	8192	8192	8192	
Digital outputs	8192	8192	8192	
Digital inputs central	512	512	512	
Digital outputs central	512	512	512	
Integrated digital inputs	-	-	-	
Integrated digital outputs	-	-	-	
Analog inputs	512	512	512	
Analog outputs	512	512	512	
Analog inputs, central	128	128	128	
Analog outputs, central	128	128	128	
Integrated analog inputs	-	-	-	
Integrated analog outputs	-	-	-	
Communication functions				
PG/OP channel	✓	✓	✓	
Global data communication	✓	✓	✓	
Number of GD circuits, max.	4	4	4	
Size of GD packets, max.	22 Byte	22 Byte	22 Byte	
S7 basic communication	✓	✓	✓	
S7 basic communication, user data per job	76 Byte	76 Byte	76 Byte	
S7 communication	✓	✓	✓	
S7 communication as server	✓	✓	✓	
S7 communication as client	-	-	-	
S7 communication, user data per job	160 Byte	160 Byte	160 Byte	
Number of connections, max.	16	16	16	
Functionality Sub-D interfaces				
Type	MP ² I	MP ² I	MP ² I	
Type of interface	RS485	RS485	RS485	
Connector	Sub-D, 9-pin, female	Sub-D, 9-pin, female	Sub-D, 9-pin, female	
Electrically isolated	-	-	-	
MPI	✓	✓	✓	
MP ² I (MPI/RS232)	✓	✓	✓	
DP master	-	-	-	
DP slave	-	-	-	
Point-to-point interface	-	-	-	

SLIO
100V
200V
300S
500S
HMI
Teleservice
StarterKits
Safety
Solutions
Software
Accessories
Appendix

CPUs CPUs STEP7 programmable, DP master						
214-2BM03						
214-2BM06						
215-2BM03						

Order number	214-2BM03	214-2BM06	215-2BM03	
Type	DP	DP	DP	
Type of interface	RS485	RS485	RS485	
Connector	Sub-D, 9-pin, female	Sub-D, 9-pin, female	Sub-D, 9-pin, female	
Electrically isolated	✓	✓	✓	
MPI	-	-	-	
MP ² I (MPI/RS232)	-	-	-	
DP master	yes	yes	yes	
DP slave	-	-	-	
Point-to-point interface	-	-	-	
Functionality MPI				
Number of connections, max.	16	16	16	
PG/OP channel	✓	✓	✓	
Routing	-	-	-	
Global data communication	✓	✓	✓	
S7 basic communication	✓	✓	✓	
S7 communication	✓	✓	✓	
S7 communication as server	✓	✓	✓	
S7 communication as client	-	-	-	
Transmission speed, min.	19.2 kbit/s	19.2 kbit/s	19.2 kbit/s	
Transmission speed, max.	187.5 kbit/s	187.5 kbit/s	187.5 kbit/s	
Functionality PROFIBUS master				
PG/OP channel	✓	✓	✓	
Routing	-	-	-	
S7 basic communication	-	-	-	
S7 communication	-	-	-	
S7 communication as server	-	-	-	
S7 communication as client	-	-	-	
Activation/deactivation of DP slaves	✓	✓	✓	
Direct data exchange (slave-to-slave communication)	-	-	-	
DPV1	-	-	-	
Transmission speed, min.	9.6 kbit/s	9.6 kbit/s	9.6 kbit/s	
Transmission speed, max.	12 Mbit/s	12 Mbit/s	12 Mbit/s	
Number of DP slaves, max.	64	64	64	
Address range inputs, max.	1 KB	1 KB	1 KB	
Address range outputs, max.	1 KB	1 KB	1 KB	
User data inputs per slave, max.	244 Byte	244 Byte	244 Byte	
User data outputs per slave, max.	244 Byte	244 Byte	244 Byte	

CPU CPU STEP7 programmable, DP master						
214-2BM03						
214-2BM06						
215-2BM03						

Order number	214-2BM03	214-2BM06	215-2BM03	
Datasizes				
Input bytes	0	0	0	
Output bytes	0	0	0	
Parameter bytes	4	4	4	
Diagnostic bytes	0	0	0	
Housing				
Material	PPE / PA 6.6	PPE / PA 6.6	PPE / PA 6.6	
Mounting	Profile rail 35 mm	Profile rail 35 mm	Profile rail 35 mm	
Mechanical data				
Dimensions (WxHxD)	50.8 mm x 76 mm x 80 mm	50.8 mm x 76 mm x 80 mm	50.8 mm x 76 mm x 80 mm	
Weight	150 g	150 g	150 g	
Environmental conditions				
Operating temperature	0 °C to 60 °C	0 °C to 60 °C	0 °C to 60 °C	
Storage temperature	-25 °C to 70 °C	-25 °C to 70 °C	-25 °C to 70 °C	
Certifications				
UL508 certification	yes	in preparation	yes	

Connections, Interfaces

CPU | CPUs STEP7 programmable, DP master

214-2BM03
214-2BM06
215-2BM03

214-2BM03

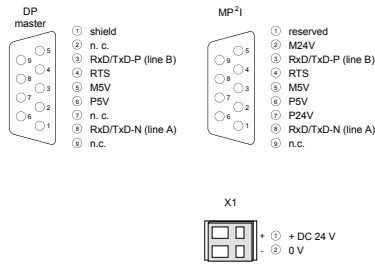

214-2BM06

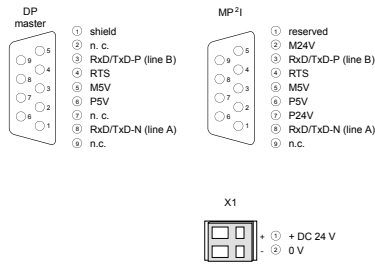

215-2BM03

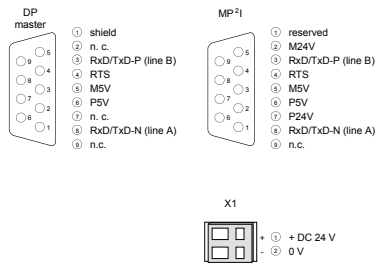

CPUs STEP7 programmable, DP slave

CPUs CPUs STEP7 programmable, DP slave					
214-2BP03					
215-2BP03					

Order number	214-2BP03	215-2BP03		
Figure				
Type	CPU 214DP	CPU 215DP		
General information				
Note	-	-		
Features	<ul style="list-style-type: none"> ▸ PROFIBUS-DP slave ▸ 96 kB work memory ▸ 144 kB load memory 	<ul style="list-style-type: none"> ▸ PROFIBUS-DP slave ▸ 128 kB work memory ▸ 192 kB load memory 		
Technical data power supply				
Power supply (rated value)	DC 24 V	DC 24 V		
Power supply (permitted range)	DC 20.4...28.8 V	DC 20.4...28.8 V		
Reverse polarity protection	✓	✓		
Current consumption (no-load operation)	100 mA	100 mA		
Current consumption (rated value)	1.5 A	1.5 A		
Inrush current	65 A	65 A		
I²t	0.75 A²s	0.75 A²s		
Max. current drain at backplane bus	3 A	3 A		
Power loss	5 W	5 W		
Load and working memory				
Load memory, integrated	144 KB	192 KB		
Load memory, maximum	144 KB	192 KB		
Work memory, integrated	96 KB	128 KB		
Work memory, maximal	96 KB	128 KB		
Memory divided in 50% program / 50% data	-	-		
Memory card slot	MMC-Card with max. 512 MB	MMC-Card with max. 512 MB		
Hardware configuration				
Racks, max.	4	4		
Modules per rack, max.	total max. 32	total max. 32		
Number of integrated DP master	-	-		
Number of DP master via CP	8	8		
Operable function modules	32	32		
Operable communication modules PtP	32	32		
Operable communication modules LAN	-	-		
Command processing times				
Bit instructions, min.	0.18 µs	0.18 µs		
Word instruction, min.	0.78 µs	0.78 µs		
Double integer arithmetic, min.	1.8 µs	1.8 µs		
Floating-point arithmetic, min.	40 µs	40 µs		

CPU CPUs STEP7 programmable, DP slave					
214-2BP03					
215-2BP03					

Order number	214-2BP03	215-2BP03		
Timers/Counters and their retentive characteristics				
Number of S7 counters	256	256		
S7 counter remanence	adjustable 0 up to 64	adjustable 0 up to 64		
S7 counter remanence adjustable	C0 .. C7	8		
Number of S7 times	256	256		
S7 times remanence	adjustable 0 up to 128	adjustable 0 up to 128		
S7 times remanence adjustable	not retentive	not retentive		
Data range and retentive characteristic				
Number of flags	8192 Bit	8192 Bit		
Bit memories retentive characteristic adjustable	adjustable 0 up to 256	adjustable 0 up to 256		
Bit memories retentive characteristic preset	MB0 .. MB15	MB0 .. MB15		
Number of data blocks	2047	2047		
Max. data blocks size	16 KB	16 KB		
Number range DBs	1 ... 2047	1 ... 2047		
Max. local data size per execution level	1024 Byte	1024 Byte		
Max. local data size per block	1024 Byte	1024 Byte		
Blocks				
Number of OBs	14	14		
Maximum OB size	16 KB	16 KB		
Totalnumber DBs, FBs, FCs	-	-		
Number of FBs	1024	1024		
Maximum FB size	16 KB	16 KB		
Number range FBs	0 ... 1023	0 ... 1023		
Number of FCs	1024	1024		
Maximum FC size	16 KB	16 KB		
Number range FC2	0 ... 1023	0 ... 1023		
Maximum nesting depth per priority class	8	8		
Maximum nesting depth additional within an error OB	1	1		
Time				
Real-time clock buffered	✓	✓		
Clock buffered period (min.)	30 d	30 d		
Type of buffering	-	-		
Load time for 50% buffering period	20 h	20 h		
Load time for 100% buffering period	48 h	48 h		
Accuracy (max. deviation per day)	10 s	10 s		
Number of operating hours counter	8	8		
Clock synchronization	-	-		
Synchronization via MPI	-	-		
Synchronization via Ethernet (NTP)	-	-		
Address areas (I/O)				
Input I/O address area	1024 Byte	1024 Byte		
Output I/O address area	1024 Byte	1024 Byte		
Process image adjustable	-	-		
Input process image preset	128 Byte	128 Byte		

SLIO
100V
200V
300S
500S
HMI
Teleservice
StarterKits
Safety
Solutions
Software
Accessories
Appendix
284

CPU CPU STEP7 programmable, DP slave					
214-2BP03					
215-2BP03					

Order number	214-2BP03	215-2BP03		
Output process image preset	128 Byte	128 Byte		
Input process image maximal	128 Byte	128 Byte		
Output process image maximal	128 Byte	128 Byte		
Digital inputs	8192	8192		
Digital outputs	8192	8192		
Digital inputs central	512	512		
Digital outputs central	512	512		
Integrated digital inputs	-	-		
Integrated digital outputs	-	-		
Analog inputs	512	512		
Analog outputs	512	512		
Analog inputs, central	128	128		
Analog outputs, central	128	128		
Integrated analog inputs	-	-		
Integrated analog outputs	-	-		
Communication functions				
PG/OP channel	✓	✓		
Global data communication	✓	✓		
Number of GD circuits, max.	4	4		
Size of GD packets, max.	22 Byte	22 Byte		
S7 basic communication	✓	✓		
S7 basic communication, user data per job	76 Byte	76 Byte		
S7 communication	✓	✓		
S7 communication as server	✓	✓		
S7 communication as client	-	-		
S7 communication, user data per job	160 Byte	160 Byte		
Number of connections, max.	16	16		
Functionality Sub-D interfaces				
Type	MP ² I	MP ² I		
Type of interface	RS485	RS485		
Connector	Sub-D, 9-pin, female	Sub-D, 9-pin, female		
Electrically isolated	-	-		
MPI	✓	✓		
MP ² I (MPI/RS232)	✓	✓		
DP master	-	-		
DP slave	-	-		
Point-to-point interface	-	-		
Functionality DP interfaces				
Type	DP	DP		
Type of interface	RS485	RS485		
Connector	Sub-D, 9-pin, female	Sub-D, 9-pin, female		
Electrically isolated	✓	✓		
MPI	-	-		
MP ² I (MPI/RS232)	-	-		
DP master	-	-		
DP slave	yes	yes		
Point-to-point interface	-	-		

CPU CPUs STEP7 programmable, DP slave					
214-2BP03					
215-2BP03					

Order number	214-2BP03	215-2BP03		
Functionality MPI				
Number of connections, max.	16	16		
PG/OP channel	✓	✓		
Routing	-	-		
Global data communication	✓	✓		
S7 basic communication	✓	✓		
S7 communication	✓	✓		
S7 communication as server	✓	✓		
S7 communication as client	-	-		
Transmission speed, min.	19.2 kbit/s	19.2 kbit/s		
Transmission speed, max.	187.5 kbit/s	187.5 kbit/s		
Functionality PROFIBUS slave				
PG/OP channel	-	-		
Routing	-	-		
S7 communication	-	-		
S7 communication as server	-	-		
S7 communication as client	-	-		
Direct data exchange (slave-to-slave communication)	-	-		
DPV1	-	-		
Transmission speed, min.	9.6 kbit/s	9.6 kbit/s		
Transmission speed, max.	12 Mbit/s	12 Mbit/s		
Automatic detection of transmission speed	-	-		
Transfer memory inputs, max.	64 Byte	64 Byte		
Transfer memory outputs, max.	64 Byte	64 Byte		
Address areas, max.	1	1		
User data per address area, max.	64 Byte	64 Byte		
Datasizes				
Input bytes	0	0		
Output bytes	0	0		
Parameter bytes	16	16		
Diagnostic bytes	0	0		
Housing				
Material	PPE / PA 6.6	PPE / PA 6.6		
Mounting	Profile rail 35 mm	Profile rail 35 mm		
Mechanical data				
Dimensions (WxHxD)	50.8 mm x 76 mm x 80 mm	50.8 mm x 76 mm x 80 mm		
Weight	150 g	150 g		
Environmental conditions				
Operating temperature	0 °C to 60 °C	0 °C to 60 °C		
Storage temperature	-25 °C to 70 °C	-25 °C to 70 °C		
Certifications				
UL508 certification	yes	yes		

SLIO
100V
200V
300S
500S
HMI
Teleservice
StarterKits
Safety
Solutions
Software
Accessories
Appendix

Connections, Interfaces

CPUs | CPUs STEP7 programmable, DP slave

214-2BP03
215-2BP03

214-2BP03

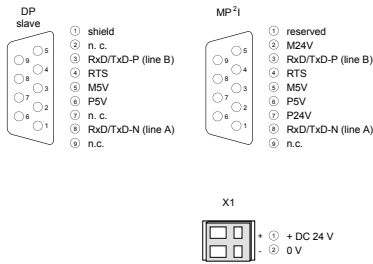

215-2BP03

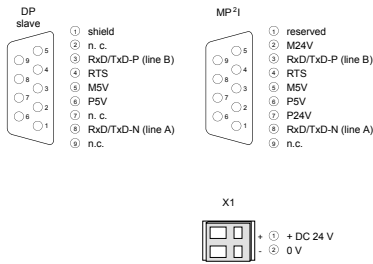

CPUs STEP7 programmable, CAN master

CPUs CPUs STEP7 programmable, CAN master					
214-2CM03					
215-2CM03					

Order number	214-2CM03	215-2CM03		
Figure				
Type	CPU 214CAN	CPU 215CAN		
General information				
Note	-	-		
Features	<ul style="list-style-type: none"> ▸ CANopen master ▸ 96 kB work memory ▸ 144 kB load memory 	<ul style="list-style-type: none"> ▸ CANopen master ▸ 128 kB work memory ▸ 192 kB load memory 		
Technical data power supply				
Power supply (rated value)	DC 24 V	DC 24 V		
Power supply (permitted range)	DC 20.4...28.8 V	DC 20.4...28.8 V		
Reverse polarity protection	✓	✓		
Current consumption (no-load operation)	110 mA	110 mA		
Current consumption (rated value)	1.5 A	1.5 A		
Inrush current	65 A	65 A		
I ² t	0.75 A ² s	0.75 A ² s		
Max. current drain at backplane bus	3 A	3 A		
Power loss	5 W	5 W		
Load and working memory				
Load memory, integrated	144 KB	192 KB		
Load memory, maximum	144 KB	192 KB		
Work memory, integrated	96 KB	128 KB		
Work memory, maximal	96 KB	128 KB		
Memory divided in 50% program / 50% data	-	-		
Memory card slot	MMC-Card with max. 512 MB	MMC-Card with max. 512 MB		
Hardware configuration				
Racks, max.	4	4		
Modules per rack, max.	total max. 32	total max. 32		
Number of integrated DP master	-	-		
Number of DP master via CP	8	8		
Operable function modules	32	32		
Operable communication modules PtP	32	32		
Operable communication modules LAN	-	-		
Command processing times				
Bit instructions, min.	0.18 µs	0.18 µs		
Word instruction, min.	0.78 µs	0.78 µs		
Double integer arithmetic, min.	1.8 µs	1.8 µs		
Floating-point arithmetic, min.	40 µs	40 µs		

SLIO
100V
200V
300S
500S
HMI
Teleservice
StarterKits
Safety
Solutions
Software
Accessories
Appendix

CPUs CPUs STEP7 programmable, CAN master						
214-2CM03 215-2CM03						

Order number	214-2CM03	215-2CM03		
Timers/Counters and their retentive characteristics				
Number of S7 counters	256	256		
S7 counter remanence	adjustable 0 up to 64	adjustable 0 up to 64		
S7 counter remanence adjustable	C0 .. C7	C0 .. C7		
Number of S7 times	256	256		
S7 times remanence	adjustable 0 up to 128	adjustable 0 up to 128		
S7 times remanence adjustable	not retentive	not retentive		
Data range and retentive characteristic				
Number of flags	8192 Bit	8192 Bit		
Bit memories retentive characteristic adjustable	adjustable 0 up to 256	adjustable 0 up to 256		
Bit memories retentive characteristic preset	MB0 .. MB15	MB0 .. MB15		
Number of data blocks	2047	2047		
Max. data blocks size	16 KB	16 KB		
Number range DBs	1 ... 2047	1 ... 2047		
Max. local data size per execution level	1024 Byte	1024 Byte		
Max. local data size per block	1024 Byte	1024 Byte		
Blocks				
Number of OBs	14	14		
Maximum OB size	16 KB	16 KB		
Totalnumber DBs, FBs, FCs	-	-		
Number of FBs	1024	1024		
Maximum FB size	16 KB	16 KB		
Number range FBs	0 ... 1023	0 ... 1023		
Number of FCs	1024	1024		
Maximum FC size	16 KB	16 KB		
Number range FC2	0 ... 1023	0 ... 1023		
Maximum nesting depth per priority class	8	8		
Maximum nesting depth additional within an error OB	1	1		
Time				
Real-time clock buffered	✓	✓		
Clock buffered period (min.)	30 d	30 d		
Type of buffering	-	-		
Load time for 50% buffering period	20 h	20 h		
Load time for 100% buffering period	48 h	48 h		
Accuracy (max. deviation per day)	10 s	10 s		
Number of operating hours counter	8	8		
Clock synchronization	-	-		
Synchronization via MPI	-	-		
Synchronization via Ethernet (NTP)	-	-		

CPUs CPUs STEP7 programmable, CAN master					
214-2CM03					
215-2CM03					

Order number	214-2CM03	215-2CM03		
Address areas (I/O)				
Input I/O address area	1024 Byte	1024 Byte		
Output I/O address area	1024 Byte	1024 Byte		
Process image adjustable	-	-		
Input process image preset	128 Byte	128 Byte		
Output process image preset	128 Byte	128 Byte		
Input process image maximal	128 Byte	128 Byte		
Output process image maximal	128 Byte	128 Byte		
Digital inputs	8192	8192		
Digital outputs	8192	8192		
Digital inputs central	512	512		
Digital outputs central	512	512		
Integrated digital inputs	-	-		
Integrated digital outputs	-	-		
Analog inputs	512	512		
Analog outputs	512	512		
Analog inputs, central	128	128		
Analog outputs, central	128	128		
Integrated analog inputs	-	-		
Integrated analog outputs	-	-		
Communication functions				
PG/OP channel	✓	✓		
Global data communication	✓	✓		
Number of GD circuits, max.	4	4		
Size of GD packets, max.	22 Byte	22 Byte		
S7 basic communication	✓	✓		
S7 basic communication, user data per job	76 Byte	76 Byte		
S7 communication	✓	✓		
S7 communication as server	✓	✓		
S7 communication as client	-	-		
S7 communication, user data per job	160 Byte	160 Byte		
Number of connections, max.	16	16		
Functionality Sub-D interfaces				
Type	MP ² I	MP ² I		
Type of interface	RS485	RS485		
Connector	Sub-D, 9-pin, female	Sub-D, 9-pin, female		
Electrically isolated	-	-		
MPI	✓	✓		
MP ² I (MPI/RS232)	✓	✓		
DP master	-	-		
DP slave	-	-		
Point-to-point interface	-	-		

CPUs CPUs STEP7 programmable, CAN master					
214-2CM03					
215-2CM03					

Order number	214-2CM03	215-2CM03		
Type	CAN	CAN		
Type of interface	CAN	CAN		
Connector	Sub-D, 9-pin, male	Sub-D, 9-pin, male		
Electrically isolated	✓	✓		
MPI	-	-		
MP ² I (MPI/RS232)	-	-		
DP master	-	-		
DP slave	-	-		
Point-to-point interface	-	-		
Functionality MPI				
Number of connections, max.	16	16		
PG/OP channel	✓	✓		
Routing	-	-		
Global data communication	✓	✓		
S7 basic communication	✓	✓		
S7 communication	✓	✓		
S7 communication as server	✓	✓		
S7 communication as client	-	-		
Transmission speed, min.	19.2 kbit/s	19.2 kbit/s		
Transmission speed, max.	187.5 kbit/s	187.5 kbit/s		
Datasizes				
Input bytes	0	0		
Output bytes	0	0		
Parameter bytes	3	3		
Diagnostic bytes	0	0		
Housing				
Material	PPE / PA 6.6	PPE / PA 6.6		
Mounting	Profile rail 35 mm	Profile rail 35 mm		
Mechanical data				
Dimensions (WxHxD)	50.8 mm x 76 mm x 80 mm	50.8 mm x 76 mm x 80 mm		
Weight	150 g	150 g		
Environmental conditions				
Operating temperature	0 °C to 60 °C	0 °C to 60 °C		
Storage temperature	-25 °C to 70 °C	-25 °C to 70 °C		
Certifications				
UL508 certification	yes	yes		

SLIO
100V
200V
300S
500S
HMI
Teleservice
StarterKits
Safety
Solutions
Software
Accessories
Appendix

Connections, Interfaces

CPU | CPUs STEP7 programmable, CAN master

214-2CM03
215-2CM03

214-2CM03

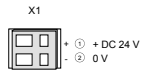
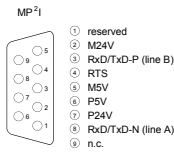
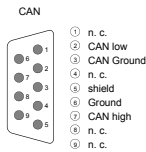

215-2CM03

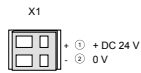
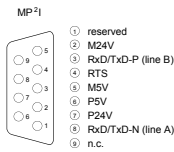
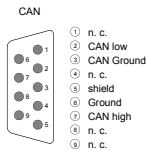

Clamp modules



Structure and Function

Clamp modules are passive modules for 2- or 3-wire installations, the contacts are electrically connected internally vertically. They offer various connectivity options for signals, mass and plus potentials.

By the use of clamp modules distributors for a power supply can be realized in a simple way and thus offer the possibility for connection of active supplied sensors such as proximity switches. Wiring is carried out by means of time saving and secure cage clamp technology.

Passive terminal modules have no connection to the backplane bus. Therefore during the assembly of the terminal modules the signal passage to post-positioned assemblies via backplane bus connectors must be ensured. The terminal modules are attached to the mounting surface using a 35 mm profile rail.

Characteristics

- › Maintenance-free cage clamp technology
- › Color-coded terminals
- › Maximum terminal current 10 A
- › Compact design
- › Assembly with 35 mm profile rail
- › 24 months warranty

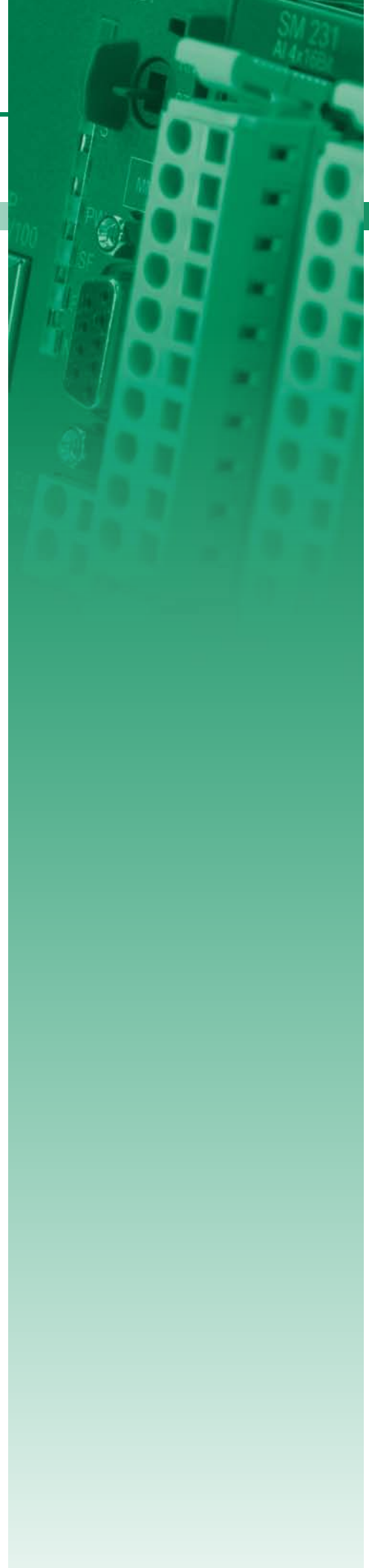



Overview

Order no.	Name/Description	Page
Clamp modules		
201-1AA00	CM 201 - Double clamps module › Dual terminals › 2x11 clamps, gray/gray › Passive	296
201-1AA10	CM 201 - Double clamps module › Dual terminals › 2x11 clamps, green-yellow/gray › Passive	296
201-1AA20	CM 201 - Double clamps module › Dual terminals › 2x11 clamps, red/blue › Passive	296
201-1AA40	CM 201 - 4-tier clamps module › Quad terminals › 2x5 clamps gray/gray › 2x6 clamps red/blue › Passive	296

Clamp modules

Clamp modules Clamp modules						
201-1AA00						
201-1AA10						
201-1AA20						
201-1AA40						

Order number	201-1AA00	201-1AA10	201-1AA20	201-1AA40
Figure				
Type	CM 201	CM 201	CM 201	CM 201
General information				
Note	-	-	-	-
Features	<ul style="list-style-type: none"> ▸ Dual terminals ▸ 2x11 clamps, gray/gray ▸ Passive 	<ul style="list-style-type: none"> ▸ Dual terminals ▸ 2x11 clamps, green-yellow/gray ▸ Passive 	<ul style="list-style-type: none"> ▸ Dual terminals ▸ 2x11 clamps, red/blue ▸ Passive 	<ul style="list-style-type: none"> ▸ Quad terminals ▸ 2x5 clamps gray/gray ▸ 2x6 clamps red/blue ▸ Passive
Clamp parameter				
Terminal voltage max.	DC 60 V	DC 60 V	DC 60 V	DC 60 V
Terminal current max.	10 A	10 A	10 A	10 A
Isolated group				
Number of clamps	11-11	11-11	11-11	5-5-6-6
Color of clamps	grey-grey	green/yellow-grey	red-blue	grey-grey-red-blue
Binding of potential	unbound-unbound	unbound-unbound	unbound-unbound	unbound-unbound-unbound-unbound
Potential group current, max.	10 A-10 A	10 A-10 A	10 A-10 A	10 A-10 A-10 A-10 A
Housing				
Material	PPE / PA 6.6	PPE / PA 6.6	PPE / PA 6.6	PPE / PA 6.6
Mounting	Profile rail 35 mm	Profile rail 35 mm	Profile rail 35 mm	Profile rail 35 mm
Mechanical data				
Dimensions (WxHxD)	25.4 mm x 76 mm x 80 mm	25.4 mm x 76 mm x 80 mm	25.4 mm x 76 mm x 80 mm	25.4 mm x 76 mm x 80 mm
Weight	90 g	90 g	90 g	90 g
Environmental conditions				
Operating temperature	0 °C to 60 °C	0 °C to 60 °C	0 °C to 60 °C	0 °C to 60 °C
Storage temperature	-25 °C to 70 °C	-25 °C to 70 °C	-25 °C to 70 °C	-25 °C to 70 °C
Certifications				
UL508 certification	yes	yes	yes	yes

Connections, Interfaces

Clamp modules | Clamp modules

201-1AA00
201-1AA10
201-1AA20
201-1AA40

201-1AA00

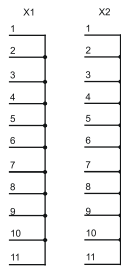

201-1AA10

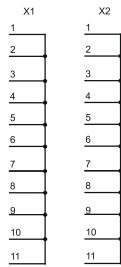

201-1AA20

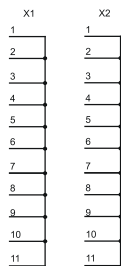

201-1AA40

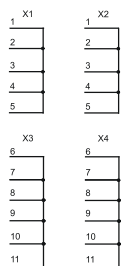

Power supply



Structure and Function

Power supply modules are used to supply the system as well as the sensors and actuators with direct current. They convert the mains AC voltage into a DC voltage of 24 V.

Power supply modules can be fixed on a 35 mm profile rail either combined with system 200V components or as "stand-alone" modules.

The power supply has no connection to the backplane bus.

Characteristics

- › Automatic wide range input detection (AC 100 V - 240 V)
- › Connection to single phase AC mains
- › Output current 2 A
- › Nominal output voltage DC 24 V
- › Front integrated status LEDs for fault diagnosis
- › Protection against short circuit, overload and open circuit
- › IP 20 protection
- › Compact design
- › Assembly with 35 mm profile rail
- › 24 month warranty

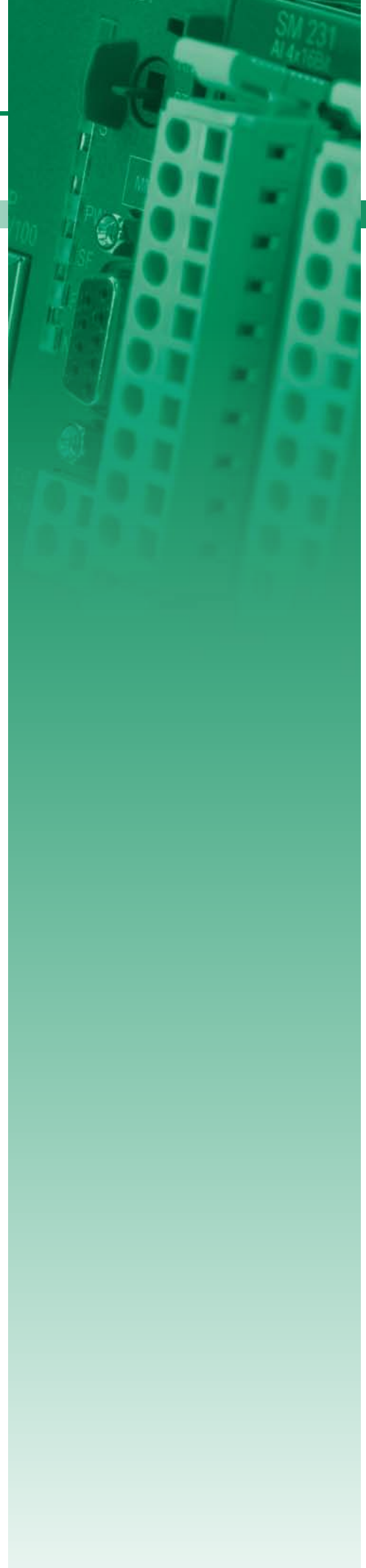



Overview

Order no.	Name/Description	Page
Power supply		
207-1BA00	PS 207 - Power supply ‣ AC 100...240 V w/o manual intervention ‣ Output voltage DC 24 V	300
207-2BA20	PS 207 - Power supply ‣ AC 100...240 V w/o manual intervention ‣ Output voltage DC 24 V ‣ Terminal module with 2x11 clamps	300

Power supply

Power supply | Power supply

207-1BA00
207-2BA20

Order number	207-1BA00	207-2BA20		
Figure				
Type	PS 207	PS 207		
General information				
Note	-	-		
Features	<ul style="list-style-type: none"> ▸ AC 100...240 V w/o manual intervention ▸ Output voltage DC 24 V 	<ul style="list-style-type: none"> ▸ AC 100...240 V w/o manual intervention ▸ Output voltage DC 24 V ▸ Terminal module with 2x11 clamps 		
Technical data power supply				
Input voltage (rated value)	AC 100...240 V	AC 100...240 V		
Input voltage (permitted range)	AC 100...240 V	AC 100...240 V		
Mains frequency (rated value)	50...60 Hz	50...60 Hz		
Mains frequency (permitted range)	47...63 Hz	47...63 Hz		
Input current (at 120 V)	0.53 A	0.53 A		
Input current (at 230 V)	0.24 A	0.24 A		
Inrush current (at 25 °C)	30 A	30 A		
Power consumption typ.	53 W	53 W		
Output voltage (rated value)	24 V	24 V		
Output current (rated value)	2 A	2 A		
Power supply parallel switchable	✓	✓		
Protect type	Short circuit, overload, over temperature	Short circuit, overload, over temperature		
Ripple of output voltage (max.), BW=20 MHz	100 mV	100 mV		
Efficiency typ.	90 %	90 %		
Power loss typ.	5 W	5 W		
Clamp parameter				
Terminal voltage max.	-	DC 60 V		
Terminal current max.	-	10 A		
Status information, alarms, diagnostics				
Status display	yes	yes		
Interrupts	no	no		
Process alarm	no	no		
Diagnostic interrupt	no	no		
Diagnostic functions	no	no		
Diagnostics information read-out	none	none		
Supply voltage display	none	none		
Group error display	none	none		
Channel error display	none	none		

Power supply Power supply						
207-1BA00 207-2BA20						

Order number	207-1BA00	207-2BA20		
Housing				
Material	PPE / PA 6.6	PPE / PA 6.6		
Mounting	Profile rail 35 mm	Profile rail 35 mm		
Mechanical data				
Dimensions (WxHxD)	25.4 mm x 76 mm x 78 mm	50.8 mm x 76 mm x 78 mm		
Weight	150 g	210 g		
Environmental conditions				
Operating temperature	0 °C to 60 °C	0 °C to 60 °C		
Storage temperature	-25 °C to 70 °C	-25 °C to 70 °C		
Certifications				
UL508 certification	-	-		

Connections, Interfaces

Power supply | Power supply

207-1BA00
207-2BA20

207-1BA00

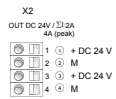
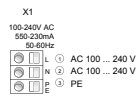

207-2BA20

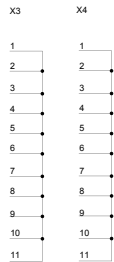
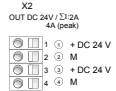
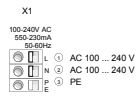

Signal modules digital



Structure and Function

Digital modules for connection of sensors and actuators are the interface of the PLC to the process. Digital input modules acquire the binary control signals from the process level and transform them into interpretable signals for the control. Digital output modules convert the internal binary control signals into signals suitable for the process level. There are digital modules with 4 to 32 channels available.

Characteristics

- › Large selection, modules are available for all popular applications
- › Compact design
- › LED status indicator
- › Electrically isolated to the backplane bus
- › Maintenance-free cage-clamp technology
- › Label cards included
- › Front connector included
- › Assembly with 35 mm profile rail
- › 24 month warranty

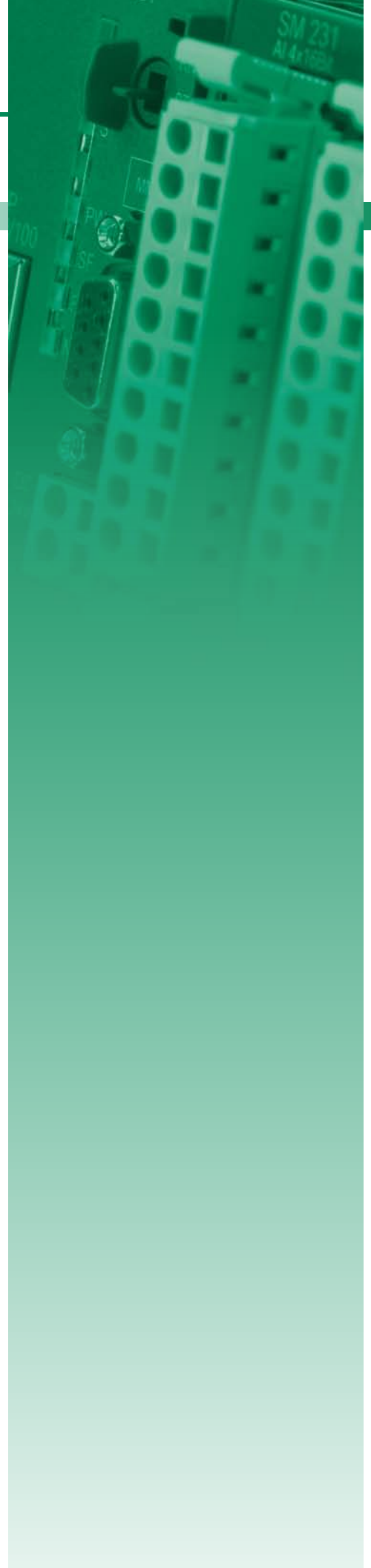

Overview

Order no.	Name/Description	Page
Digital input modules		
221-1BF00	SM 221 - Digital input ‣ 8 inputs	307
221-1BF10	SM 221 - Digital input ‣ 8 inputs, ‣ Delay time 0.2 ms	307
221-1BF21	SM 221 - Digital input ‣ 8 alarm inputs ‣ Delay time 0.2 ms	307
221-1BF30	SM 221 - Digital input ECO ‣ 8 inputs	307
221-1BF50	SM 221 - Digital input ‣ 8 inputs ‣ Active low input	310
221-1BH00	SM 221 - Digital input ‣ 16 inputs ‣ LED status display on the conversion module UB4x	310
221-1BH10	SM 221 - Digital input ‣ 16 inputs	310
221-1BH30	SM 221 - Digital input ECO ‣ 16 inputs	310
221-1BH50	SM 221 - Digital input ‣ 16 inputs ‣ Active low input ‣ LED status display on conversion module UB4x	313
221-1BH51	SM 221 - Digital input ‣ 16 inputs ‣ Active low input	313
221-1FD00	SM 221 - Digital input ‣ 4 inputs ‣ AC/DC 90...230 V ‣ Isolation per channel	313
221-1FF20	SM 221 - Digital input ‣ 8 inputs ‣ AC/DC 60...230 V	313
221-1FF30	SM 221 - Digital input ‣ 8 inputs ‣ AC/DC 24...48 V	316
221-1FF50	SM 221 - Digital input ‣ 8 inputs ‣ AC 180...265 V	316
221-2BL10	SM 221 - Digital input ‣ 32 inputs	316
KSD221-1BH00	SM 221 Set - Digital input ‣ 16 inputs ‣ LED status display on conversion module UB48D	316
KS221-1BH00	SM 221 Set - Digital input ‣ 16 inputs ‣ LED status display on conversion module UB48	319
Digital input with counter		
221-1BH20	SM 221 - Digital input ‣ 16 inputs ‣ 2 inputs are configurable as counter ‣ LED status display	322
Digital output modules		
222-1BF00	SM 222 - Digital output ‣ 8 outputs ‣ Output current 1 A	325
222-1BF10	SM 222 - Digital output ‣ 8 outputs ‣ Output current 2 A	325
222-1BF20	SM 222 - Digital output ‣ 8 outputs ‣ Isolation in 4 groups per 2 outputs ‣ Output current 2 A	325
222-1BF30	SM 222 - Digital output ECO ‣ 8 outputs ‣ Output current 0.5 A	325



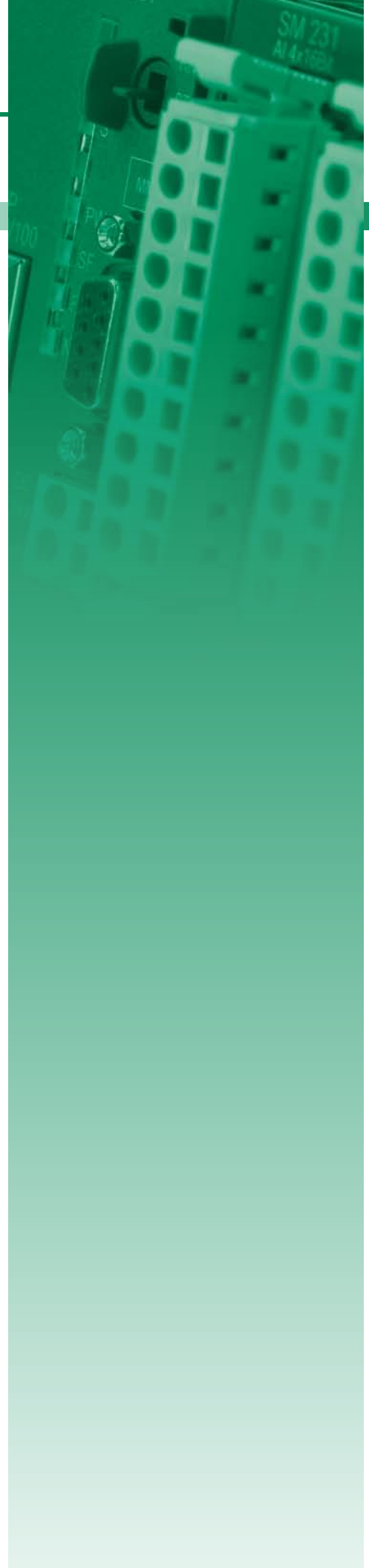

Overview

Order no.	Name/Description	Page
222-1BF50	SM 222 - Digital output ▶ 8 Low-Side outputs ▶ Output current 0.5 A	328
222-1BH00	SM 222 - Digital output ▶ 16 outputs ▶ Output current 0.5 A ▶ LED status display on conversion module UB4x	328
222-1BH10	SM 222 - Digital output ▶ 16 outputs ▶ Output current 1 A	328
222-1BH20	SM 222 - Digital output ▶ 16 outputs ▶ Output current 2 A	328
222-1BH30	SM 222 - Digital output ECO ▶ 16 outputs ▶ Output current 0.5 A	331
222-1BH50	SM 222 - Digital output ▶ 16 Low-Side outputs ▶ Output current 0.5 A	331
222-1BH51	SM 222 - Digital output ▶ 16 Low-Side outputs ▶ Output current 0.5A	331
222-1DB00	SM 222 - Digital output ▶ 2 outputs ▶ AC 100...240 V ▶ Output current 2 A ▶ Software dimmer for resistive, inductive or capacitive load ▶ Frequency range 47...63 Hz	331
222-1FF00	SM 222 - Digital output ▶ 8 solid-state outputs ▶ AC 230 V/ DC 400 V ▶ Output current 0.5 A	334
222-1HD10	SM 222 - Digital output ▶ 4 isolated relay outputs ▶ AC 230 V/ DC 30 V ▶ Output current 5 A	334
222-1HD20	SM 222 - Digital output ▶ 4 isolated relay outputs ▶ AC 230 V/ DC 30 V ▶ Output current 16 A	334
222-1HF00	SM 222 - Digital output ▶ 8 relay outputs ▶ AC 230 V/ DC 30 V ▶ Output current 5 A	334
222-2BL10	SM 222 - Digital output ▶ 32 outputs ▶ Output current 1 A	337
KSD222-1BH00	SM 222 Set - Digital output ▶ 16 outputs ▶ LED status display on conversion module UB48D ▶ Output current 0.5 A	337
KS222-1BH00	SM 222 Set - Digital output ▶ 16 outputs ▶ LED status display on conversion module UB48 ▶ Output current 0.5 A	337
Digital in/output modules		
223-1BF00	SM 223 - Digital in-/output ▶ 8 channels (as input or output) ▶ Output current 1 A ▶ Diagnostics function	340
223-2BL10	SM 223 - Digital in-/output ▶ 16 inputs/ 16 outputs ▶ DC 24 V ▶ Output current 1 A	340



Digital input modules

Signal modules digital Digital input modules					
221-1BF00	221-1BF50	221-1BH50	221-1FF30	KS221-1BH00	
221-1BF10	221-1BH00	221-1BH51	221-1FF50		
221-1BF21	221-1BH10	221-1FD00	221-2BL10		
221-1BF30	221-1BH30	221-1FF20	KSD221-1BH00		

Order number	221-1BF00	221-1BF10	221-1BF21	221-1BF30
Figure				
Type	SM 221	SM 221	SM 221	SM 221
General information				
Note	-	-	-	-
Features	▶ 8 inputs	▶ 8 inputs, ▶ Delay time 0.2 ms	▶ 8 alarm inputs ▶ Delay time 0.2 ms	▶ 8 inputs
Current consumption/power loss				
Current consumption from backplane bus	25 mA	25 mA	25 mA	25 mA
Power loss	2 W	2 W	2 W	2 W
Technical data digital inputs				
Number of inputs	8	8	8	8
Cable length, shielded	1000 m	1000 m	1000 m	1000 m
Cable length, unshielded	600 m	600 m	600 m	600 m
Rated load voltage	-	-	-	-
Current consumption from load voltage L+ (without load)	-	-	-	-
Rated value	DC 20.4...28.8 V	DC 20.4...28.8 V	DC 20.4...28.8 V	DC 20.4...28.8 V
Input voltage for signal "0"	DC 0...5 V	DC 0...5 V	DC 0...5 V	DC 0...5 V
Input voltage for signal "1"	DC 15...28.8 V	DC 15...28.8 V	DC 15...28.8 V	DC 15...28.8 V
Input voltage hysteresis	-	-	-	-
Frequency range	-	-	-	-
Input resistance	-	-	-	-
Input current for signal "1"	7 mA	7 mA	7 mA	7 mA
Connection of Two-Wire-BEROs possible	✓	✓	✓	✓
Max. permissible BERO quiescent current	1.5 mA	1.5 mA	1.5 mA	1.5 mA
Input delay of "0" to "1"	3 ms	0.2 ms	0.2 ms	3 ms
Input delay of "1" to "0"	3 ms	0.2 ms	0.2 ms	3 ms
Number of simultaneously utilizable inputs horizontal configuration	8	8	8	8
Number of simultaneously utilizable inputs vertical configuration	8	8	8	8
Input characteristic curve	IEC 61131-2, type 1	IEC 61131-2, type 1	IEC 61131-2, type 1	IEC 61131-2, type 1
Initial data size	1 Byte	1 Byte	1 Byte	1 Byte
Status information, alarms, diagnostics				
Status display	green LED per channel	green LED per channel	green LED per channel	green LED per channel
Interrupts	no	no	no	no
Process alarm	no	no	no	no
Diagnostic interrupt	no	no	no	no
Diagnostic functions	no	no	no	no
Diagnostics information read-out	none	none	none	none
Supply voltage display	none	none	none	none
Group error display	none	none	none	none

SLIO
100V
200V
300S
500S
HMI
Teleservice
StarterKits
Safety
Solutions
Software
Accessories
Appendix

Signal modules digital Digital input modules						
221-1BF00	221-1BF50	221-1BH50	221-1FF30	KS221-1BH00		
221-1BF10	221-1BH00	221-1BH51	221-1FF50			
221-1BF21	221-1BH10	221-1FD00	221-2BL10			
221-1BF30	221-1BH30	221-1FF20	KSD221-1BH00			

Order number	221-1BF00	221-1BF10	221-1BF21	221-1BF30
Channel error display	none	none	none	none
Isolation				
Between channels	-	-	-	-
Between channels of groups to	8	8	8	8
Between channels and backplane bus	✓	✓	✓	✓
Insulation tested with	DC 500 V	DC 500 V	DC 500 V	DC 500 V
Datasizes				
Input bytes	1	1	1	1
Output bytes	0	0	0	0
Parameter bytes	0	0	0	0
Diagnostic bytes	0	0	0	0
Housing				
Material	PPE / PA 6.6	PPE / PA 6.6	PPE / PA 6.6	PPE / PA 6.6
Mounting	Profile rail 35 mm	Profile rail 35 mm	Profile rail 35 mm	Profile rail 35 mm
Mechanical data				
Dimensions (WxHxD)	25.4 mm x 76 mm x 88 mm	25.4 mm x 76 mm x 88 mm	25.4 mm x 76 mm x 88 mm	25.4 mm x 76 mm x 88 mm
Weight	60 g	90 g	90 g	90 g
Environmental conditions				
Operating temperature	0 °C to 60 °C	0 °C to 60 °C	0 °C to 60 °C	0 °C to 60 °C
Storage temperature	-25 °C to 70 °C	-25 °C to 70 °C	-25 °C to 70 °C	-25 °C to 70 °C
Certifications				
UL508 certification	yes	yes	yes	yes

Connections, Interfaces

Signal modules digital | Digital input modules

221-1BF00	221-1BF50	221-1BH50	221-1FF30	KS221-1BH00		
221-1BF10	221-1BH00	221-1BH51	221-1FF50			
221-1BF21	221-1BH10	221-1FD00	221-2BL10			
221-1BF30	221-1BH30	221-1FF20	KSD221-1BH00			

221-1BF00

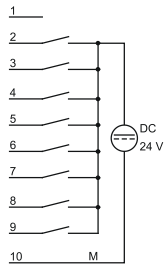

221-1BF10

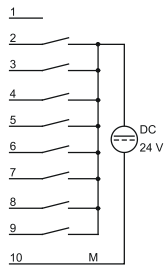

221-1BF21

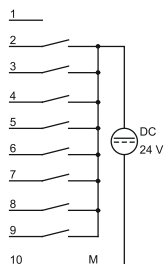



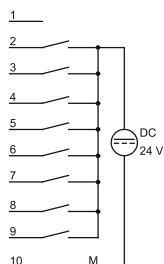

221-1BF30



Digital input modules

Signal modules digital | Digital input modules

221-1BF00 221-1BF10 221-1BF21 221-1BF30	221-1BF50 221-1BH00 221-1BH10 221-1BH30	221-1BH50 221-1BH51 221-1FD00 221-1FF20	221-1FF30 221-1FF50 221-2BL10 KSD221-1BH00	KS221-1BH00		
--	--	--	---	-------------	--	--

Order number	221-1BF50	221-1BH00	221-1BH10	221-1BH30
Figure				
Type	SM 221	SM 221	SM 221	SM 221
General information				
Note	-	-	-	-
Features	<ul style="list-style-type: none"> ▸ 8 inputs ▸ Active low input 	<ul style="list-style-type: none"> ▸ 16 inputs ▸ LED status display on the conversion module UB4x 	▸ 16 inputs	▸ 16 inputs
Current consumption/power loss				
Current consumption from backplane bus	10 mA	35 mA	40 mA	45 mA
Power loss	2 W	3.5 W	3.5 W	3.5 W
Technical data digital inputs				
Number of inputs	8	16	16	16
Cable length, shielded	1000 m	1000 m	1000 m	1000 m
Cable length, unshielded	600 m	600 m	600 m	600 m
Rated load voltage	-	-	-	-
Current consumption from load voltage L+ (without load)	-	-	-	-
Rated value	DC 20.4...28.8 V	DC 20.4...28.8 V	DC 20.4...28.8 V	DC 20.4...28.8 V
Input voltage for signal "0"	DC 15...28.8 V	DC 0...5 V	DC 0...5 V	DC 0...5 V
Input voltage for signal "1"	DC 0...5 V	DC 15...28.8 V	DC 15...28.8 V	DC 15...28.8 V
Input voltage hysteresis	-	-	-	-
Frequency range	-	-	-	-
Input resistance	-	-	-	-
Input current for signal "1"	7 mA	7 mA	7 mA	7 mA
Connection of Two-Wire-BEROs possible	✓	✓	✓	✓
Max. permissible BERO quiescent current	1.5 mA	1.5 mA	1.5 mA	1.5 mA
Input delay of "0" to "1"	3 ms	3 ms	3 ms	3 ms
Input delay of "1" to "0"	3 ms	3 ms	3 ms	3 ms
Number of simultaneously utilizable inputs horizontal configuration	8	16	16	16
Number of simultaneously utilizable inputs vertical configuration	8	16	16	16
Input characteristic curve	-	IEC 61131-2, type 1	IEC 61131-2, type 1	IEC 61131-2, type 1
Initial data size	1 Byte	2 Byte	2 Byte	2 Byte

Signal modules digital Digital input modules						
221-1BF00	221-1BF50	221-1BH50	221-1FF30	KS221-1BH00		
221-1BF10	221-1BH00	221-1BH51	221-1FF50			
221-1BF21	221-1BH10	221-1FD00	221-2BL10			
221-1BF30	221-1BH30	221-1FF20	KSD221-1BH00			

Order number	221-1BF50	221-1BH00	221-1BH10	221-1BH30
Status information, alarms, diagnostics				
Status display	green LED per channel	none	green LED per channel	green LED per channel
Interrupts	no	no	no	no
Process alarm	no	no	no	no
Diagnostic interrupt	no	no	no	no
Diagnostic functions	no	no	no	no
Diagnostics information read-out	none	none	none	none
Supply voltage display	none	none	none	none
Group error display	none	none	none	none
Channel error display	none	none	none	none
Isolation				
Between channels	-	-	-	-
Between channels of groups to	8	16	16	16
Between channels and backplane bus	✓	✓	✓	✓
Insulation tested with	DC 500 V	DC 500 V	DC 500 V	DC 500 V
Datasizes				
Input bytes	1	2	2	2
Output bytes	0	0	0	0
Parameter bytes	0	0	0	0
Diagnostic bytes	0	0	0	0
Housing				
Material	PPE / PA 6.6	PPE / PA 6.6	PPE / PA 6.6	PPE / PA 6.6
Mounting	Profile rail 35 mm	Profile rail 35 mm	Profile rail 35 mm	Profile rail 35 mm
Mechanical data				
Dimensions (WxHxD)	25.4 mm x 76 mm x 88 mm	25.4 mm x 76 mm x 88 mm	25.4 mm x 76 mm x 88 mm	25.4 mm x 76 mm x 88 mm
Weight	100 g	70 g	90 g	90 g
Environmental conditions				
Operating temperature	0 °C to 60 °C	0 °C to 60 °C	0 °C to 60 °C	0 °C to 60 °C
Storage temperature	-25 °C to 70 °C	-25 °C to 70 °C	-25 °C to 70 °C	-25 °C to 70 °C
Certifications				
UL508 certification	yes	yes	yes	yes

SLIO
100V
200V
300S
500S
HMI
Teleservice
StarterKits
Safety
Solutions
Software
Accessories
Appendix

Connections, Interfaces

Signal modules digital | Digital input modules

221-1BF00 221-1BF10 221-1BF21 221-1BF30	221-1BF50 221-1BH00 221-1BH10 221-1BH30	221-1BH50 221-1BH51 221-1FD00 221-1FF20	221-1FF30 221-1FF50 221-2BL10 KSD221-1BH00	KS221-1BH00		
--	--	--	---	-------------	--	--

221-1BF50

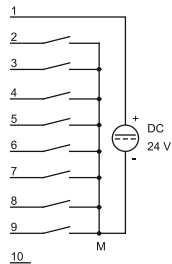

221-1BH00

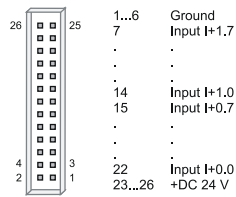

DI 16x

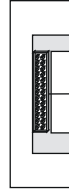

DEA-KB89 oder
DEA-KB91

UB4x

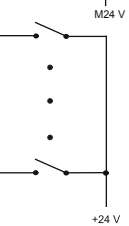
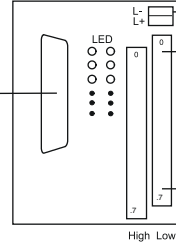

221-1BH10

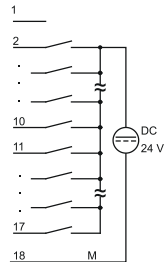

221-1BH30

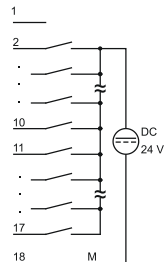

Digital input modules

Signal modules digital Digital input modules					
221-1BF00	221-1BF50	221-1BH50	221-1FF30	KS221-1BH00	
221-1BF10	221-1BH00	221-1BH51	221-1FF50		
221-1BF21	221-1BH10	221-1FD00	221-2BL10		
221-1BF30	221-1BH30	221-1FF20	KSD221-1BH00		

Order number	221-1BH50	221-1BH51	221-1FD00	221-1FF20
Figure				
Type	SM 221	SM 221	SM 221	SM 221
General information				
Note	-	-	-	-
Features	<ul style="list-style-type: none"> ▶ 16 inputs ▶ Active low input ▶ LED status display on conversion module UB4x 	<ul style="list-style-type: none"> ▶ 16 inputs ▶ Active low input 	<ul style="list-style-type: none"> ▶ 4 inputs ▶ AC/DC 90...230 V ▶ Isolation per channel 	<ul style="list-style-type: none"> ▶ 8 inputs ▶ AC/DC 60...230 V
Current consumption/power loss				
Current consumption from backplane bus	40 mA	20 mA	40 mA	60 mA
Power loss	3.5 W	3.5 W	2 W	3 W
Technical data digital inputs				
Number of inputs	16	16	4	8
Cable length, shielded	1000 m	1000 m	1000 m	1000 m
Cable length, unshielded	600 m	600 m	600 m	600 m
Rated load voltage	-	-	-	-
Current consumption from load voltage L+ (without load)	-	-	-	-
Rated value	DC 20.4...28.8 V	DC 20.4...28.8 V	AC/DC 90...230 V	AC/DC 60...230 V
Input voltage for signal "0"	DC 15...28.8 V	DC 15...28.8 V	AC/DC 0...35 V	AC/DC 0...35 V
Input voltage for signal "1"	DC 0...5 V	DC 0...5 V	AC/DC 90...230 V	AC/DC 60...230 V
Input voltage hysteresis	-	-	-	-
Frequency range	-	-	50...60 Hz	50...60 Hz
Input resistance	-	-	136 kΩ	136 kΩ
Input current for signal "1"	7 mA	7 mA	-	-
Connection of Two-Wire-BEROs possible	✓	✓	-	-
Max. permissible BERO quiescent current	1.5 mA	1.5 mA	-	-
Input delay of "0" to "1"	3 ms	3 ms	25 ms	25 ms
Input delay of "1" to "0"	3 ms	3 ms	25 ms	25 ms
Number of simultaneously utilizable inputs horizontal configuration	16	16	4	8
Number of simultaneously utilizable inputs vertical configuration	16	16	4	8
Input characteristic curve	-	-	-	-
Initial data size	2 Byte	2 Byte	4 Bit	1 Byte

SLIO
100V
200V
300S
500S
HMI
Teleservice
StarterKits
Safety
Solutions
Software
Accessories
Appendix

Signal modules digital Digital input modules						
221-1BF00	221-1BF50	221-1BH50	221-1FF30	KS221-1BH00		
221-1BF10	221-1BH00	221-1BH51	221-1FF50			
221-1BF21	221-1BH10	221-1FD00	221-2BL10			
221-1BF30	221-1BH30	221-1FF20	KSD221-1BH00			

Order number	221-1BH50	221-1BH51	221-1FD00	221-1FF20
Status information, alarms, diagnostics				
Status display	none	green LED per channel	green LED per channel	green LED per channel
Interrupts	no	no	no	no
Process alarm	no	no	no	no
Diagnostic interrupt	no	no	no	no
Diagnostic functions	no	no	no	no
Diagnostics information read-out	none	none	none	none
Supply voltage display	none	none	none	none
Group error display	none	none	none	none
Channel error display	none	none	none	none
Isolation				
Between channels	-	-	✓	-
Between channels of groups to	16	16	1	8
Between channels and backplane bus	✓	✓	✓	✓
Insulation tested with	DC 500 V	DC 500 V	DC 500 V	DC 500 V
Datasizes				
Input bytes	2	2	1	1
Output bytes	0	0	0	0
Parameter bytes	0	0	0	0
Diagnostic bytes	0	0	0	0
Housing				
Material	PPE / PA 6.6	PPE / PA 6.6	PPE / PA 6.6	PPE / PA 6.6
Mounting	Profile rail 35 mm	Profile rail 35 mm	Profile rail 35 mm	Profile rail 35 mm
Mechanical data				
Dimensions (WxHxD)	25.4 mm x 76 mm x 88 mm	25.4 mm x 76 mm x 88 mm	25.4 mm x 76 mm x 88 mm	25.4 mm x 76 mm x 88 mm
Weight	70 g	90 g	90 g	100 g
Environmental conditions				
Operating temperature	0 °C to 60 °C	0 °C to 60 °C	0 °C to 60 °C	0 °C to 60 °C
Storage temperature	-25 °C to 70 °C	-25 °C to 70 °C	-25 °C to 70 °C	-25 °C to 70 °C
Certifications				
UL508 certification	yes	yes	yes	yes

Connections, Interfaces

Signal modules digital | Digital input modules

221-1BF00 221-1BF10 221-1BF21 221-1BF30	221-1BF50 221-1BH00 221-1BH10 221-1BH30	221-1BH50 221-1BH51 221-1FD00 221-1FF20	221-1FF30 221-1FF50 221-2BL10 KSD221-1BH00	KS221-1BH00		
--	--	--	---	-------------	--	--

221-1BH50

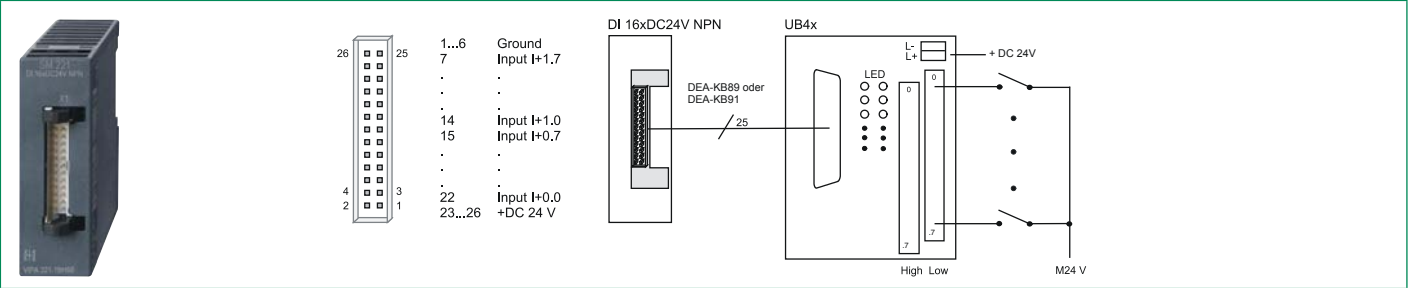

221-1BH51

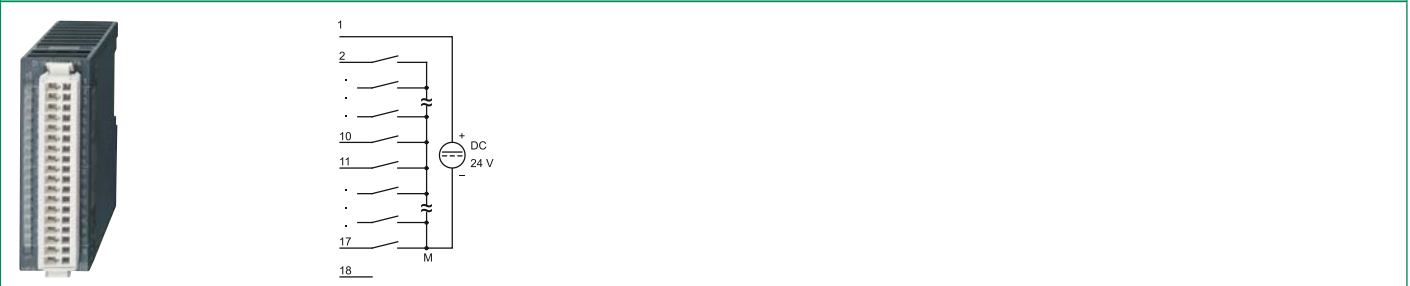

221-1FD00

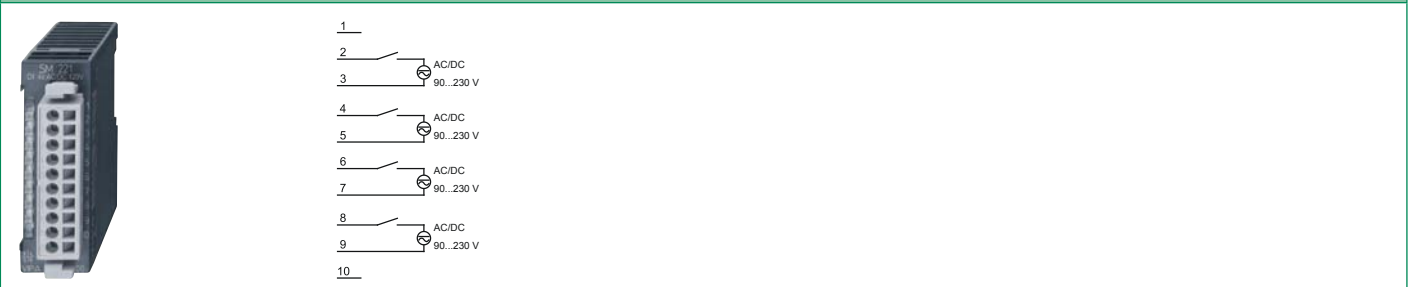



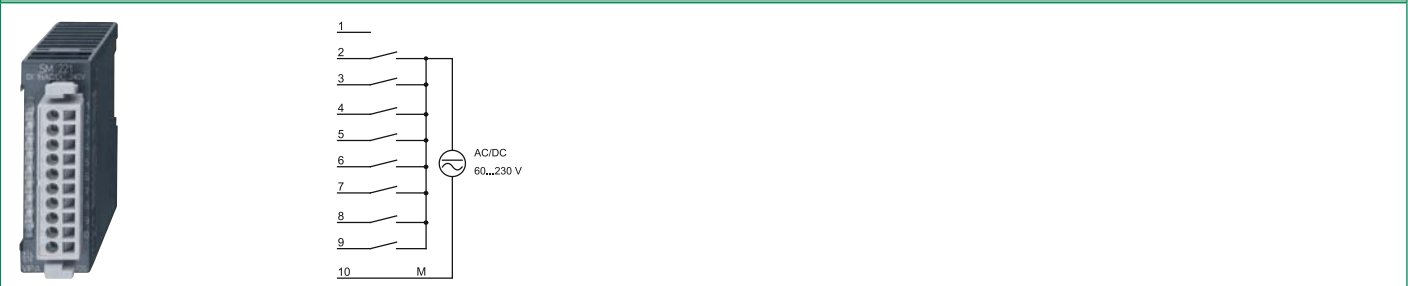

221-1FF20



Digital input modules

Signal modules digital | Digital input modules

221-1BF00 221-1BF10 221-1BF21 221-1BF30	221-1BF50 221-1BH00 221-1BH10 221-1BH30	221-1BH50 221-1BH51 221-1FD00 221-1FF20	221-1FF30 221-1FF50 221-2BL10 KSD221-1BH00	KS221-1BH00		
--	--	--	---	-------------	--	--

Order number	221-1FF30	221-1FF50	221-2BL10	KSD221-1BH00
Figure				
Type	SM 221	SM 221	SM 221	SM 221, Set
General information				
Note	-	-	-	-
Features	<ul style="list-style-type: none"> ▶ 8 inputs ▶ AC/DC 24...48 V 	<ul style="list-style-type: none"> ▶ 8 inputs ▶ AC 180...265 V 	<ul style="list-style-type: none"> ▶ 32 inputs 	<ul style="list-style-type: none"> ▶ 16 inputs ▶ LED status display on conversion module UB48D
Current consumption/power loss				
Current consumption from backplane bus	60 mA	80 mA	40 mA	35 mA
Power loss	2 W	3 W	6.5 W	3.5 W
Technical data digital inputs				
Number of inputs	8	8	32	16
Cable length, shielded	1000 m	1000 m	1000 m	1000 m
Cable length, unshielded	600 m	600 m	600 m	600 m
Rated load voltage	-	-	-	-
Current consumption from load voltage L+ (without load)	-	-	-	-
Rated value	AC/DC 24...48 V	AC/DC 180...265 V	DC 20.4...28.8 V	DC 20.4...28.8 V
Input voltage for signal "0"	AC/DC 0...8 V	AC/DC 0...150 V	DC 0...5 V	DC 0...5 V
Input voltage for signal "1"	AC/DC 18...48 V	AC/DC 180...265 V	DC 15...28.8 V	DC 15...28.8 V
Input voltage hysteresis	-	-	-	-
Frequency range	50...60 Hz	50...60 Hz	-	-
Input resistance	16.4 kΩ	136 kΩ	-	-
Input current for signal "1"	-	-	7 mA	7 mA
Connection of Two-Wire-BEROs possible	-	-	✓	✓
Max. permissible BERO quiescent current	-	-	1.5 mA	1.5 mA
Input delay of "0" to "1"	25 ms	25 ms	3 ms	3 ms
Input delay of "1" to "0"	25 ms	25 ms	3 ms	3 ms
Number of simultaneously utilizable inputs horizontal configuration	8	8	16	16
Number of simultaneously utilizable inputs vertical configuration	8	8	16	16
Input characteristic curve	-	-	IEC 61131-2, type 1	IEC 61131-2, type 1
Initial data size	1 Byte	1 Byte	4 Byte	2 Byte

Signal modules digital Digital input modules						
221-1BF00	221-1BF50	221-1BH50	221-1FF30	KS221-1BH00		
221-1BF10	221-1BH00	221-1BH51	221-1FF50			
221-1BF21	221-1BH10	221-1FD00	221-2BL10			
221-1BF30	221-1BH30	221-1FF20	KSD221-1BH00			

Order number	221-1FF30	221-1FF50	221-2BL10	KSD221-1BH00
Status information, alarms, diagnostics				
Status display	green LED per channel	green LED per channel	green LED per channel	none
Interrupts	no	no	no	no
Process alarm	no	no	no	no
Diagnostic interrupt	no	no	no	no
Diagnostic functions	no	no	no	no
Diagnostics information read-out	none	none	none	none
Supply voltage display	none	none	none	none
Group error display	none	none	none	none
Channel error display	none	none	none	none
Isolation				
Between channels	-	-	-	-
Between channels of groups to	8	8	16	16
Between channels and backplane bus	✓	✓	✓	✓
Insulation tested with	DC 500 V	DC 500 V	DC 500 V	DC 500 V
Datasizes				
Input bytes	1	1	4	2
Output bytes	0	0	0	0
Parameter bytes	0	0	0	0
Diagnostic bytes	0	0	0	0
Housing				
Material	PPE / PA 6.6	PPE / PA 6.6	PPE / PA 6.6	PPE / PA 6.6
Mounting	Profile rail 35 mm	Profile rail 35 mm	Profile rail 35 mm	Profile rail 35 mm
Mechanical data				
Dimensions (WxHxD)	25.4 mm x 76 mm x 88 mm	25.4 mm x 76 mm x 88 mm	50.8 mm x 76 mm x 88 mm	25.4 mm x 76 mm x 88 mm
Weight	90 g	90 g	140 g	70 g
Environmental conditions				
Operating temperature	0 °C to 60 °C	0 °C to 60 °C	0 °C to 60 °C	0 °C to 60 °C
Storage temperature	-25 °C to 70 °C	-25 °C to 70 °C	-25 °C to 70 °C	-25 °C to 70 °C
Certifications				
UL508 certification	yes	yes	yes	yes

Connections, Interfaces

Signal modules digital | Digital input modules

221-1BF00 221-1BF10 221-1BF21 221-1BF30	221-1BF50 221-1BH00 221-1BH10 221-1BH30	221-1BH50 221-1BH51 221-1FD00 221-1FF20	221-1FF30 221-1FF50 221-2BL10 KSD221-1BH00	KS221-1BH00		
--	--	--	---	-------------	--	--

221-1FF30

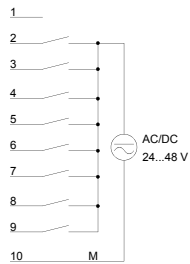

221-1FF50

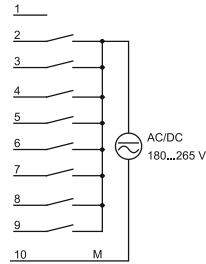

221-2BL10

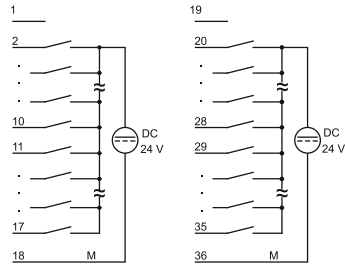

KSD221-1BH00

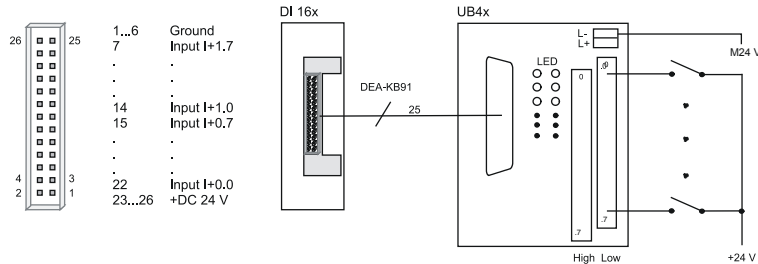

Digital input modules

Signal modules digital Digital input modules						
221-1BF00	221-1BF50	221-1BH50	221-1FF30	KS221-1BH00		
221-1BF10	221-1BH00	221-1BH51	221-1FF50			
221-1BF21	221-1BH10	221-1FD00	221-2BL10			
221-1BF30	221-1BH30	221-1FF20	KSD221-1BH00			

Order number	KS221-1BH00			
Figure				
Type	SM 221, Set			
General information				
Note	-			
Features	<ul style="list-style-type: none"> ▸ 16 inputs ▸ LED status display on conversion module UB48 			
Current consumption/power loss				
Current consumption from backplane bus	35 mA			
Power loss	3.5 W			
Technical data digital inputs				
Number of inputs	16			
Cable length, shielded	1000 m			
Cable length, unshielded	600 m			
Rated load voltage	-			
Current consumption from load voltage L+ (without load)	-			
Rated value	DC 20.4...28.8 V			
Input voltage for signal "0"	DC 0...5 V			
Input voltage for signal "1"	DC 15...28.8 V			
Input voltage hysteresis	-			
Frequency range	-			
Input resistance	-			
Input current for signal "1"	7 mA			
Connection of Two-Wire-BEROs possible	✓			
Max. permissible BERO quiescent current	1.5 mA			
Input delay of "0" to "1"	3 ms			
Input delay of "1" to "0"	3 ms			
Number of simultaneously utilizable inputs horizontal configuration	16			
Number of simultaneously utilizable inputs vertical configuration	16			
Input characteristic curve	IEC 61131-2, type 1			
Initial data size	2 Byte			

Signal modules digital Digital input modules						
221-1BF00	221-1BF50	221-1BH50	221-1FF30	KS221-1BH00		
221-1BF10	221-1BH00	221-1BH51	221-1FF50			
221-1BF21	221-1BH10	221-1FD00	221-2BL10			
221-1BF30	221-1BH30	221-1FF20	KSD221-1BH00			

Order number	KS221-1BH00			
Status information, alarms, diagnostics				
Status display	none			
Interrupts	no			
Process alarm	no			
Diagnostic interrupt	no			
Diagnostic functions	no			
Diagnostics information read-out	none			
Supply voltage display	none			
Group error display	none			
Channel error display	none			
Isolation				
Between channels	-			
Between channels of groups to	16			
Between channels and backplane bus	✓			
Insulation tested with	DC 500 V			
Datasizes				
Input bytes	2			
Output bytes	0			
Parameter bytes	0			
Diagnostic bytes	0			
Housing				
Material	PPE / PA 6.6			
Mounting	Profile rail 35 mm			
Mechanical data				
Dimensions (WxHxD)	25.4 mm x 76 mm x 88 mm			
Weight	70 g			
Environmental conditions				
Operating temperature	0 °C to 60 °C			
Storage temperature	-25 °C to 70 °C			
Certifications				
UL508 certification	yes			

Connections, Interfaces

Signal modules digital | Digital input modules

221-1BF00	221-1BF50	221-1BH50	221-1FF30	KS221-1BH00		
221-1BF10	221-1BH00	221-1BH51	221-1FF50			
221-1BF21	221-1BH10	221-1FD00	221-2BL10			
221-1BF30	221-1BH30	221-1FF20	KSD221-1BH00			

KS221-1BH00

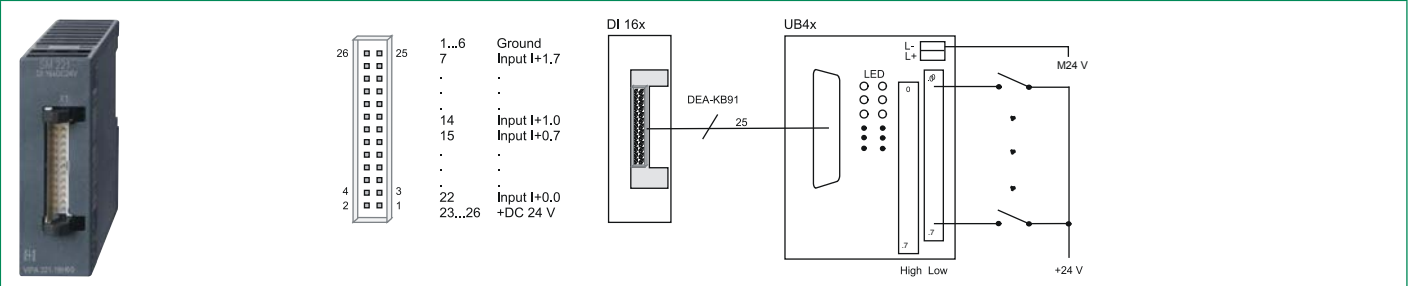

Digital input with counter

Signal modules digital | Digital input with counter

221-1BH20

Order number	221-1BH20			
Figure				
Type	SM 221			
General information				
Note	-			
Features	<ul style="list-style-type: none"> ▶ 16 inputs ▶ 2 inputs are configurable as counter ▶ LED status display 			
Current consumption/power loss				
Current consumption from backplane bus	85 mA			
Power loss	3.5 W			
Technical data digital inputs				
Number of inputs	16			
Cable length, shielded	1000 m			
Cable length, unshielded	600 m			
Rated load voltage	-			
Reverse polarity protection of rated load voltage	-			
Current consumption from load voltage L+ (without load)	-			
Rated value	DC 20.4...28.8 V			
Input voltage for signal "0"	DC 0...5 V			
Input voltage for signal "1"	DC 15...28.8 V			
Input voltage hysteresis	-			
Frequency range	-			
Input resistance	-			
Input current for signal "1"	7 mA			
Connection of Two-Wire-BERs possible	✓			
Max. permissible BERO quiescent current	1.5 mA			
Input delay of "0" to "1"	3 ms			
Input delay of "1" to "0"	3 ms			
Number of simultaneously utilizable inputs horizontal configuration	16			
Number of simultaneously utilizable inputs vertical configuration	16			
Input characteristic curve	IEC 61131-2, type 1			
Initial data size	6 Byte			

Signal modules digital Digital input with counter						
221-1BH20						

Order number	221-1BH20			
Technical data counters				
Number of counters	1			
Counter width	32 Bit			
Maximum input frequency	100 kHz			
Maximum count frequency	400 kHz			
Mode incremental encoder	✓			
Mode pulse / direction	✓			
Mode pulse	✓			
Mode frequency counter	✓			
Mode period measurement	✓			
Gate input available	-			
Latch input available	-			
Reset input available	-			
Counter output available	-			
Status information, alarms, diagnostics				
Status display	green LED per channel			
Interrupts	no			
Process alarm	no			
Diagnostic interrupt	no			
Diagnostic functions	no			
Diagnostics information read-out	none			
Supply voltage display	none			
Group error display	none			
Channel error display	none			
Isolation				
Between channels	-			
Between channels of groups to	16			
Between channels and backplane bus	✓			
Insulation tested with	DC 500 V			
Datasizes				
Input bytes	6			
Output bytes	6			
Parameter bytes	5			
Diagnostic bytes	0			
Housing				
Material	PPE / PA 6.6			
Mounting	Profile rail 35 mm			
Mechanical data				
Dimensions (WxHxD)	25.4 mm x 76 mm x 88 mm			
Weight	90 g			
Environmental conditions				
Operating temperature	0 °C to 60 °C			
Storage temperature	-25 °C to 70 °C			
Certifications				
UL508 certification	yes			

- SLIO
- 100V
- 200V
- 300S
- 500S
- HMI
- Teleservice
- StarterKits
- Safety
- Solutions
- Software
- Accessories
- Appendix

Connections, Interfaces

Signal modules digital | Digital input with counter

221-1BH20



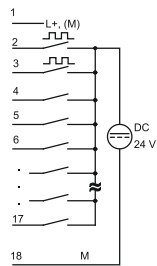

221-1BH20



Digital output modules

Signal modules digital | Digital output modules

222-1BF00 222-1BF10 222-1BF20 222-1BF30	222-1BF50 222-1BH00 222-1BH10 222-1BH20	222-1BH30 222-1BH50 222-1BH51 222-1DB00	222-1FF00 222-1HD10 222-1HD20 222-1HF00	222-2BL10 KSD222-1BH00 KS222-1BH00		
--	--	--	--	--	--	--

Order number	222-1BF00	222-1BF10	222-1BF20	222-1BF30
Figure				
Type	SM 222	SM 222	SM 222	SM 222, ECO
General information				
Note	-	-	-	-
Features	<ul style="list-style-type: none"> ▶ 8 outputs ▶ Output current 1 A 	<ul style="list-style-type: none"> ▶ 8 outputs ▶ Output current 2 A 	<ul style="list-style-type: none"> ▶ 8 outputs ▶ Isolation in 4 groups per 2 outputs ▶ Output current 2 A 	<ul style="list-style-type: none"> ▶ 8 outputs ▶ Output current 0.5 A
Current consumption/power loss				
Current consumption from backplane bus	70 mA	70 mA	70 mA	70 mA
Power loss	2 W	3 W	3 W	2 W
Technical data digital outputs				
Number of outputs	8	8	8	8
Cable length, shielded	1000 m	1000 m	1000 m	1000 m
Cable length, unshielded	600 m	600 m	600 m	600 m
Rated load voltage	DC 20.4...28.8 V	DC 20.4...28.8 V	DC 20.4...28.8 V	DC 20.4...28.8 V
Current consumption from load voltage L+ (without load)	10 mA	10 mA	10 mA	10 mA
Total current per group, horizontal configuration, 40°C	8 A	10 A	4 A	4 A
Total current per group, horizontal configuration, 60°C	8 A	10 A	4 A	4 A
Total current per group, vertical configuration	8 A	10 A	4 A	4 A
Output current at signal "1", rated value	1 A	2 A	2 A	0.5 A
Output delay of "0" to "1"	150 µs	150 µs	150 µs	max. 100 µs
Output delay of "1" to "0"	100 µs	100 µs	100 µs	max. 350 µs
Minimum load current	-	-	-	-
Lamp load	5 W	5 W	5 W	5 W
Parallel switching of outputs for redundant control of a load	not possible	not possible	not possible	not possible
Parallel switching of outputs for increased power	not possible	not possible	not possible	not possible
Actuation of digital input	✓	✓	✓	✓
Switching frequency with resistive load	max. 1000 Hz	max. 1000 Hz	max. 1000 Hz	max. 1000 Hz
Switching frequency with inductive load	max. 0.5 Hz	max. 0.5 Hz	max. 0.5 Hz	max. 0.5 Hz
Switching frequency on lamp load	max. 10 Hz	max. 10 Hz	max. 10 Hz	max. 10 Hz
Internal limitation of inductive shut-off voltage	L+ (-52 V)	L+ (-52 V)	L+ (-52 V)	L+ (-52 V)
Short-circuit protection of output	yes, electronic	yes, electronic	yes, electronic	yes, electronic
Trigger level	1.5 A	3 A	3 A	1 A
Number of operating cycle of relay outputs	-	-	-	-
Switching capacity of contacts	-	-	-	-
Output data size	1 Byte	1 Byte	1 Byte	1 Byte

Signal modules digital Digital output modules						
222-1BF00	222-1BF50	222-1BH30	222-1FF00	222-2BL10		
222-1BF10	222-1BH00	222-1BH50	222-1HD10	KSD222-1BH00		
222-1BF20	222-1BH10	222-1BH51	222-1HD20	KS222-1BH00		
222-1BF30	222-1BH20	222-1DB00	222-1HF00			

Order number	222-1BF00	222-1BF10	222-1BF20	222-1BF30
Status information, alarms, diagnostics				
Status display	green LED per channel	green LED per channel	green LED per channel	green LED per channel
Interrupts	no	no	no	no
Process alarm	no	no	no	no
Diagnostic interrupt	no	no	no	no
Diagnostic functions	no	no	no	no
Diagnostics information read-out	none	none	none	none
Supply voltage display	green LED per group	green LED per group	green LED per group	green LED per group
Group error display	red SF LED	red SF LED	red LED per group	red SF LED
Channel error display	none	none	none	none
Isolation				
Between channels	-	-	✓	-
Between channels of groups to	8	8	2	8
Between channels and backplane bus	✓	✓	✓	✓
Insulation tested with	DC 500 V	DC 500 V	DC 500 V	DC 500 V
Datasizes				
Input bytes	0	0	0	0
Output bytes	1	1	1	1
Parameter bytes	0	0	0	0
Diagnostic bytes	0	0	0	0
Housing				
Material	PPE / PA 6.6	PPE / PA 6.6	PPE / PA 6.6	PPE / PA 6.6
Mounting	Profile rail 35 mm	Profile rail 35 mm	Profile rail 35 mm	Profile rail 35 mm
Mechanical data				
Dimensions (WxHxD)	25.4 mm x 76 mm x 88 mm	25.4 mm x 76 mm x 88 mm	25.4 mm x 76 mm x 88 mm	25.4 mm x 76 mm x 88 mm
Weight	100 g	100 g	90 g	90 g
Environmental conditions				
Operating temperature	0 °C to 60 °C	0 °C to 60 °C	0 °C to 60 °C	0 °C to 60 °C
Storage temperature	-25 °C to 70 °C	-25 °C to 70 °C	-25 °C to 70 °C	-25 °C to 70 °C
Certifications				
UL508 certification	yes	yes	yes	yes

Connections, Interfaces

Signal modules digital | Digital output modules

222-1BF00	222-1BF50	222-1BH30	222-1FF00	222-2BL10		
222-1BF10	222-1BH00	222-1BH50	222-1HD10	KSD222-1BH00		
222-1BF20	222-1BH10	222-1BH51	222-1HD20	KS222-1BH00		
222-1BF30	222-1BH20	222-1DB00	222-1HF00			

222-1BF00

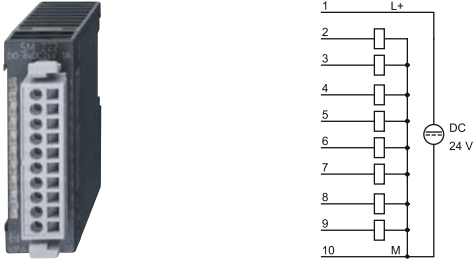

The 222-1BF00 module is a 10-channel digital output module. The wiring diagram shows 10 channels (terminals 2-11) connected to a common DC 24V supply. Terminal 1 is L+, terminal 10 is M, and terminal 11 is the common DC 24V supply.

222-1BF10

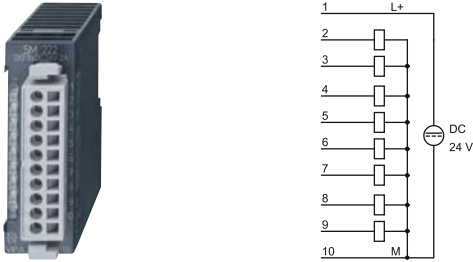

The 222-1BF10 module is a 10-channel digital output module. The wiring diagram shows 10 channels (terminals 2-11) connected to a common DC 24V supply. Terminal 1 is L+, terminal 10 is M, and terminal 11 is the common DC 24V supply.

222-1BF20

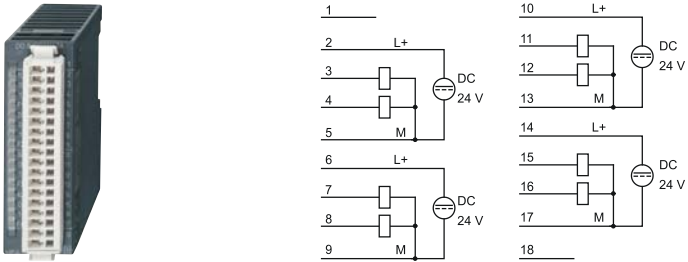

The 222-1BF20 module is a 18-channel digital output module. The wiring diagram shows three groups of channels connected to a common DC 24V supply. Group 1 (terminals 2-5) has L+ at 2, M at 5, and DC 24V at 6. Group 2 (terminals 10-13) has L+ at 10, M at 13, and DC 24V at 12. Group 3 (terminals 14-17) has L+ at 14, M at 17, and DC 24V at 16. Terminal 1 is L+, terminal 18 is M, and terminal 19 is the common DC 24V supply.

222-1BF30

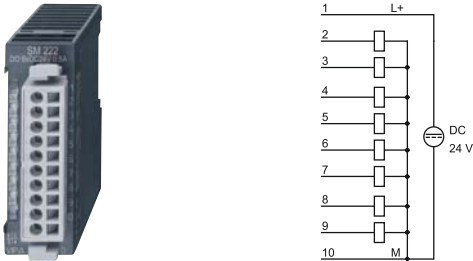

The 222-1BF30 module is a 10-channel digital output module. The wiring diagram shows 10 channels (terminals 2-11) connected to a common DC 24V supply. Terminal 1 is L+, terminal 10 is M, and terminal 11 is the common DC 24V supply.

Digital output modules

Signal modules digital | Digital output modules

222-1BF00 222-1BF10 222-1BF20 222-1BF30	222-1BF50 222-1BH00 222-1BH10 222-1BH20	222-1BH30 222-1BH50 222-1BH51 222-1DB00	222-1FF00 222-1HD10 222-1HD20 222-1HF00	222-2BL10 KSD222-1BH00 KS222-1BH00		
--	--	--	--	--	--	--

Order number	222-1BF50	222-1BH00	222-1BH10	222-1BH20
Figure				
Type	SM 222	SM 222	SM 222	SM 222
General information				
Note	-	-	-	-
Features	<ul style="list-style-type: none"> ▶ 8 Low-Side outputs ▶ Output current 0.5 A 	<ul style="list-style-type: none"> ▶ 16 outputs ▶ Output current 0.5 A ▶ LED status display on conversion module UB4x 	<ul style="list-style-type: none"> ▶ 16 outputs ▶ Output current 1 A 	<ul style="list-style-type: none"> ▶ 16 outputs ▶ Output current 2 A
Current consumption/power loss				
Current consumption from backplane bus	50 mA	120 mA	120 mA	120 mA
Power loss	1.5 W	3.5 W	3.5 W	3.5 W
Technical data digital outputs				
Number of outputs	8	16	16	16
Cable length, shielded	1000 m	1000 m	1000 m	1000 m
Cable length, unshielded	600 m	600 m	600 m	600 m
Rated load voltage	DC 20.4...28.8 V	DC 20.4...28.8 V	DC 20.4...28.8 V	DC 20.4...28.8 V
Current consumption from load voltage L+ (without load)	15 mA	10 mA	10 mA	10 mA
Total current per group, horizontal configuration, 40°C	4 A	8 A	10 A	10 A
Total current per group, horizontal configuration, 60°C	4 A	8 A	10 A	10 A
Total current per group, vertical configuration	4 A	8 A	10 A	10 A
Output current at signal "1", rated value	0.5 A	0.5 A	1 A	2 A
Output delay of "0" to "1"	30 µs	150 µs	150 µs	150 µs
Output delay of "1" to "0"	100 µs	100 µs	100 µs	100 µs
Minimum load current	-	-	-	-
Lamp load	5 W	5 W	5 W	5 W
Parallel switching of outputs for redundant control of a load	not possible	not possible	not possible	not possible
Parallel switching of outputs for increased power	not possible	not possible	not possible	not possible
Actuation of digital input	✓	✓	✓	✓
Switching frequency with resistive load	max. 1000 Hz	max. 1000 Hz	max. 1000 Hz	max. 1000 Hz
Switching frequency with inductive load	max. 0.5 Hz	max. 0.5 Hz	max. 0.5 Hz	max. 0.5 Hz
Switching frequency on lamp load	max. 10 Hz	max. 10 Hz	max. 10 Hz	max. 10 Hz
Internal limitation of inductive shut-off voltage	+45 V	L+ (-52 V)	L+ (-52 V)	L+ (-52 V)
Short-circuit protection of output	yes, electronic	yes, electronic	yes, electronic	yes, electronic
Trigger level	1.7 A	1.5 A	1.5 A	3 A
Number of operating cycle of relay outputs	-	-	-	-
Switching capacity of contacts	-	-	-	-
Output data size	1 Byte	2 Byte	2 Byte	2 Byte

Signal modules digital Digital output modules						
222-1BF00	222-1BF50	222-1BH30	222-1FF00	222-2BL10		
222-1BF10	222-1BH00	222-1BH50	222-1HD10	KSD222-1BH00		
222-1BF20	222-1BH10	222-1BH51	222-1HD20	KS222-1BH00		
222-1BF30	222-1BH20	222-1DB00	222-1HF00			

Order number	222-1BF50	222-1BH00	222-1BH10	222-1BH20
Status information, alarms, diagnostics				
Status display	green LED per channel	none	green LED per channel	green LED per channel
Interrupts	no	no	no	no
Process alarm	no	no	no	no
Diagnostic interrupt	no	no	no	no
Diagnostic functions	no	no	no	no
Diagnostics information read-out	none	none	none	none
Supply voltage display	green LED per group	none	green LED per group	green LED per group
Group error display	red SF LED	none	red SF LED	red SF LED
Channel error display	none	none	none	none
Isolation				
Between channels	-	-	-	-
Between channels of groups to	8	16	16	16
Between channels and backplane bus	✓	✓	✓	✓
Insulation tested with	DC 500 V	DC 500 V	DC 500 V	DC 500 V
Datasizes				
Input bytes	0	0	0	0
Output bytes	1	2	2	2
Parameter bytes	0	0	0	0
Diagnostic bytes	0	0	0	0
Housing				
Material	PPE / PA 6.6	PPE / PA 6.6	PPE / PA 6.6	PPE / PA 6.6
Mounting	Profile rail 35 mm	Profile rail 35 mm	Profile rail 35 mm	Profile rail 35 mm
Mechanical data				
Dimensions (WxHxD)	25.4 mm x 76 mm x 88 mm	25.4 mm x 76 mm x 88 mm	25.4 mm x 76 mm x 88 mm	25.4 mm x 76 mm x 88 mm
Weight	90 g	80 g	90 g	100 g
Environmental conditions				
Operating temperature	0 °C to 60 °C	0 °C to 60 °C	0 °C to 60 °C	0 °C to 60 °C
Storage temperature	-25 °C to 70 °C	-25 °C to 70 °C	-25 °C to 70 °C	-25 °C to 70 °C
Certifications				
UL508 certification	yes	yes	yes	yes

SLIO
100V
200V
300S
500S
HMI
Teleservice
StarterKits
Safety
Solutions
Software
Accessories
Appendix

Connections, Interfaces

Signal modules digital | Digital output modules

222-1BF00 222-1BF10 222-1BF20 222-1BF30	222-1BF50 222-1BH00 222-1BH10 222-1BH20	222-1BH30 222-1BH50 222-1BH51 222-1DB00	222-1FF00 222-1HD10 222-1HD20 222-1HF00	222-2BL10 KSD222-1BH00 KS222-1BH00		
--	--	--	--	--	--	--

222-1BF50

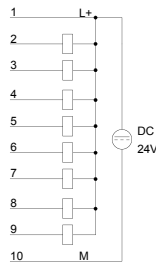

222-1BH00

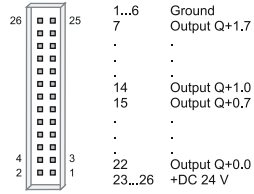

DEA-KB89 oder
DEA-KB91

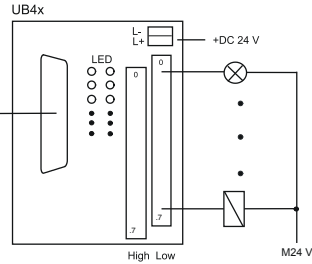

222-1BH10

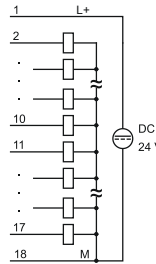



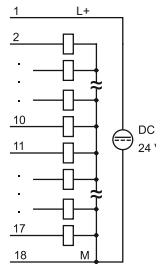

222-1BH20



Digital output modules

Signal modules digital | Digital output modules

222-1BF00 222-1BF10 222-1BF20 222-1BF30	222-1BF50 222-1BH00 222-1BH10 222-1BH20	222-1BH30 222-1BH50 222-1BH51 222-1DB00	222-1FF00 222-1HD10 222-1HD20 222-1HF00	222-2BL10 KSD222-1BH00 KS222-1BH00		
--	--	--	--	--	--	--

Order number	222-1BH30	222-1BH50	222-1BH51	222-1DB00
Figure				
Type	SM 222, ECO	SM 222	SM 222	SM 222
General information				
Note	-	-	-	-
Features	<ul style="list-style-type: none"> ▶ 16 outputs ▶ Output current 0.5 A 	<ul style="list-style-type: none"> ▶ 16 Low-Side outputs ▶ Output current 0.5 A 	<ul style="list-style-type: none"> ▶ 16 Low-Side outputs ▶ Output current 0.5A 	<ul style="list-style-type: none"> ▶ 2 outputs ▶ AC 100...240 V ▶ Output current 2 A ▶ Software dimmer for resistive, inductive or capacitive load ▶ Frequency range 47...63 Hz
Current consumption/power loss				
Current consumption from backplane bus	120 mA	120 mA	90 mA	190 mA
Power loss	3.5 W	3.5 W	2.5 W	6 W
Technical data digital outputs				
Number of outputs	16	16	16	2
Cable length, shielded	1000 m	1000 m	1000 m	1000 m
Cable length, unshielded	600 m	600 m	600 m	600 m
Rated load voltage	DC 20.4...28.8 V	DC 20.4...28.8 V	DC 20.4...28.8 V	AC 100...240 V
Current consumption from load voltage L+ (without load)	10 mA	10 mA	25 mA	15 mA
Total current per group, horizontal configuration, 40°C	8 A	8 A	8 A	4 A
Total current per group, horizontal configuration, 60°C	8 A	8 A	8 A	3 A
Total current per group, vertical configuration	8 A	8 A	8 A	4 A
Output current at signal "1", rated value	0.5 A	0.5 A	0.5 A	2 A
Output delay of "0" to "1"	max. 100 µs	100 µs	30 µs	max. 1 AC cycle
Output delay of "1" to "0"	max. 350 µs	150 µs	100 µs	max. 1 AC cycle
Minimum load current	-	-	-	-
Lamp load	5 W	5 W	5 W	460 W
Parallel switching of outputs for redundant control of a load	not possible	not possible	possible (only outputs group)	not possible
Parallel switching of outputs for increased power	not possible	not possible	not possible	not possible
Actuation of digital input	✓	✓	✓	-
Switching frequency with resistive load	max. 1000 Hz	max. 1000 Hz	max. 1000 Hz	-
Switching frequency with inductive load	max. 0.5 Hz	max. 0.5 Hz	max. 0.5 Hz	-
Switching frequency on lamp load	max. 10 Hz	max. 10 Hz	max. 10 Hz	-
Internal limitation of inductive shut-off voltage	L+ (-52 V)	+45 V	+45 V	-
Short-circuit protection of output	yes, electronic	yes, electronic	yes, electronic	yes, electronic
Trigger level	1 A	1.5 A	1.7 A	4 A

Signal modules digital Digital output modules						
222-1BF00	222-1BF50	222-1BH30	222-1FF00	222-2BL10		
222-1BF10	222-1BH00	222-1BH50	222-1HD10	KSD222-1BH00		
222-1BF20	222-1BH10	222-1BH51	222-1HD20	KS222-1BH00		
222-1BF30	222-1BH20	222-1DB00	222-1HF00			

Order number	222-1BH30	222-1BH50	222-1BH51	222-1DB00
Number of operating cycle of relay outputs	-	-	-	-
Switching capacity of contacts	-	-	-	-
Output data size	2 Byte	2 Byte	2 Byte	4 Byte
Status information, alarms, diagnostics				
Status display	green LED per channel	none	green LED per channel	none
Interrupts	no	no	no	no
Process alarm	no	no	no	no
Diagnostic interrupt	no	no	no	yes, parameterizable
Diagnostic functions	no	no	no	no
Diagnostics information read-out	none	none	none	possible
Supply voltage display	green LED per group	none	green LED per group	green LED per group
Group error display	red SF LED	none	red SF LED	red SF LED
Channel error display	none	none	none	none
Isolation				
Between channels	-	-	-	-
Between channels of groups to	16	16	16	-
Between channels and backplane bus	✓	✓	✓	✓
Insulation tested with	DC 500 V	DC 500 V	DC 500 V	DC 4000 V
Datasizes				
Input bytes	0	0	0	0
Output bytes	2	2	2	4
Parameter bytes	0	0	0	17
Diagnostic bytes	0	0	0	10
Housing				
Material	PPE / PA 6.6	PPE / PA 6.6	PPE / PA 6.6	PPE / PA 6.6
Mounting	Profile rail 35 mm	Profile rail 35 mm	Profile rail 35 mm	Profile rail 35 mm
Mechanical data				
Dimensions (WxHxD)	25.4 mm x 76 mm x 88 mm	25.4 mm x 76 mm x 88 mm	25.4 mm x 76 mm x 88 mm	25.4 mm x 76 mm x 88 mm
Weight	90 g	80 g	90 g	70 g
Environmental conditions				
Operating temperature	0 °C to 60 °C	0 °C to 60 °C	0 °C to 60 °C	0 °C to 60 °C
Storage temperature	-25 °C to 70 °C	-25 °C to 70 °C	-25 °C to 70 °C	-25 °C to 70 °C
Certifications				
UL508 certification	yes	yes	yes	-

Connections, Interfaces

Signal modules digital | Digital output modules

222-1BF00 222-1BF10 222-1BF20 222-1BF30	222-1BF50 222-1BH00 222-1BH10 222-1BH20	222-1BH30 222-1BH50 222-1BH51 222-1DB00	222-1FF00 222-1HD10 222-1HD20 222-1HF00	222-2BL10 KSD222-1BH00 KS222-1BH00		
--	--	--	--	--	--	--

222-1BH30



The image shows a 222-1BH30 digital output module and its wiring diagram. The module is a rack-mountable unit with a terminal block on the front. The wiring diagram shows a DC 24V power source connected to terminal 1 (L+). Terminals 2 through 17 are connected to a common DC 24V line through individual output relays. Terminal 18 (M) is connected to the common return of the relays.

222-1BH50



The image shows a 222-1BH50 digital output module and its wiring diagram. The module is a rack-mountable unit with a terminal block on the front. The wiring diagram shows a DC 24V power source connected to terminals 23 and 26 (L+). Terminals 22, 21, 20, 9, 8, and 7 are connected to a common DC 24V line through individual output relays. Terminal 1...6 (M) is connected to the common return of the relays.

222-1BH51



The image shows a 222-1BH51 digital output module and its wiring diagram. The module is a rack-mountable unit with a terminal block on the front. The wiring diagram shows a DC 24V power source connected to terminal 1 (L+). Terminals 2 through 17 are connected to a common DC 24V line through individual output relays. Terminal 18 (M) is connected to the common return of the relays.

222-1DB00







The image shows a 222-1DB00 digital output module and its wiring diagram. The module is a rack-mountable unit with a terminal block on the front. The wiring diagram shows an AC power source (100V to 230V) connected to terminals 1 (L) and 2. Terminals 3 and 4 are connected to a common AC line through individual output relays. Terminals 5 and 6 are connected to a common AC line through individual output relays. Terminals 7, 8, 9, and 10 (N) are connected to the common return of the relays.

Digital output modules

Signal modules digital | Digital output modules

222-1BF00 222-1BF10 222-1BF20 222-1BF30	222-1BF50 222-1BH00 222-1BH10 222-1BH20	222-1BH30 222-1BH50 222-1BH51 222-1DB00	222-1FF00 222-1HD10 222-1HD20 222-1HF00	222-2BL10 KSD222-1BH00 KS222-1BH00
--	--	--	--	--

Order number	222-1FF00	222-1HD10	222-1HD20	222-1HF00
Figure				
Type	SM 222	SM 222	SM 222	SM 222
General information				
Note	-	-	-	-
Features	<ul style="list-style-type: none"> ▸ 8 solide-state outputs ▸ AC 230 V/ DC 400 V ▸ Output current 0.5 A 	<ul style="list-style-type: none"> ▸ 4 isolated relay outputs ▸ AC 230 V/ DC 30 V ▸ Output current 5 A 	<ul style="list-style-type: none"> ▸ 4 isolated relay outputs ▸ AC 230 V/ DC 30 V ▸ Output current 16 A 	<ul style="list-style-type: none"> ▸ 8 relay outputs ▸ AC 230 V/ DC 30 V ▸ Output current 5 A
Current consumption/power loss				
Current consumption from backplane bus	150 mA	160 mA	200 mA	300 mA
Power loss	1.5 W	2 W	2 W	2 W
Technical data digital outputs				
Number of outputs	8	4	4	8
Cable length, shielded	1000 m	1000 m	1000 m	1000 m
Cable length, unshielded	600 m	600 m	600 m	600 m
Rated load voltage	AC 230 V	AC 230 V	AC 230 V	DC 30 V/ AC 230 V
Current consumption from load voltage L+ (without load)	-	-	-	-
Total current per group, horizontal configuration, 40°C	4 A	5 A	16 A	8 A
Total current per group, horizontal configuration, 60°C	4 A	5 A	16 A	8 A
Total current per group, vertical configuration	4 A	5 A	16 A	8 A
Output current at signal "1", rated value	0.5 A	5 A	16 A	5 A
Output delay of "0" to "1"	5 ms	10 ms	10 ms	10 ms
Output delay of "1" to "0"	1 ms	5 ms	10 ms	5 ms
Minimum load current	-	-	-	-
Lamp load	-	-	-	-
Parallel switching of outputs for redundant control of a load	not possible	not possible	not possible	not possible
Parallel switching of outputs for increased power	not possible	not possible	not possible	not possible
Actuation of digital input	-	-	-	-
Switching frequency with resistive load	max. 0.5 Hz	max. 10 Hz	max. 10 Hz	max. 10 Hz
Switching frequency with inductive load	-	-	-	-
Switching frequency on lamp load	-	-	-	-
Internal limitation of inductive shut-off voltage	-	-	-	-
Short-circuit protection of output	-	-	-	-
Trigger level	-	-	-	-
Number of operating cycle of relay outputs	-	10 ⁷	10 ⁷	10 ⁷
Switching capacity of contacts	-	5 A	16 A	5 A
Output data size	1 Byte	1 Byte	1 Byte	1 Byte

Signal modules digital Digital output modules						
222-1BF00	222-1BF50	222-1BH30	222-1FF00	222-2BL10		
222-1BF10	222-1BH00	222-1BH50	222-1HD10	KSD222-1BH00		
222-1BF20	222-1BH10	222-1BH51	222-1HD20	KS222-1BH00		
222-1BF30	222-1BH20	222-1DB00	222-1HF00			

Order number	222-1FF00	222-1HD10	222-1HD20	222-1HF00
Status information, alarms, diagnostics				
Status display	green LED per channel	green LED per channel	none	green LED per channel
Interrupts	no	no	no	no
Process alarm	no	no	no	no
Diagnostic interrupt	no	no	no	no
Diagnostic functions	no	no	no	no
Diagnostics information read-out	none	none	none	none
Supply voltage display	none	none	none	none
Group error display	none	none	none	none
Channel error display	none	none	none	none
Isolation				
Between channels	-	✓	✓	-
Between channels of groups to	-	1	1	-
Between channels and backplane bus	✓	✓	✓	✓
Insulation tested with	DC 500 V	DC 500 V	DC 500 V	DC 500 V
Datasizes				
Input bytes	0	0	0	0
Output bytes	1	1	1	1
Parameter bytes	0	0	0	0
Diagnostic bytes	0	0	0	0
Housing				
Material	PPE / PA 6.6	PPE / PA 6.6	PPE / PA 6.6	PPE / PA 6.6
Mounting	Profile rail 35 mm	Profile rail 35 mm	Profile rail 35 mm	Profile rail 35 mm
Mechanical data				
Dimensions (WxHxD)	25.4 mm x 76 mm x 88 mm	25.4 mm x 76 mm x 88 mm	25.4 mm x 76 mm x 88 mm	25.4 mm x 76 mm x 88 mm
Weight	100 g	100 g	120 g	110 g
Environmental conditions				
Operating temperature	0 °C to 60 °C	0 °C to 60 °C	0 °C to 60 °C	0 °C to 60 °C
Storage temperature	-25 °C to 70 °C	-25 °C to 70 °C	-25 °C to 70 °C	-25 °C to 70 °C
Certifications				
UL508 certification	yes	yes	yes	yes

SLIO
100V
200V
300S
500S
HMI
Teleservice
StarterKits
Safety
Solutions
Software
Accessories
Appendix

Connections, Interfaces

Signal modules digital | Digital output modules

222-1BF00 222-1BF10 222-1BF20 222-1BF30	222-1BF50 222-1BH00 222-1BH10 222-1BH20	222-1BH30 222-1BH50 222-1BH51 222-1DB00	222-1FF00 222-1HD10 222-1HD20 222-1HF00	222-2BL10 KSD222-1BH00 KS222-1BH00		
--	--	--	--	--	--	--

222-1FF00

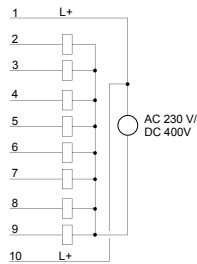

222-1HD10

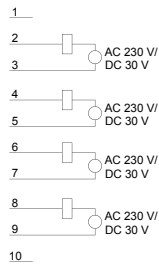

222-1HD20

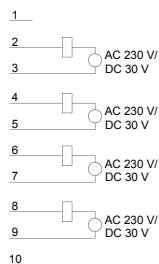

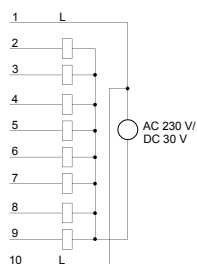

222-1HF00



Digital output modules

Signal modules digital | Digital output modules

222-1BF00 222-1BF10 222-1BF20 222-1BF30	222-1BF50 222-1BH00 222-1BH10 222-1BH20	222-1BH30 222-1BH50 222-1BH51 222-1DB00	222-1FF00 222-1HD10 222-1HD20 222-1HF00	222-2BL10 KSD222-1BH00 KS222-1BH00		
--	--	--	--	--	--	--

Order number	222-2BL10	KSD222-1BH00	KS222-1BH00	
Figure				
Type	SM 222	SM 222, Set	SM 222, Set	
General information				
Note	-	-	-	
Features	<ul style="list-style-type: none"> ▶ 32 outputs ▶ Output current 1 A 	<ul style="list-style-type: none"> ▶ 16 outputs ▶ LED status display on conversion module UB48D ▶ Output current 0.5 A 	<ul style="list-style-type: none"> ▶ 16 outputs ▶ LED status display on conversion module UB48 ▶ Output current 0.5 A 	
Current consumption/power loss				
Current consumption from backplane bus	180 mA	120 mA	120 mA	
Power loss	6.5 W	3.5 W	3.5 W	
Technical data digital outputs				
Number of outputs	32	16	16	
Cable length, shielded	1000 m	1000 m	1000 m	
Cable length, unshielded	600 m	600 m	600 m	
Rated load voltage	DC 20.4...28.8 V	DC 20.4...28.8 V	DC 20.4...28.8 V	
Current consumption from load voltage L+ (without load)	15 mA	10 mA	10 mA	
Total current per group, horizontal configuration, 40°C	10 A	8 A	8 A	
Total current per group, horizontal configuration, 60°C	10 A	8 A	8 A	
Total current per group, vertical configuration	10 A	8 A	8 A	
Output current at signal "1", rated value	1 A	0.5 A	0.5 A	
Output delay of "0" to "1"	150 µs	150 µs	150 µs	
Output delay of "1" to "0"	100 µs	100 µs	100 µs	
Minimum load current	-	-	-	
Lamp load	5 W	-	-	
Parallel switching of outputs for redundant control of a load	not possible	not possible	not possible	
Parallel switching of outputs for increased power	not possible	not possible	not possible	
Actuation of digital input	✓	✓	✓	
Switching frequency with resistive load	max. 1000 Hz	max. 1000 Hz	max. 1000 Hz	
Switching frequency with inductive load	max. 0.5 Hz	max. 0.5 Hz	max. 0.5 Hz	
Switching frequency on lamp load	max. 10 Hz	max. 10 Hz	max. 10 Hz	
Internal limitation of inductive shut-off voltage	L+ (-52 V)	L+ (-52 V)	L+ (-52 V)	
Short-circuit protection of output	yes, electronic	yes, electronic	yes, electronic	
Trigger level	1.5 A	1.5 A	1.5 A	
Number of operating cycle of relay outputs	-	-	-	
Switching capacity of contacts	-	-	-	
Output data size	4 Byte	2 Byte	2 Byte	

Signal modules digital Digital output modules						
222-1BF00	222-1BF50	222-1BH30	222-1FF00	222-2BL10		
222-1BF10	222-1BH00	222-1BH50	222-1HD10	KSD222-1BH00		
222-1BF20	222-1BH10	222-1BH51	222-1HD20	KS222-1BH00		
222-1BF30	222-1BH20	222-1DB00	222-1HF00			

Order number	222-2BL10	KSD222-1BH00	KS222-1BH00	
Status information, alarms, diagnostics				
Status display	green LED per channel	none	none	
Interrupts	no	no	no	
Process alarm	no	no	no	
Diagnostic interrupt	no	no	no	
Diagnostic functions	no	no	no	
Diagnostics information read-out	none	none	none	
Supply voltage display	green LED per group	none	none	
Group error display	red SF LED	none	none	
Channel error display	none	none	none	
Isolation				
Between channels	-	-	-	
Between channels of groups to	16	16	16	
Between channels and backplane bus	✓	✓	✓	
Insulation tested with	DC 500 V	DC 500 V	DC 500 V	
Datasizes				
Input bytes	0	0	0	
Output bytes	4	2	2	
Parameter bytes	0	0	0	
Diagnostic bytes	0	0	0	
Housing				
Material	PPE / PA 6.6	PPE / PA 6.6	PPE / PA 6.6	
Mounting	Profile rail 35 mm	Profile rail 35 mm	Profile rail 35 mm	
Mechanical data				
Dimensions (WxDxH)	50.8 mm x 76 mm x 88 mm	25.4 mm x 76 mm x 88 mm	25.4 mm x 76 mm x 88 mm	
Weight	150 g	80 g	80 g	
Environmental conditions				
Operating temperature	0 °C to 60 °C	0 °C to 60 °C	0 °C to 60 °C	
Storage temperature	-25 °C to 70 °C	-25 °C to 70 °C	-25 °C to 70 °C	
Certifications				
UL508 certification	yes	yes	yes	

Connections, Interfaces

Signal modules digital | Digital output modules

222-1BF00 222-1BF10 222-1BF20 222-1BF30	222-1BF50 222-1BH00 222-1BH10 222-1BH20	222-1BH30 222-1BH50 222-1BH51 222-1DB00	222-1FF00 222-1HD10 222-1HD20 222-1HF00	222-2BL10 KSD222-1BH00 KS222-1BH00		
--	--	--	--	--	--	--

222-2BL10

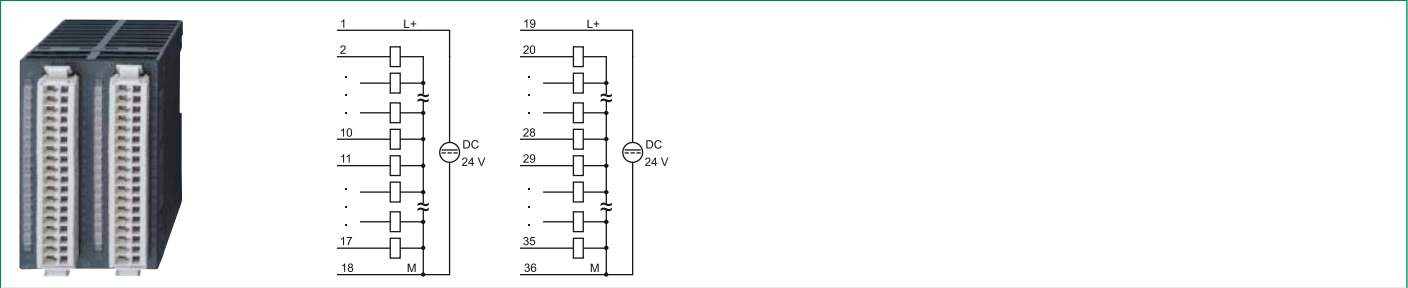

KSD222-1BH00

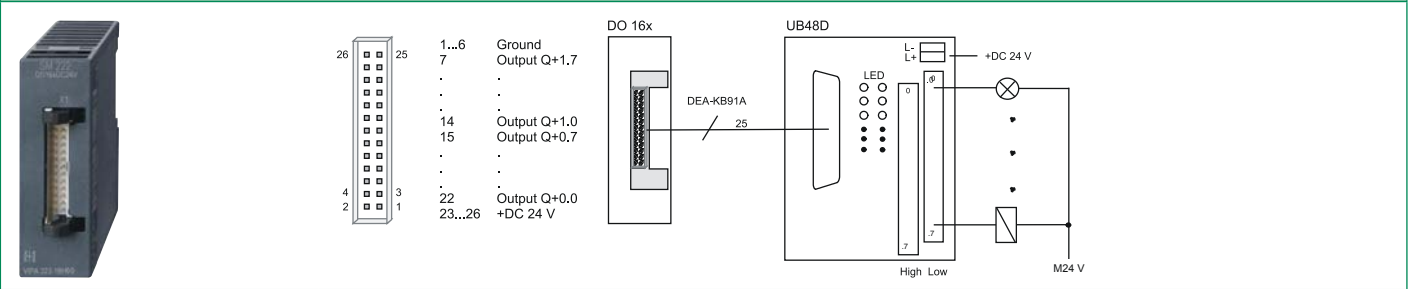

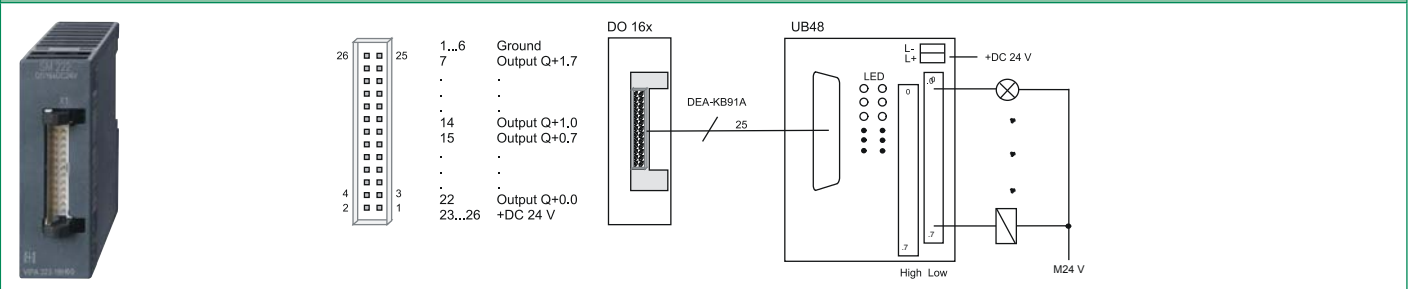

KS222-1BH00



Digital in/output modules

Signal modules digital | Digital in/output modules

223-1BF00
223-2BL10

Order number	223-1BF00	223-2BL10		
Figure				
Type	SM 223	SM 223		
General information				
Note	-	-		
Features	<ul style="list-style-type: none"> ▷ 8 channels (as input or output) ▷ Output current 1 A ▷ Diagnostics function 	<ul style="list-style-type: none"> ▷ 16 inputs/ 16 outputs ▷ DC 24 V ▷ Output current 1 A 		
Current consumption/power loss				
Current consumption from backplane bus	65 mA	120 mA		
Power loss	2 W	6.5 W		
Technical data digital inputs				
Number of inputs	8	16		
Cable length, shielded	1000 m	1000 m		
Cable length, unshielded	600 m	600 m		
Rated load voltage	-	-		
Current consumption from load voltage L+ (without load)	-	-		
Rated value	DC 20.4...28.8 V	DC 20.4...28.8 V		
Input voltage for signal "0"	DC 0...5 V	DC 0...5 V		
Input voltage for signal "1"	DC 15...28.8 V	DC 15...28.8 V		
Input voltage hysteresis	-	-		
Frequency range	-	-		
Input resistance	-	-		
Input current for signal "1"	7 mA	7 mA		
Connection of Two-Wire-BEROs possible	✓	✓		
Max. permissible BERO quiescent current	1.5 mA	1.5 mA		
Input delay of "0" to "1"	3 ms	3 ms		
Input delay of "1" to "0"	3 ms	3 ms		
Number of simultaneously utilizable inputs horizontal configuration	8	8		
Number of simultaneously utilizable inputs vertical configuration	8	8		
Input characteristic curve	IEC 61131-2, type 1	IEC 61131-2, type 1		
Initial data size	1 Byte	2 Byte		
Technical data digital outputs				
Number of outputs	8	16		
Cable length, shielded	1000 m	1000 m		
Cable length, unshielded	600 m	600 m		
Rated load voltage	DC 20.4...28.8 V	DC 20.4...28.8 V		
Reverse polarity protection of rated load voltage	-	-		

Signal modules digital Digital in/output modules						
223-1BF00 223-2BL10						

Order number	223-1BF00	223-2BL10		
Current consumption from load voltage L+ (without load)	10 mA	10 mA		
Output current at signal "1", rated value	1 A	1 A		
Output delay of "0" to "1"	150 µs	150 µs		
Output delay of "1" to "0"	100 µs	100 µs		
Minimum load current	-	-		
Lamp load	5 W	5 W		
Parallel switching of outputs for redundant control of a load	not possible	not possible		
Parallel switching of outputs for increased power	not possible	not possible		
Actuation of digital input	✓	✓		
Switching frequency with resistive load	max. 1000 Hz	max. 1000 Hz		
Switching frequency with inductive load	max. 0.5 Hz	max. 0.5 Hz		
Switching frequency on lamp load	max. 10 Hz	max. 10 Hz		
Internal limitation of inductive shut-off voltage	L+ (-52 V)	L+ (-52 V)		
Short-circuit protection of output	yes, electronic	yes, electronic		
Trigger level	1.7 A	1.7 A		
Number of operating cycle of relay outputs	-	-		
Switching capacity of contacts	-	-		
Output data size	1 Byte	2 Byte		
Status information, alarms, diagnostics				
Status display	green LED per channel	green LED per channel		
Interrupts	no	no		
Process alarm	no	no		
Diagnostic interrupt	no	no		
Diagnostic functions	no	no		
Diagnostics information read-out	none	none		
Supply voltage display	green LED	green LED		
Group error display	red SF LED	red SF LED		
Channel error display	none	none		
Isolation				
Between channels	-	-		
Between channels of groups to	8	16		
Between channels and backplane bus	✓	✓		
Insulation tested with	DC 500 V	DC 500 V		
Datasizes				
Input bytes	1	2		
Output bytes	1	2		
Parameter bytes	0	0		
Diagnostic bytes	0	0		

Signal modules digital Digital in/output modules						
223-1BF00 223-2BL10						

Order number	223-1BF00	223-2BL10		
Housing				
Material	PPE / PA 6.6	PPE / PA 6.6		
Mounting	Profile rail 35 mm	Profile rail 35 mm		
Mechanical data				
Dimensions (WxHxD)	25.4 mm x 76 mm x 88 mm	25.4 mm x 76 mm x 88 mm		
Weight	100 g	150 g		
Environmental conditions				
Operating temperature	0 °C to 60 °C	0 °C to 60 °C		
Storage temperature	-25 °C to 70 °C	-25 °C to 70 °C		
Certifications				
UL508 certification	yes	yes		

Connections, Interfaces

Signal modules digital | Digital in/output modules

223-1BF00
223-2BL10

223-1BF00

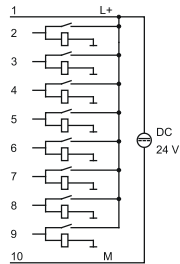

223-2BL10

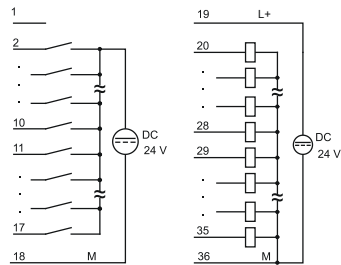

Signal modules analog



Structure and Function

Analog modules for connection of sensors and actuators are the interface of the PLC to the process. Analog input modules acquire the analog control signals from the process level and transform them into interpretable signals for the control. Analog output modules convert the internal control signals into signals suitable for the process level. There are analog modules with 4 to 8 channels available.

Characteristics

- › Large selection, 4 and 8 channel, available for various measurement encoders (U, I, TC, R)
- › Electrically isolated to the backplane bus
- › Compact design
- › LED Status Indicator
- › Maintenance-free cage-clamp technology
- › Label cards included
- › Front connector included
- › Assembly with 35 mm profile rail
- › 24 month warranty

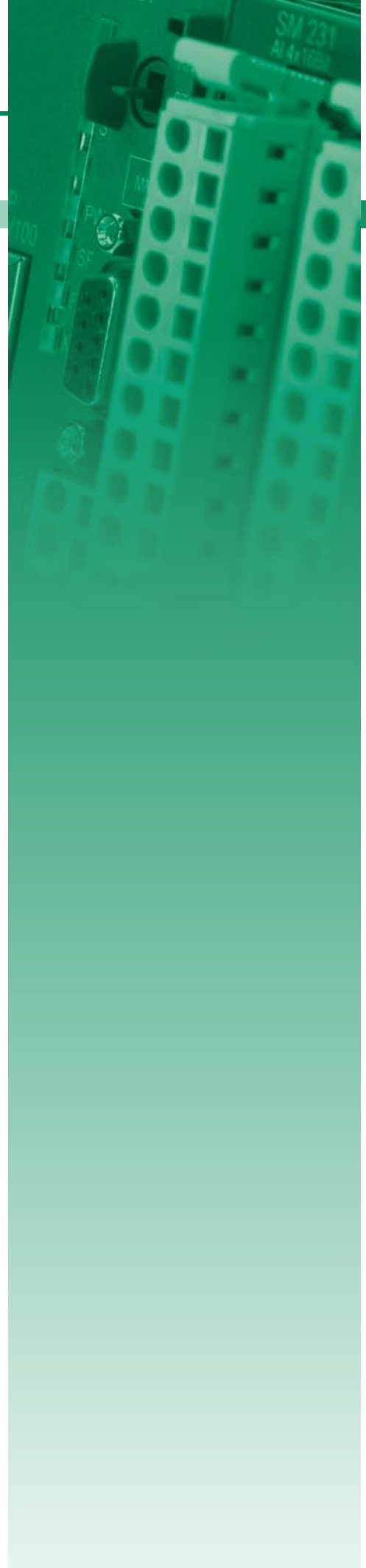





Overview

Order no.	Name/Description	Page
Analog input modules		
231-1BD30	SM 231 - Analog input ECO <ul style="list-style-type: none"> › 4 inputs › Configurable › Voltage +/-10 V 	346
231-1BD40	SM 231 - Analog input ECO <ul style="list-style-type: none"> › 4 inputs › Configurable › Current 4...20 mA, +/-20 mA 	346
231-1BD53	SM 231 - Analog input <ul style="list-style-type: none"> › 4 inputs › Configurable › Voltage, current › Resistance › Resistance thermometer, thermocouple 	346
231-1BD60	SM 231 - Analog input <ul style="list-style-type: none"> › 4 input 12 bit › Current 4...20 mA › Potential separated per channel 	346
231-1BD70	SM 231 - Analog input <ul style="list-style-type: none"> › 4 input 12 bit › Voltage +/-10 V › Potential separated per channel 	350
231-1BF00	SM 231 - Analog input <ul style="list-style-type: none"> › 8 inputs › Configurable › Voltage 0...60 mV › Resistance thermometer, thermocouple 	350
231-1FD00	SM 231 - Analog input FAST <ul style="list-style-type: none"> › 4 fast inputs › Configurable › Voltage, current › Cycle time 0.8 ms 	350
Analog output modules		
232-1BD30	SM 232 - Analog output ECO <ul style="list-style-type: none"> › 4 outputs › Configurable › Voltage +/-10 V, 0..10 V 	354
232-1BD40	SM 232 - Analog output ECO <ul style="list-style-type: none"> › 4 outputs › Configurable › Current 0(4)...20mA 	354
232-1BD51	SM 232 - Analog output <ul style="list-style-type: none"> › 4 outputs › Configurable › Voltage, current 	354
Analog in/output modules		
234-1BD50	SM 234 - Analog in-/output <ul style="list-style-type: none"> › 2 inputs/2 outputs › Configurable › Voltage, current 	358
234-1BD60	SM 234 - Analog in-/output <ul style="list-style-type: none"> › 4 inputs/2 outputs › Configurable › Voltage, current › Resistance, resistance thermometer 	358
Combination modules		
238-2BC00	SM 238C - Digital in-/output, counter, analog in-/output <ul style="list-style-type: none"> › 16 (12) digital inputs › 0 (4) digital outputs › max. 3 counter › 4 analog inputs › 2 analog outputs 	363

Analog input modules

Signal modules analog Analog input modules					
231-1BD30	231-1BD70				
231-1BD40	231-1BF00				
231-1BD53	231-1FD00				
231-1BD60					

Order number	231-1BD30	231-1BD40	231-1BD53	231-1BD60
Figure				
Type	SM 231, ECO	SM 231, ECO	SM 231	SM 231
General information				
Note	-	-	-	-
Features	<ul style="list-style-type: none"> ▶ 4 inputs ▶ Configurable ▶ Voltage +/-10 V 	<ul style="list-style-type: none"> ▶ 4 inputs ▶ Configurable ▶ Current 4...20 mA, +/-20 mA 	<ul style="list-style-type: none"> ▶ 4 inputs ▶ Configurable ▶ Voltage, current ▶ Resistance ▶ Resistance thermo-meter, thermocouple 	<ul style="list-style-type: none"> ▶ 4 input 12 bit ▶ Current 4...20 mA ▶ Potential separated per channel
Current consumption/power loss				
Current consumption from backplane bus	120 mA	120 mA	280 mA	280 mA
Power loss	0.6 W	0.6 W	1.4 W	1.4 W
Technical data analog inputs				
Number of inputs	4	4	4	4
Cable length, shielded	200 m	200 m	200 m	200 m
Rated load voltage	-	-	-	-
Current consumption from load voltage L+ (without load)	-	-	-	-
Voltage inputs	✓	-	✓	-
Min. input resistance (voltage range)	100 kΩ	-	20 MΩ	-
Input voltage ranges	-10 V ... +10 V	-	-50 mV ... +50 mV -400 mV ... +400 mV -4 V ... +4 V -10 V ... +10 V	-
Operational limit of voltage ranges	+/-0.2%	-	+/-0.3% ... +/-0.6%	-
Operational limit of voltage ranges with SFU	-	-	-	-
Basic error limit voltage ranges	+/-0.1%	-	+/-0.2% ... +/-0.4%	-
Basic error limit voltage ranges with SFU	-	-	-	-
Destruction limit current	-	-	-	-
Current inputs	-	✓	✓	✓
Max. input resistance (current range)	-	110 Ω	85 Ω	20 Ω
Input current ranges	-	-20 mA ... +20 mA +4 mA ... +20 mA	-20 mA ... +20 mA 0 mA ... +20 mA +4 mA ... +20 mA	+4 mA ... +20 mA
Operational limit of current ranges	-	+/-0.2% ... +/-0.5%	+/-0.3% ... +/-0.8%	-
Operational limit of current ranges with SFU	-	-	-	-
Radical error limit current ranges with SFU	-	+/-0.1% ... +/-0.2%	+/-0.2% ... +/-0.5%	-
Radical error limit current ranges with SFU	-	-	-	-
Destruction limit current inputs (electrical current)	-	-	-	-
Destruction limit current inputs (voltage)	-	-	-	-
Resistance inputs	-	-	✓	-

Signal modules analog Analog input modules					
231-1BD30	231-1BD70				
231-1BD40	231-1BF00				
231-1BD53	231-1FD00				
231-1BD60					

Order number	231-1BD30	231-1BD40	231-1BD53	231-1BD60
Resistance ranges	-	-	0 ... 60 Ohm 0 ... 600 Ohm 0 ... 3000 Ohm 0 ... 6000 Ohm	-
Operational limit of resistor ranges	-	-	+/-0.4% ... +/-0.8%	-
Operational limit of resistor ranges with SFU	-	-	-	-
Basic error limit	-	-	+/-0.2% ... +/-0.4%	-
Basic error limit with SFU	-	-	-	-
Destruction limit resistance inputs	-	-	-	-
Resistance thermometer inputs	-	-	✓	-
Resistance thermometer ranges	-	-	Pt100, Pt1000 KTY81-152 Ni100, Ni1000 Cu50 KTY81-110 KTY81-120 KTY81-121 KTY81-122 KTY81-150 KTY81-151	-
Operational limit of resistance thermometer ranges	-	-	+/-0.4% ... +/-1.4%	-
Operational limit of resistance thermometer ranges with SFU	-	-	-	-
Basic error limit thermoresistor ranges	-	-	+/-0.2% ... +/-0.7%	-
Basic error limit thermoresistor ranges with SFU	-	-	-	-
Destruction limit resistance thermometer inputs	-	-	-	-
Thermocouple inputs	-	-	✓	-
Thermocouple ranges	-	-	type J type K type N type R type S type E type T	-
Operational limit of thermocouple ranges	-	-	+/-1.5%	-
Operational limit of thermocouple ranges with SFU	-	-	-	-
Basic error limit thermoelement ranges	-	-	+/-1.0%	-
Basic error limit thermoelement ranges with SFU	-	-	-	-
Destruction limit thermocouple inputs	-	-	-	-
Programmable temperature compensation	-	-	✓	-
External temperature compensation	-	-	✓	-
Internal temperature compensation	-	-	✓	-
Internal temperature compensation	-	-	5 K	-
Technical unit of temperature measurement	-	-	-	-
Resolution in bit	13	13	16	12
Measurement principle	successive approximation	successive approximation	Sigma-Delta	successive approximation

- SLIO
- 100V
- 200V
- 300S
- 500S
- HMI
- Teleservice
- StarterKits
- Safety
- Solutions
- Software
- Accessories
- Appendix

Signal modules analog Analog input modules					
231-1BD30	231-1BD70				
231-1BD40	231-1BF00				
231-1BD53	231-1FD00				
231-1BD60					

Order number	231-1BD30	231-1BD40	231-1BD53	231-1BD60
Basic conversion time	2 ms / channel	2 ms / channel	7 ms ... 272 ms	-
Noise suppression for frequency	f=50 Hz...400 Hz	f=50 Hz...400 Hz	none	-
Initial data size	8 Byte	8 Byte	8 Byte	8 Byte
Status information, alarms, diagnostics				
Status display	none	none	none	none
Interrupts	no	no	yes	no
Process alarm	no	no	no	no
Diagnostic interrupt	no	no	yes, parameterizable	no
Diagnostic functions	no	no	yes	no
Diagnostics information read-out	none	none	possible	none
Supply voltage display	none	none	none	none
Group error display	red SF LED	red SF LED	none	none
Channel error display	none	none	red LED per channel	red LED per channel
Isolation				
Between channels	-	-	-	✓
Between channels of groups to	-	-	-	1
Between channels and backplane bus	✓	✓	✓	✓
Between channels and power supply	-	-	-	✓
Max. potential difference between circuits	-	-	-	DC 75 V/ AC 60 V
Max. potential difference between inputs (Ucm)	DC 2 V	DC 2 V	DC 4 V	DC 75 V/ AC 60 V
Max. potential difference between Mana and Mintern (Uiso)	-	-	-	DC 75 V/ AC 60 V
Max. potential difference between inputs and Mana (Ucm)	-	-	-	-
Max. potential difference between inputs and Mintern (Uiso)	DC 75 V/ AC 60 V	DC 75 V/ AC 60 V	DC 75 V/ AC 60 V	DC 75 V/ AC 60 V
Max. potential difference between Mintern and outputs	-	-	-	-
Insulation tested with	DC 500 V	DC 500 V	DC 500 V	DC 500 V
Datasizes				
Input bytes	8	8	8	8
Output bytes	0	0	0	0
Parameter bytes	12	12	12	3
Diagnostic bytes	0	0	12	0
Housing				
Material	PPE / PA 6.6	PPE / PA 6.6	PPE / PA 6.6	PPE / PA 6.6
Mounting	Profile rail 35 mm	Profile rail 35 mm	Profile rail 35 mm	Profile rail 35 mm
Mechanical data				
Dimensions (WxHxD)	25.4 mm x 76 mm x 88 mm	25.4 mm x 76 mm x 88 mm	25.4 mm x 76 mm x 88 mm	25.4 mm x 76 mm x 88 mm
Weight	90 g	90 g	100 g	90 g
Environmental conditions				
Operating temperature	0 °C to 60 °C	0 °C to 60 °C	0 °C to 60 °C	0 °C to 60 °C
Storage temperature	-25 °C to 70 °C	-25 °C to 70 °C	-25 °C to 70 °C	-25 °C to 70 °C
Certifications				
UL508 certification	yes	yes	yes	yes

Connections, Interfaces

Signal modules analog | Analog input modules

231-1BD30	231-1BD70				
231-1BD40	231-1BF00				
231-1BD53	231-1FD00				
231-1BD60					

231-1BD30

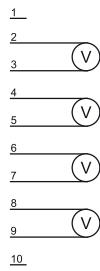

231-1BD40

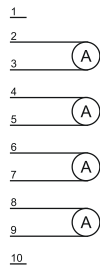

231-1BD53

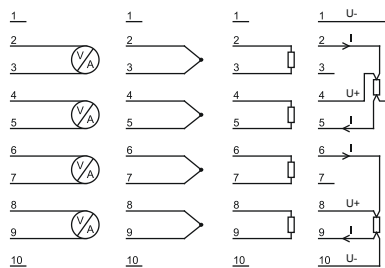

231-1BD60

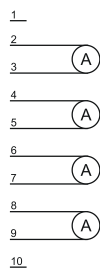



Analog input modules

Signal modules analog | Analog input modules

231-1BD30
231-1BD40
231-1BD53
231-1BD60

231-1BD70
231-1BF00
231-1FD00

Order number	231-1BD70	231-1BF00	231-1FD00	
Figure				
Type	SM 231	SM 231	SM 231	
General information				
Note	-	-	-	
Features	<ul style="list-style-type: none"> ▸ 4 input 12 bit ▸ Voltage +/-10 V ▸ Potential separated per channel 	<ul style="list-style-type: none"> ▸ 8 inputs ▸ Configurable ▸ Voltage 0...60 mV ▸ Resistance thermometer, thermocouple 	<ul style="list-style-type: none"> ▸ 4 fast inputs ▸ Configurable ▸ Voltage, current ▸ Cycle time 0.8 ms 	
Current consumption/power loss				
Current consumption from backplane bus	280 mA	280 mA	300 mA	
Power loss	1.4 W	1.4 W	1.5 W	
Technical data analog inputs				
Number of inputs	4	8	4	
Cable length, shielded	200 m	200 m	200 m	
Rated load voltage	-	-	-	
Current consumption from load voltage L+ (without load)	-	-	-	
Voltage inputs	✓	✓	✓	
Min. input resistance (voltage range)	83 kΩ	2 MΩ	10 MΩ	
Input voltage ranges	-10 V ... +10 V	0 mV ... +60 mV	-400 mV ... +400 mV -4 V ... +4 V -10 V ... +10 V	
Operational limit of voltage ranges	-	-	+/-0.2% ... +/-0.4%	
Operational limit of voltage ranges with SFU	-	-	-	
Basic error limit voltage ranges	-	+/-0.1%	+/-0.1% ... +/-0.3%	
Basic error limit voltage ranges with SFU	-	-	-	
Destruction limit current	-	-	-	
Current inputs	-	-	✓	
Max. input resistance (current range)	-	-	57 Ω	
Input current ranges	-	-	+4 mA ... +20 mA -20 mA ... +20 mA	
Operational limit of current ranges	-	-	+/-0.2% ... +/-0.5%	
Operational limit of current ranges with SFU	-	-	-	
Radical error limit current ranges with SFU	-	-	+/-0.1% ... +/-0.3%	
Radical error limit current ranges with SFU	-	-	-	
Destruction limit current inputs (electrical current)	-	-	-	
Destruction limit current inputs (voltage)	-	-	-	
Resistance inputs	-	-	-	
Resistance ranges	-	-	-	
Operational limit of resistor ranges	-	-	-	
Operational limit of resistor ranges with SFU	-	-	-	

Signal modules analog Analog input modules					
231-1BD30	231-1BD70				
231-1BD40	231-1BF00				
231-1BD53	231-1FD00				
231-1BD60					

Order number	231-1BD70	231-1BF00	231-1FD00	
Basic error limit	-	-	-	
Basic error limit with SFU	-	-	-	
Destruction limit resistance inputs	-	-	-	
Resistance thermometer inputs	-	✓	-	
Resistance thermometer ranges	-	Pt100	-	
Operational limit of resistance thermometer ranges	-	-	-	
Operational limit of resistance thermometer ranges with SFU	-	-	-	
Basic error limit thermoresistor ranges	-	±0.15% (2-wire) ±0.15% (4-wire)	-	
Basic error limit thermoresistor ranges with SFU	-	-	-	
Destruction limit resistance thermometer inputs	-	-	-	
Thermocouple inputs	-	✓	-	
Thermocouple ranges	-	type J type K type T	-	
Operational limit of thermocouple ranges	-	-	-	
Operational limit of thermocouple ranges with SFU	-	-	-	
Basic error limit thermoelement ranges	-	±0.1% (Compensation external) ±1.0% (internal)	-	
Basic error limit thermoelement ranges with SFU	-	-	-	
Destruction limit thermocouple inputs	-	-	-	
Programmable temperature compensation	-	✓	-	
External temperature compensation	-	✓	-	
Internal temperature compensation	-	✓	-	
Internal temperature compensation	-	4 K	-	
Technical unit of temperature measurement	-	-	-	
Resolution in bit	12	16	16	
Measurement principle	successive approximation	Sigma-Delta	successive approximation	
Basic conversion time	-	6.75 ms ... 268 ms	0.2 ms/channel	
Noise suppression for frequency	-	50 Hz and 60 Hz	-	
Initial data size	8 Byte	16 Byte	8 Byte	
Status information, alarms, diagnostics				
Status display	none	none	none	
Interrupts	no	yes	yes	
Process alarm	no	no	yes, parameterizable	
Diagnostic interrupt	no	yes, parameterizable	yes, parameterizable	
Diagnostic functions	no	yes	yes	
Diagnostics information read-out	none	possible	possible	
Supply voltage display	none	none	none	
Group error display	none	red SF LED	none	
Channel error display	none	red LED per channel	red LED per channel	

Signal modules analog Analog input modules					
231-1BD30	231-1BD70				
231-1BD40	231-1BF00				
231-1BD53	231-1FD00				
231-1BD60					

Order number	231-1BD70	231-1BF00	231-1FD00	
Isolation				
Between channels	✓	-	-	
Between channels of groups to	1	-	-	
Between channels and backplane bus	✓	✓	✓	
Between channels and power supply	✓	-	-	
Max. potential difference between circuits	DC 75 V/ AC 60 V	-	-	
Max. potential difference between inputs (Ucm)	DC 75 V/ AC 60 V	DC 15 V	DC 2 V	
Max. potential difference between Mana and Mintern (Uiso)	DC 75 V/ AC 60 V	-	-	
Max. potential difference between inputs and Mana (Ucm)	-	-	-	
Max. potential difference between inputs and Mintern (Uiso)	DC 75 V/ AC 60 V	DC 75 V/ AC 15 V	DC 75 V/ AC 60 V	
Max. potential difference between Mintern and outputs	-	-	-	
Insulation tested with	DC 500 V	DC 500 V	DC 500 V	
Datasizes				
Input bytes	8	16	8	
Output bytes	0	0	0	
Parameter bytes	3	12	34	
Diagnostic bytes	0	12	12	
Housing				
Material	PPE / PA 6.6	PPE / PA 6.6	PPE / PA 6.6	
Mounting	Profile rail 35 mm	Profile rail 35 mm	Profile rail 35 mm	
Mechanical data				
Dimensions (WxHxD)	25.4 mm x 76 mm x 88 mm	25.4 mm x 76 mm x 88 mm	25.4 mm x 76 mm x 88 mm	
Weight	90 g	90 g	90 g	
Environmental conditions				
Operating temperature	0 °C to 60 °C	0 °C to 60 °C	0 °C to 60 °C	
Storage temperature	-25 °C to 70 °C	-25 °C to 70 °C	-25 °C to 70 °C	
Certifications				
UL508 certification	yes	yes	yes	

Connections, Interfaces

Signal modules analog | Analog input modules

231-1BD30 231-1BD40 231-1BD53 231-1BD60	231-1BD70 231-1BF00 231-1FD00				
--	-------------------------------------	--	--	--	--

231-1BD70

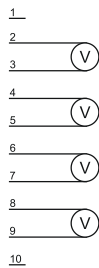

231-1BF00

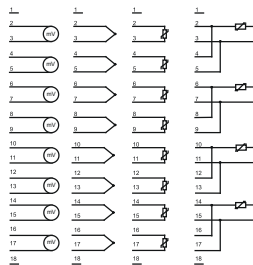

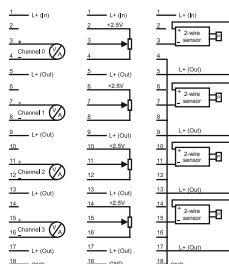

231-1FD00



Analog output modules

Signal modules analog Analog output modules					
232-1BD30					
232-1BD40					
232-1BD51					

Order number	232-1BD30	232-1BD40	232-1BD51	
Figure				
Type	SM 232, ECO	SM 232, ECO	SM 232	
General information				
Note	-	-	-	
Features	<ul style="list-style-type: none"> ▸ 4 outputs ▸ Configurable ▸ Voltage +/-10 V, 0...10 V 	<ul style="list-style-type: none"> ▸ 4 outputs ▸ Configurable ▸ Current 0(4)...20mA 	<ul style="list-style-type: none"> ▸ 4 outputs ▸ Configurable ▸ Voltage, current 	
Current consumption/power loss				
Current consumption from backplane bus	60 mA	60 mA	75 mA	
Power loss	2.7 W	1.5 W	1.8 W	
Technical data analog outputs				
Number of outputs	4	4	4	
Cable length, shielded	200 m	200 m	200 m	
Rated load voltage	DC 24 V	DC 24 V	DC 24 V	
Reverse polarity protection of rated load voltage	✓	✓	✓	
Current consumption from load voltage L+ (without load)	100 mA	50 mA	60 mA	
Voltage output short-circuit protection	✓	-	✓	
Voltage outputs	✓	-	✓	
Min. load resistance (voltage range)	5 kΩ	-	1 kΩ	
Max. capacitive load (current range)	1 μF	-	1 μF	
Max. inductive load (current range)	7 mA	-	30 mA	
Output voltage ranges	-10 V ... +10 V 0 V ... +10 V	-	-10 V ... +10 V +1 V ... +5 V 0 V ... +10 V	
Operational limit of voltage ranges	+/-0.4%	-	+/-0.4% ... +/-0.8%	
Basic error limit voltage ranges	+/-0.2%	-	+/-0.2% ... +/-0.4%	
Destruction limit against external applied voltage	-	-	-	
Current outputs	-	✓	✓	
Max. in load resistance (current range)	-	350 Ω	500 Ω	
Max. inductive load (current range)	-	10 mH	10 mH	
Max. inductive load (current range)	-	13 V	12 V	
Output current ranges	-	0 mA ... +20 mA +4 mA ... +20 mA	0 mA ... +20 mA +4 mA ... +20 mA -20 mA ... +20 mA	
Operational limit of current ranges	-	+/-0.4%	+/-0.3% ... +/-0.8%	
Basic error limit current ranges	-	+/-0.2%	+/-0.2% ... +/-0.5%	

Signal modules analog | Analog output modules

232-1BD30					
232-1BD40					
232-1BD51					

Order number	232-1BD30	232-1BD40	232-1BD51	
Destruction limit against external applied voltage	-	-	-	
Settling time for ohmic load	1.5 ms	0.03 ms	0.05 ms	
Settling time for capacitive load	3 ms	-	0.5 ms	
Settling time for inductive load	-	1.5 ms	0.1 ms	
Resolution in bit	12	12	12	
Conversion time	0.7 ms / all channels	0.7 ms / all channels	0.45 ms / channel	
Substitute value can be applied	no	no	no	
Output data size	8 Byte	8 Byte	8 Byte	
Status information, alarms, diagnostics				
Status display	none	none	none	
Interrupts	no	no	yes	
Process alarm	no	no	no	
Diagnostic interrupt	no	no	yes, parameterizable	
Diagnostic functions	no	no	yes	
Diagnostics information read-out	none	none	possible	
Supply voltage display	green LED	green LED	none	
Group error display	none	none	red SF LED	
Channel error display	none	none	none	
Isolation				
Between channels	-	-	-	
Between channels of groups to	-	-	-	
Between channels and backplane bus	✓	✓	✓	
Between channels and power supply	✓	✓	✓	
Max. potential difference between circuits	-	-	-	
Max. potential difference between inputs (Ucm)	-	-	-	
Max. potential difference between Mana and Mintern (Uiso)	DC 75 V/ AC 60 V	DC 75 V/ AC 60 V	DC 75 V/ AC 60 V	
Max. potential difference between inputs and Mana (Ucm)	-	-	-	
Max. potential difference between inputs and Mintern (Uiso)	-	-	-	
Max. potential difference between Mintern and outputs	-	-	-	
Insulation tested with	DC 500 V	DC 500 V	DC 500 V	
Datasizes				
Input bytes	0	0	0	
Output bytes	8	8	8	
Parameter bytes	8	8	8	
Diagnostic bytes	0	0	4	

SLIO
100V
200V
300S
500S
HMI
Teleservice
StarterKits
Safety
Solutions
Software
Accessories
Appendix

Signal modules analog Analog output modules					
232-1BD30					
232-1BD40					
232-1BD51					

Order number	232-1BD30	232-1BD40	232-1BD51	
Housing				
Material	PPE / PA 6.6	PPE / PA 6.6	PPE / PA 6.6	
Mounting	Profile rail 35 mm	Profile rail 35 mm	Profile rail 35 mm	
Mechanical data				
Dimensions (WxHxD)	25.4 mm x 76 mm x 88 mm	25.4 mm x 76 mm x 88 mm	25.4 mm x 76 mm x 88 mm	
Weight	80 g	80 g	100 g	
Environmental conditions				
Operating temperature	0 °C to 60 °C	0 °C to 60 °C	0 °C to 60 °C	
Storage temperature	-25 °C to 70 °C	-25 °C to 70 °C	-25 °C to 70 °C	
Certifications				
UL508 certification	yes	yes	yes	

Connections, Interfaces

Signal modules analog | Analog output modules

232-1BD30
232-1BD40
232-1BD51

232-1BD30

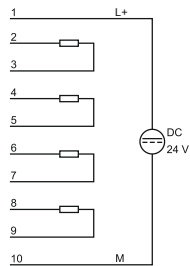

232-1BD40

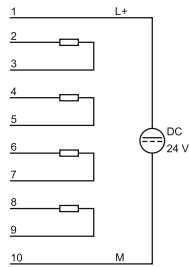

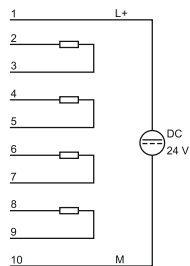

232-1BD51



Analog in/output modules

Signal modules analog | Analog in/output modules

234-1BD50
234-1BD60

Order number	234-1BD50	234-1BD60		
Figure				
Type	SM 234	SM 234		
General information				
Note	-	-		
Features	<ul style="list-style-type: none"> › 2 inputs/2 outputs › Configurable › Voltage, current 	<ul style="list-style-type: none"> › 4 inputs/2 outputs › Configurable › Voltage, current › Resistance, resistance thermometer 		
Current consumption/power loss				
Current consumption from backplane bus	100 mA	100 mA		
Power loss	2.9 W	2.9 W		
Technical data analog inputs				
Number of inputs	2	4		
Cable length, shielded	200 m	200 m		
Rated load voltage	DC 24 V	DC 24 V		
Reverse polarity protection of rated load voltage	✓	✓		
Current consumption from load voltage L+ (without load)	70 mA	70 mA		
Voltage inputs	✓	✓		
Min. input resistance (voltage range)	100 kΩ	120 kΩ		
Input voltage ranges	+1 V ... +5 V 0 V ... +10 V -10 V ... +10 V	+1 V ... +5 V 0 V ... +10 V -10 V ... +10 V -400 mV ... +400 mV -4 V ... +4 V		
Operational limit of voltage ranges	-	+/-0.3% ... +/-0.7%		
Operational limit of voltage ranges with SFU	-	-		
Basic error limit voltage ranges	+/-0.2% ... +/-0.6%	+/-0.2% ... +/-0.5%		
Basic error limit voltage ranges with SFU	-	-		
Destruction limit current	-	-		
Current inputs	✓	✓		
Max. input resistance (current range)	50 Ω	90 Ω		
Input current ranges	+4 mA ... +20 mA 0 mA ... +20 mA -20 mA ... +20 mA	+4 mA ... +20 mA 0 mA ... +20 mA -20 mA ... +20 mA		
Operational limit of current ranges	-	+/-0.3% ... +/-0.8%		
Operational limit of current ranges with SFU	-	-		
Basic error limit current ranges	+/-0.3% ... +/-0.8%	+/-0.2% ... +/-0.5%		
Radical error limit current ranges with SFU	-	-		
Destruction limit current inputs (electrical current)	-	-		

Signal modules analog Analog in/output modules						
234-1BD50						
234-1BD60						

Order number	234-1BD50	234-1BD60		
Destruction limit current inputs (voltage)	-	-		
Resistance inputs	-	✓		
Resistance ranges	-	0 ... 600 Ohm 0 ... 3000 Ohm		
Operational limit of resistor ranges	-	+/-0.4%		
Operational limit of resistor ranges with SFU	-	-		
Basic error limit	-	+/-0.2%		
Basic error limit with SFU	-	-		
Destruction limit resistance inputs	-	-		
Resistance thermometer inputs	-	✓		
Resistance thermometer ranges	-	Pt100 Pt1000 Ni100 Ni1000		
Operational limit of resistance thermometer ranges	-	+/-0.4% ... +/-1.0%		
Operational limit of resistance thermometer ranges with SFU	-	-		
Basic error limit thermoresistor ranges	-	+/-0.2% ... +/-0.5%		
Basic error limit thermoresistor ranges with SFU	-	-		
Destruction limit resistance thermometer inputs	-	-		
Thermocouple inputs	-	-		
Thermocouple ranges	-	-		
Operational limit of thermocouple ranges	-	-		
Operational limit of thermocouple ranges with SFU	-	-		
Basic error limit thermoelement ranges	-	-		
Basic error limit thermoelement ranges with SFU	-	-		
Destruction limit thermocouple inputs	-	-		
Programmable temperature compensation	-	-		
External temperature compensation	-	-		
Internal temperature compensation	-	-		
Internal temperature compensation	-	-		
Technical unit of temperature measurement	-	-		
Resolution in bit	16	16		
Measurement principle	Sigma-Delta	Sigma-Delta		
Basic conversion time	6.75 ms - 268 ms	7 ms - 272 ms		
Noise suppression for frequency	50 Hz and 60 Hz	50 Hz and 60 Hz		
Initial data size	4 Byte	4 Byte		

SLIO
100V
200V
300S
500S
HMI
Teleservice
StarterKits
Safety
Solutions
Software
Accessories
Appendix

Signal modules analog Analog in/output modules					
234-1BD50					
234-1BD60					

Order number	234-1BD50	234-1BD60		
Technical data analog outputs				
Number of outputs	2	2		
Cable length, shielded	200 m	200 m		
Rated load voltage	DC 24 V	DC 24 V		
Reverse polarity protection of rated load voltage	✓	✓		
Current consumption from load voltage L+ (without load)	70 mA	70 mA		
Voltage output short-circuit protection	✓	✓		
Voltage outputs	✓	✓		
Min. load resistance (voltage range)	1 kΩ	1 kΩ		
Max. capacitive load (current range)	1 μF	1 μF		
Max. inductive load (current range)	30 mA	30 mA		
Output voltage ranges	-10 V ... +10 V +1 V ... +5 V 0 V ... +10 V	-10 V ... +10 V +1 V ... +5 V 0 V ... +10 V		
Operational limit of voltage ranges	-	+/-0.4% ... +/-0.8%		
Basic error limit voltage ranges	+/-0.2% ... +/-0.6%	+/-0.2% ... +/-0.4%		
Destruction limit against external applied voltage	-	-		
Current outputs	✓	✓		
Max. in load resistance (current range)	500 Ω	500 Ω		
Max. inductive load (current range)	10 mH	10 mH		
Max. inductive load (current range)	14 V	13 V		
Output current ranges	-20 mA ... +20 mA +4 mA ... +20 mA 0 mA ... +20 mA	-20 mA ... +20 mA +4 mA ... +20 mA 0 mA ... +20 mA		
Operational limit of current ranges	-	+/-0.3% ... +/-0.8%		
Basic error limit current ranges	+/-0.3% ... +/-0.8%	+/-0.2% ... +/-0.5%		
Destruction limit against external applied voltage	-	-		
Settling time for ohmic load	0.05 ms	0.3 ms		
Settling time for capacitive load	0.5 ms	1 ms		
Settling time for inductive load	0.1 ms	0.5 ms		
Resolution in bit	12	12		
Conversion time	2.5 ms/all channels	1.5 ms/channel		
Substitute value can be applied	yes	yes		
Output data size	4 Byte	4 Byte		
Status information, alarms, diagnostics				
Status display	none	none		
Interrupts	yes	yes		
Process alarm	no	no		
Diagnostic interrupt	yes, parameterizable	yes, parameterizable		
Diagnostic functions	yes	yes		
Diagnostics information read-out	possible	possible		
Supply voltage display	green LED	none		
Group error display	red SF LED	red SF LED		
Channel error display	none	none		

Signal modules analog Analog in/output modules					
234-1BD50					
234-1BD60					

Order number	234-1BD50	234-1BD60		
Isolation				
Between channels	-	-		
Between channels of groups to	-	-		
Between channels and backplane bus	✓	✓		
Between channels and power supply	✓	✓		
Max. potential difference between circuits	-	-		
Max. potential difference between inputs (Ucm)	-	DC 4 V		
Max. potential difference between Mana and Mintern (Uiso)	DC 75 V/ AC 60 V	-		
Max. potential difference between inputs and Mana (Ucm)	-	-		
Max. potential difference between inputs and Mintern (Uiso)	-	DC 75 V/ AC 60 V		
Max. potential difference between Mintern and outputs	-	-		
Insulation tested with	DC 500 V	DC 500 V		
Datasizes				
Input bytes	4	8		
Output bytes	4	4		
Parameter bytes	14	18		
Diagnostic bytes	12	12		
Housing				
Material	PPE / PA 6.6	PPE / PA 6.6		
Mounting	Profile rail 35 mm	Profile rail 35 mm		
Mechanical data				
Dimensions (WxHxD)	25.4 mm x 76 mm x 88 mm	25.4 mm x 76 mm x 88 mm		
Weight	110 g	100 g		
Environmental conditions				
Operating temperature	0 °C to 60 °C	0 °C to 60 °C		
Storage temperature	-25 °C to 70 °C	-25 °C to 70 °C		
Certifications				
UL508 certification	yes	yes		

Connections, Interfaces

Signal modules analog | Analog in/output modules

234-1BD50
234-1BD60

--	--	--	--	--	--	--

234-1BD50

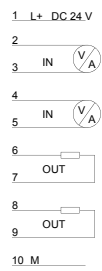

234-1BD60

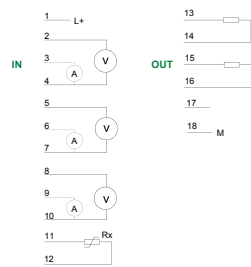

Combination modules

Signal modules analog Combination modules					
238-2BC00					

Order number	238-2BC00			
Figure				
Type	SM 238C, Digital In-/Output, Counter, Analog In-/Output			
General information				
Note	-			
Features	<ul style="list-style-type: none"> ▶ 16 (12) digital inputs ▶ 0 (4) digital outputs ▶ max. 3 counter ▶ 4 analog inputs ▶ 2 analog outputs 			
Current consumption/power loss				
Current consumption from backplane bus	280 mA			
Power loss	5.5 W			
Technical data digital inputs				
Number of inputs	16			
Cable length, shielded	1000 m			
Cable length, unshielded	600 m			
Rated load voltage	-			
Current consumption from load voltage L+ (without load)	-			
Rated value	DC 20.4...28.8 V			
Input voltage for signal "0"	DC 0...5 V			
Input voltage for signal "1"	DC 15...28.8 V			
Input voltage hysteresis	-			
Frequency range	-			
Input resistance	-			
Input current for signal "1"	7 mA			
Connection of Two-Wire-BEROs possible	✓			
Max. permissible BERO quiescent current	1.5 mA			
Input delay of "0" to "1"	3 ms			
Input delay of "1" to "0"	3 ms			
Number of simultaneously utilizable inputs horizontal configuration	16			
Number of simultaneously utilizable inputs vertical configuration	16			
Input characteristic curve	IEC 61131-2, type 1			
Initial data size	16 Byte			

Signal modules analog Combination modules					
238-2BC00					

Order number	238-2BC00			
Technical data digital outputs				
Number of outputs	4			
Cable length, shielded	1000 m			
Cable length, unshielded	600 m			
Rated load voltage	DC 20.4...28.8 V			
Reverse polarity protection of rated load voltage	-			
Current consumption from load voltage L+ (without load)	20 mA			
Total current per group, horizontal configuration, 40°C	4 A			
Total current per group, horizontal configuration, 60°C	2 A			
Total current per group, vertical configuration	4 A			
Output voltage signal "1" at min. current	L+ (-125 mV)			
Output voltage signal "1" at max. current	L+ (-0.8 V)			
Output current at signal "1", rated value	1 A			
Output delay of "0" to "1"	150 µs			
Output delay of "1" to "0"	100 µs			
Minimum load current	-			
Lamp load	5 W			
Parallel switching of outputs for redundant control of a load	not possible			
Parallel switching of outputs for increased power	not possible			
Actuation of digital input	✓			
Switching frequency with resistive load	max. 1000 Hz			
Switching frequency with inductive load	max. 0.5 Hz			
Switching frequency on lamp load	max. 10 Hz			
Internal limitation of inductive shut-off voltage	L+ (-52 V)			
Short-circuit protection of output	yes, electronic			
Trigger level	1.5 A			
Number of operating cycle of relay outputs	-			
Switching capacity of contacts	-			
Output data size	16 Byte			
Technical data analog inputs				
Number of inputs	4			
Cable length, shielded	200 m			
Rated load voltage	DC 24 V			
Reverse polarity protection of rated load voltage	✓			
Current consumption from load voltage L+ (without load)	70 mA			
Voltage inputs	✓			
Min. input resistance (voltage range)	120 kΩ			

Signal modules analog Combination modules						
238-2BC00						

Order number	238-2BC00			
Input voltage ranges	+1 V ... +5 V 0 V ... +10 V -10 V ... +10 V -400 mV ... +400 mV -4 V ... +4 V			
Operational limit of voltage ranges	+/-0.3% ... +/-0.7%			
Operational limit of voltage ranges with SFU	-			
Basic error limit voltage ranges with SFU	+/-0.2% ... +/-0.5%			
Basic error limit voltage ranges with SFU	-			
Destruction limit current	-			
Current inputs	✓			
Max. input resistance (current range)	90 Ω			
Input current ranges	+4 mA ... +20 mA 0 mA ... +20 mA -20 mA ... +20 mA			
Operational limit of current ranges	+/-0.3% ... +/-0.8%			
Operational limit of current ranges with SFU	-			
Basic error limit current ranges	+/-0.2% ... +/-0.5%			
Radical error limit current ranges with SFU	-			
Destruction limit current inputs (electrical current)	-			
Destruction limit current inputs (voltage)	-			
Resistance inputs	✓			
Resistance ranges	0 ... 600 Ohm 0 ... 3000 Ohm			
Operational limit of resistor ranges	+/-0.4%			
Operational limit of resistor ranges with SFU	-			
Basic error limit	+/-0.2%			
Basic error limit with SFU	-			
Destruction limit resistance inputs	-			
Resistance thermometer inputs	✓			
Resistance thermometer ranges	Pt100 Pt1000 Ni100 Ni1000			
Operational limit of resistance thermometer ranges	+/-0.4% ... +/-1.0%			
Operational limit of resistance thermometer ranges with SFU	-			
Basic error limit thermoresistor ranges	+/-0.2% ... +/-0.5%			
Basic error limit thermoresistor ranges with SFU	-			
Destruction limit resistance thermometer inputs	-			
Thermocouple inputs	-			
Thermocouple ranges	-			
Operational limit of thermocouple ranges	-			

Signal modules analog Combination modules					
238-2BC00					

Order number	238-2BC00			
Operational limit of thermocouple ranges with SFU	-			
Basic error limit thermoelement ranges	-			
Basic error limit thermoresistor ranges with SFU	-			
Destruction limit thermocouple inputs	-			
Programmable temperature compensation	-			
External temperature compensation	-			
Internal temperature compensation	-			
Internal temperature compensation	-			
Technical unit of temperature measurement	-			
Resolution in bit	16			
Measurement principle	Sigma-Delta			
Basic conversion time	7 ms - 272 ms			
Noise suppression for frequency	50 Hz and 60 Hz			
Initial data size	8 Byte			
Technical data analog outputs				
Number of outputs	2			
Cable length, shielded	200 m			
Rated load voltage	DC 24 V			
Reverse polarity protection of rated load voltage	✓			
Current consumption from load voltage L+ (without load)	70 mA			
Voltage output short-circuit protection	✓			
Voltage outputs	✓			
Min. load resistance (voltage range)	1 kΩ			
Max. capacitive load (current range)	1 μF			
Max. inductive load (current range)	30 mA			
Output voltage ranges	-10 V ... +10 V +1 V ... +5 V 0 V ... +10 V			
Operational limit of voltage ranges	+/-0.4% ... +/-0.8%			
Basic error limit voltage ranges with SFU	+/-0.2% ... +/-0.4%			
Destruction limit against external applied voltage	-			
Current outputs	✓			
Max. in load resistance (current range)	500 Ω			
Max. inductive load (current range)	10 mH			
Max. inductive load (current range)	13 V			
Output current ranges	-20 mA ... +20 mA 0 mA ... +20 mA 0 mA ... +20 mA			
Operational limit of current ranges	+/-0.3% ... +/-0.8%			
Radical error limit current ranges with SFU	+/-0.2% ... +/-0.5%			
	-			
Settling time for ohmic load	0.3 ms			
Settling time for capacitive load	1 ms			
Settling time for inductive load	0.5 ms			

SLIO
100V
200V
300S
500S
HMI
Teleservice
StarterKits
Safety
Solutions
Software
Accessories
Appendix
366

Signal modules analog Combination modules					
238-2BC00					

Order number	238-2BC00			
Resolution in bit	12			
Conversion time	1.50 ms			
Substitute value can be applied	yes			
Output data size	4 Byte			
Status information, alarms, diagnostics				
Status display	yes			
Interrupts	yes			
Process alarm	yes, parameterizable			
Diagnostic interrupt	yes, parameterizable			
Diagnostic functions	yes			
Diagnostics information read-out	possible			
Supply voltage display	green LED per group			
Group error display	red SF LED			
Channel error display	none			
Isolation				
Between channels	-			
Between channels of groups to	-			
Between channels and backplane bus	✓			
Between channels and power supply	✓			
Max. potential difference between circuits	-			
Max. potential difference between inputs (Ucm)	DC 4 V			
Max. potential difference between Mana and Mintern (Uiso)	-			
Max. potential difference between inputs and Mana (Ucm)	-			
Max. potential difference between inputs and Mintern (Uiso)	DC 75 V/ AC 60 V			
Max. potential difference between Mintern and outputs	-			
Insulation tested with	DC 500 V			
Datasizes				
Input bytes	8 + 16			
Output bytes	4 + 16			
Parameter bytes	18 + 71			
Diagnostic bytes	12 + 12			
Housing				
Material	PPE / PA 6.6			
Mounting	Profile rail 35 mm			
Mechanical data				
Dimensions (WxHxD)	50.8 mm x 76 mm x 88 mm			
Weight	150 g			
Environmental conditions				
Operating temperature	0 °C to 60 °C			
Storage temperature	-25 °C to 70 °C			
Certifications				
UL508 certification	yes			

- SLIO
- 100V
- 200V
- 300S
- 500S
- HMI
- Teleservice
- StarterKits
- Safety
- Solutions
- Software
- Accessories
- Appendix

Connections, Interfaces

Signal modules analog Combination modules					
238-2BC00					

238-2BC00



The diagram illustrates the terminal connections for the 238-2BC00 module. It is divided into three main sections: Analog Input (AI), Analog Output (AO), and Digital Input/Output (DIO).

AI (Analog Input): Terminals 1 through 12 are used for AI. Terminal 1 is L+ (+DC 24 V). Terminals 2, 4, 6, 8, 10, and 12 are voltage inputs (V) labeled CH0, CH1, CH2, and CH3. Terminals 3, 5, 7, 9, and 11 are current inputs (A) labeled CH0, CH1, CH2, and CH3.

AO (Analog Output): Terminals 13 through 18 are used for AO. Terminals 13 and 14 are labeled CH4. Terminals 15 and 16 are labeled CH5. Terminal 17 is labeled M_{ANA}. Terminal 18 is labeled M.

DIO (Digital Input/Output): Terminals 1 through 13 are used for DIO. Terminal 1 is L+ (+DC 24 V). Terminals 2 through 13 are digital inputs labeled (A1), (B1), (A2), (B2), (A3), (B3), (G1), (L-1), (G2), (L-2), (G3), and (L-3).

DIO (Digital Output): Terminals 14 through 18 are used for DIO. Terminals 14, 15, 16, and 17 are digital outputs labeled (A1), (B1), (A2), and (B2). Terminal 18 is labeled M.

Communication processors



Structure and Function

Communications processors are used to connect different target and source systems, e.g. via Ethernet to higher-level ERP systems or serially to scanners, printers and other peripherals.

CP 240 - serial

The communication processors CP 240 serial enable the serial process coupling to different target and source systems. Depending on the module they have a RS232 and/or a RS485 interface.

CP 240 - EnOcean

The CP 240 EnOcean enables process coupling on the basis of the EnOcean wireless communication. EnOcean is a battery-free radio system that, due to the short signal duration of 0.5 ms and 10 mW transmitting power, has an energy requirement of only 50 μ Ws. Here, the system uses the energy from the smallest changes in pressure or temperature to power the sensors.

CP 240 - M-Bus

In the case of the CP 240 M-Bus, the process coupling takes place on the basis of the M-Bus communication. The M-Bus System (Metering Bus) is a European-standardized 2-wire fieldbus for acquiring consumption data. Here, the data is transmitted serially via a reverse polarity protected 2-wire line from slave systems (meters) to a master system.

Characteristics

- › Support for all standard protocols (ASCII, STX/ETX, 3964(R), RK512 and Modbus (master, slave))
- › Internal communication via VIPA FCs
- › Compact design
- › LED status indicator
- › Electrically isolated to the backplane bus
- › Assembly with 35 mm profile rail
- › 24 month warranty

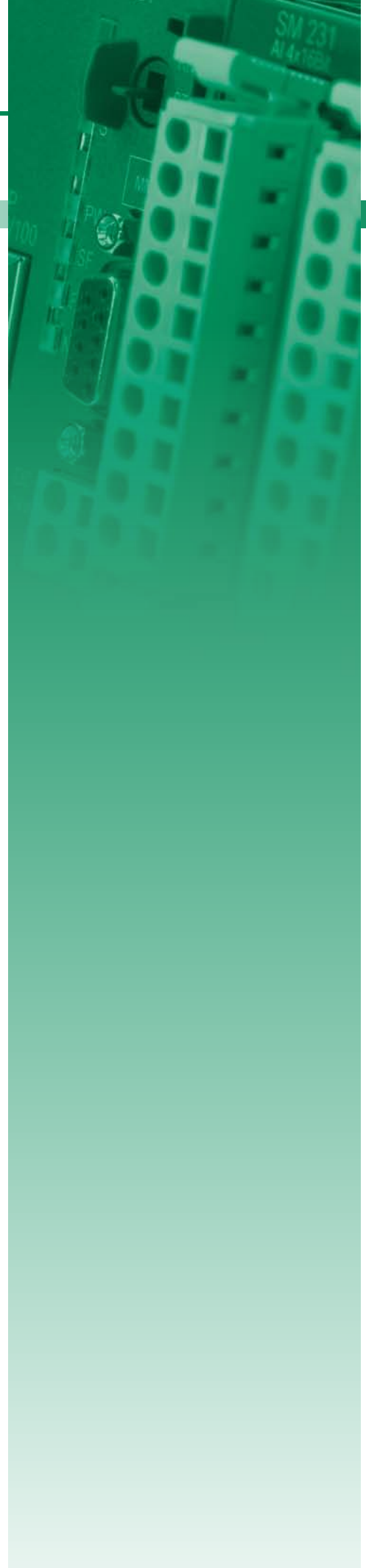



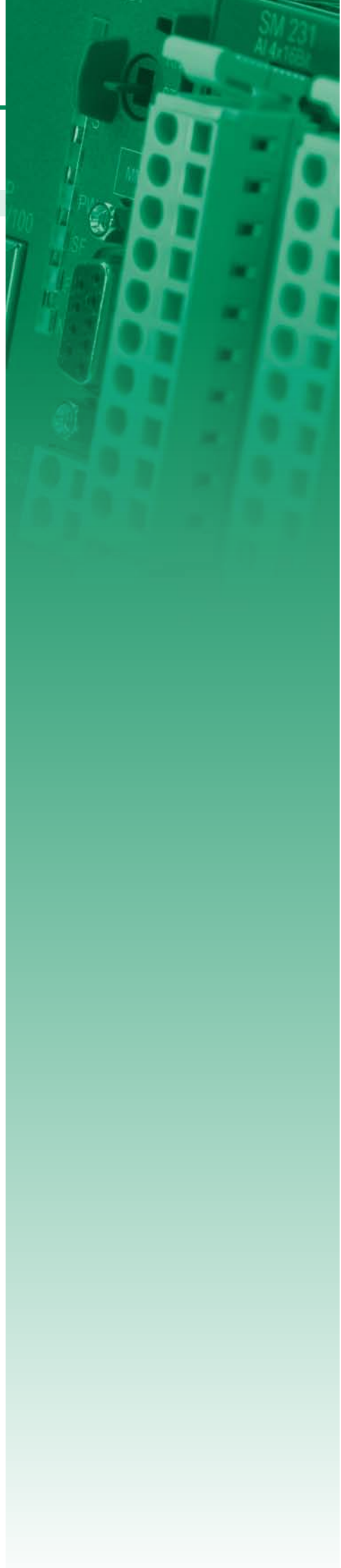

Overview

Order no.	Name/Description	Page
RS232/422/485 and other CPs		
240-1DA10	CM 240 - Mini-switch ▶ 4 Ports for 10/100 MBit/s ▶ "plug and play" through Auto-MDI/MDIX-crossover for 100BASE-TX and 10BASE-T ▶ LEDs for activity, speed and collision	372
240-1BA20	CP 240 - Communication processor ▶ RS232 interface	372
240-1CA20	CP 240 - Communication processor ▶ RS485 interface	372
240-1CA21	CP 240 - Communication processor ▶ RS422/485 interface	372
240-1EA20	CP 240 - Communication processor ▶ 16 Byte parameter data ▶ The transceiver module works at 868.3 MHz	375
240-1FA20	CP 240 - Communication processor ▶ M-Bus master, potential separated ▶ up to 6 slaves	375
Fieldbus master modules		
208-1CA00	IM 208CAN - CANopen master ▶ CANopen master ▶ 125 CAN slaves connectable ▶ Project engineering under VIPA WinCoCT ▶ 40 Transmit PDOs, 40 Receive PDOs	378
208-1DP01	IM 208DP - PROFIBUS-DP master ▶ PROFIBUS-DP master ▶ 125 DP slaves connectable	378
208-1DP11	IM 208DPO - PROFIBUS-DP master ▶ PROFIBUS-DP master ▶ 16 DP slaves connectable ▶ FO interface	378



RS232/422/485 and other CPs

Communication processors RS232/422/485 and other CPs					
240-1DA10	240-1EA20				
240-1BA20	240-1FA20				
240-1CA20					
240-1CA21					

Order number	240-1DA10	240-1BA20	240-1CA20	240-1CA21
Figure				
Type	CM 240, 4port Mini-Switch	CP 240, PtP RS232	CP 240, RS485	CP 240, RS422/485
General information				
Note	-	-	-	-
Features	<ul style="list-style-type: none"> ▶ 4 Ports for 10/100 MBit/s ▶ "plug and play" through Auto-MDI/MDIX-crossover for 100BASE-TX and 10BASE-T ▶ LEDs for activity, speed and collision 	<ul style="list-style-type: none"> ▶ RS232 interface 	<ul style="list-style-type: none"> ▶ RS485 interface 	<ul style="list-style-type: none"> ▶ RS422/485 interface
Current consumption/power loss				
Current consumption from backplane bus	450 mA	150 mA	150 mA	150 mA
Power loss	2 W	0.75 W	0.75 W	0.75 W
Status information, alarms, diagnostics				
Status display	yes	yes	yes	yes
Interrupts	no	no	no	no
Process alarm	no	no	no	no
Diagnostic interrupt	no	no	no	no
Diagnostic functions	no	no	no	no
Diagnostics information read-out	none	possible	possible	possible
Supply voltage display	none	yes	yes	yes
Group error display	none	red LED	red LED	red LED
Channel error display	none	none	none	none
Functionality Sub-D interfaces				
Type	-	-	-	-
Type of interface	-	RS232	RS485	RS422/485
Connector	-	Sub-D, 9-pin, male	Sub-D, 9-pin, female	Sub-D, 9-pin, female
Electrically isolated	-	✓	✓	✓
MPI	-	-	-	-
MP ² (MPI/RS232)	-	-	-	-
Point-to-point interface	-	✓	✓	✓
Point-to-point communication				
PtP communication	-	✓	✓	✓
Interface isolated	✓	✓	✓	✓
RS232 interface	-	✓	-	-
RS422 interface	-	-	-	✓
RS485 interface	-	-	✓	✓
Connector	RJ45	Sub-D, 9-pin, male	Sub-D, 9-pin, female	Sub-D, 9-pin, female
Transmission speed, min.	10 Mbit/s	150 bit/s	150 bit/s	150 bit/s
Transmission speed, max.	100 Mbit/s	115.2 kbit/s	115.2 kbit/s	115.2 kbit/s
Cable length, max.	-	15 m	1200 m	1200 m

Communication processors | RS232/422/485 and other CPs

240-1DA10 240-1BA20 240-1CA20 240-1CA21	240-1EA20 240-1FA20					
--	------------------------	--	--	--	--	--

Order number	240-1DA10	240-1BA20	240-1CA20	240-1CA21
Point-to-point protocol				
ASCII protocol	-	✓	✓	✓
STX/ETX protocol	-	✓	✓	✓
3964(R) protocol	-	✓	✓	✓
RK512 protocol	-	✓	✓	✓
USS master protocol	-	-	-	-
Modbus master protocol	-	✓	✓	✓
Modbus slave protocol	-	✓	✓	✓
Special protocols	-	-	-	-
Datasizes				
Input bytes	-	16	16	16
Output bytes	-	16	16	16
Parameter bytes	-	16	16	16
Diagnostic bytes	-	0	0	0
Housing				
Material	PPE / PA 6.6	PPE	PPE	PPE
Mounting	Profile rail 35 mm	Profile rail 35 mm	Profile rail 35 mm	Profile rail 35 mm
Mechanical data				
Dimensions (WxHxD)	25.4 mm x 76 mm x 78 mm	25.4 mm x 76 mm x 78 mm	25.4 mm x 76 mm x 78 mm	25.4 mm x 76 mm x 78 mm
Weight	50 g	80 g	80 g	80 g
Environmental conditions				
Operating temperature	0 °C to 60 °C	0 °C to 60 °C	0 °C to 60 °C	0 °C to 60 °C
Storage temperature	-25 °C to 70 °C	-25 °C to 70 °C	-25 °C to 70 °C	-25 °C to 70 °C
Certifications				
UL508 certification	yes	yes	yes	yes

Connections, Interfaces

Communication processors | RS232/422/485 and other CPs

240-1DA10
240-1BA20
240-1CA20
240-1CA21

240-1EA20
240-1FA20

240-1DA10



4 x RJ45



- ① Transmit +
- ② Transmit -
- ③ Receive +
- ④ -
- ⑤ -
- ⑥ Receive -
- ⑦ -
- ⑧ -

DC 5 ... 24 V



- ① Ground
- ② 0 V
- ③ + DC 24 V

240-1BA20



RS232

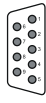

- DCD
- RxD
- TxD
- DTR
- GND
- DSR
- RTS
- CTS
- RI

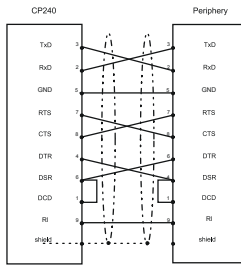

240-1CA20



RS485

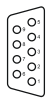

- n.c.
- RxD/TxD-P
- RTS
- MSV
- P5V
- n.c.
- RxD/TxD-N
- n.c.

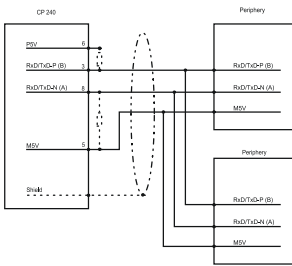

240-1CA21



RS422/485



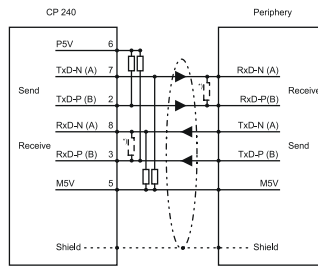

- n.c.
- Tx-D-P (line B) - RS422
- Rx-D-P (line B) - (RS422)
- /Rx-D/Tx-D-P (line B) - (RS485)
- RTS
- MSV
- P5V
- Tx-D-N (line A) - RS422
- Rx-D-N (line A) - RS422
- /Rx-D/Tx-D-N (line A) - (RS485)
- n.c.



RS232/422/485 and other CPs

Communication processors | RS232/422/485 and other CPs

240-1DA10 240-1BA20 240-1CA20 240-1CA21	240-1EA20 240-1FA20				
--	------------------------	--	--	--	--

Order number	240-1EA20	240-1FA20		
Figure				
Type	CP 240, EnOcean	CP 240, M-Bus		
General information				
Note	-	-		
Features	<ul style="list-style-type: none"> ▸ 16 Byte parameter data ▸ The transceiver module works at 868.3 MHz 	<ul style="list-style-type: none"> ▸ M-Bus master, potential separated ▸ up to 6 slaves 		
Current consumption/power loss				
Current consumption from backplane bus	120 mA	300 mA		
Power loss	0.75 W	1.5 W		
Status information, alarms, diagnostics				
Status display	yes	yes		
Interrupts	no	no		
Process alarm	no	no		
Diagnostic interrupt	no	no		
Diagnostic functions	no	no		
Diagnostics information read-out	none	none		
Supply voltage display	yes	yes		
Group error display	red LED	red LED		
Channel error display	none	none		
Functionality Sub-D interfaces				
Type	-	-		
Type of interface	-	-		
Connector	-	-		
Electrically isolated	-	-		
MPI	-	-		
MP2 ¹ (MPI/RS232)	-	-		
Point-to-point interface	-	-		
Point-to-point communication				
PtP communication	-	-		
Interface isolated	-	✓		
RS232 interface	-	-		
RS422 interface	-	-		
RS485 interface	-	-		
Connector	SMA antenna socket	-		
Transmission speed, min.	-	300 bit/s		
Transmission speed, max.	9.6 kbit/s	9.6 kbit/s		
Cable length, max.	-	-		

Communication processors RS232/422/485 and other CPs						
240-1DA10	240-1EA20					
240-1BA20	240-1FA20					
240-1CA20						
240-1CA21						

Order number	240-1EA20	240-1FA20		
Point-to-point protocol				
ASCII protocol	-	-		
STX/ETX protocol	-	-		
3964(R) protocol	-	-		
RK512 protocol	-	-		
USS master protocol	-	-		
Modbus master protocol	-	-		
Modbus slave protocol	-	-		
Special protocols	EnOcean	M-Bus master		
Datasizes				
Input bytes	16	16		
Output bytes	16	16		
Parameter bytes	16	16		
Diagnostic bytes	0	0		
Housing				
Material	PPE	PPE / PA 6.6		
Mounting	Profile rail 35 mm	Profile rail 35 mm		
Mechanical data				
Dimensions (WxHxD)	25.4 mm x 76 mm x 78 mm	25.4 mm x 76 mm x 78 mm		
Weight	80 g	80 g		
Environmental conditions				
Operating temperature	0 °C to 60 °C	0 °C to 60 °C		
Storage temperature	-25 °C to 70 °C	-25 °C to 70 °C		
Certifications				
UL508 certification	yes	yes		

Connections, Interfaces

Communication processors | RS232/422/485 and other CPs

240-1DA10 240-1BA20 240-1CA20 240-1CA21	240-1EA20 240-1FA20					
--	------------------------	--	--	--	--	--

240-1EA20



ANT.



① SMA antenna

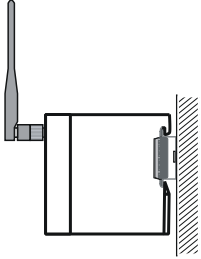

240-1FA20



M-Bus

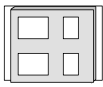

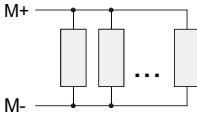

1 ① M+
2 ② M-



Fieldbus master modules

Communication processors Fieldbus master modules						
208-1CA00						
208-1DP01						
208-1DP11						

Order number	208-1CA00	208-1DP01	208-1DP11	
Figure				
Type	IM 208CAN, CANopen master	IM 208DP, PROFIBUS-DP master	IM 208DPO, PROFIBUS-DP master FO interface	
General information				
Note	-	-	-	
Features	<ul style="list-style-type: none"> ▸ CANopen master ▸ 125 CAN slaves connectable ▸ Project engineering under VIPA WinCoCT ▸ 40 Transmit PDOs, 40 Receive PDOs 	<ul style="list-style-type: none"> ▸ PROFIBUS-DP master ▸ 125 DP slaves connectable 	<ul style="list-style-type: none"> ▸ PROFIBUS-DP master ▸ 16 DP slaves connectable ▸ FO interface 	
Current consumption/power loss				
Current consumption from backplane bus	300 mA	450 mA	450 mA	
Power loss	1.5 W	2 W	2 W	
Status information, alarms, diagnostics				
Status display	yes	yes	yes	
Interrupts	yes, parameterizable	yes, parameterizable	yes, parameterizable	
Process alarm	no	yes, parameterizable	yes, parameterizable	
Diagnostic interrupt	yes, parameterizable	yes, parameterizable	yes, parameterizable	
Diagnostic functions	yes	yes	yes	
Diagnostics information read-out	possible	possible	possible	
Supply voltage display	none	none	none	
Group error display	red LED	red LED	red LED	
Channel error display	none	none	none	
Functionality Sub-D interfaces				
Type	-	-	-	
Type of interface	CAN	RS485	FOC	
Connector	Sub-D, 9-pin, male	Sub-D, 9-pin, female	2-pin FOC POF/HCS	
Electrically isolated	✓	✓	✓	
MPI	-	-	-	
MP ² I (MPI/RS232)	-	-	-	
Point-to-point interface	-	-	-	
Housing				
Material	PPE	PPE	PPE	
Mounting	Profile rail 35 mm	Profile rail 35 mm	Profile rail 35 mm	

Communication processors | Fieldbus master modules

208-1CA00 208-1DP01 208-1DP11						
-------------------------------------	--	--	--	--	--	--

Order number	208-1CA00	208-1DP01	208-1DP11	
Mechanical data				
Dimensions (WxHxD)	25.4 mm x 76 mm x 78 mm	25.4 mm x 76 mm x 78 mm	25.4 mm x 76 mm x 78 mm	
Weight	80 g	90 g	100 g	
Environmental conditions				
Operating temperature	0 °C to 60 °C	0 °C to 60 °C	0 °C to 60 °C	
Storage temperature	-25 °C to 70 °C	-25 °C to 70 °C	-25 °C to 70 °C	
Certifications				
UL508 certification	yes	yes	yes	

Connections, Interfaces

Communication processors Fieldbus master modules						
208-1CA00						
208-1DP01						
208-1DP11						

208-1CA00



CAN

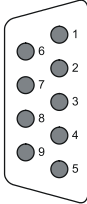

- ① n. c.
- ② CAN low
- ③ CAN Ground
- ④ n. c.
- ⑤ shield
- ⑥ optional Ground
- ⑦ CAN high
- ⑧ n. c.
- ⑨ n. c.

DP RS485

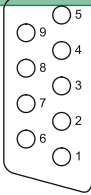

- ① shield
- ② n. c.
- ③ RxD/TxD-P (line B)
- ④ RTS
- ⑤ M5V
- ⑥ P5V
- ⑦ n. c.
- ⑧ RxD/TxD-N (line A)
- ⑨ n. c.

208-1DP01



DP RS485

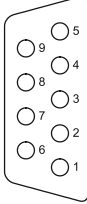

- ① M5V
- ② n. c.
- ③ RxD/TxD-P (line B)
- ④ RTS
- ⑤ M5V
- ⑥ P5V
- ⑦ n. c.
- ⑧ RxD/TxD-N (line A)
- ⑨ n. c.

208-1DP11



LWL

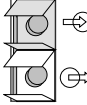

- ① Rx
- ② Tx

Function modules



Structure and Function

Function modules are intelligent modules, the technological tasks such as position determination, counting and positioning, and other complex functions in the automation run autonomously.

FM 250 - SSI Modules

The SSI module enables the connection of absolute coded reading recorders with an SSI interface. The module converts the serial information of the reading recorder into parallel information and makes this available to the controller. There is a possibility to transmit the data in gray or binary code. In addition to the SSI signals clock, data and encoder supply there are two additional outputs that can be set or reset when crossing.

FM 250 - Counter

The counter counts the pulses of the connected sensor and processes these stimuli according to the selected module. The module has 2 or 4 channels at a width of 32 bit or 16 bit respectively, with 20 counter modes and two DC 24 V outputs, which are controlled depending on the mode.

FM 253/254 – Positioning Modules

Positioning modules can be used for point-to-point positioning and for complex travel profiles with the highest standards of accuracy, dynamism and speed. The FM 253 is a Positioning module for controlling a stepper motor. Stepper motors are used when maximum torque at low speeds is required and the target position is to be achieved and maintained without overshooting. The FM 254 is a positioning module for controlling a servo drive. The module operates independently and is controlled by a corresponding application program from the CPU. The module has 3 inputs for connecting limit switches and can control 2 outputs.

Characteristics

- Compact design
- LED status indicator
- Electrically isolated to the backplane bus
- Assembly with 35 mm profile rail
- 24 month warranty

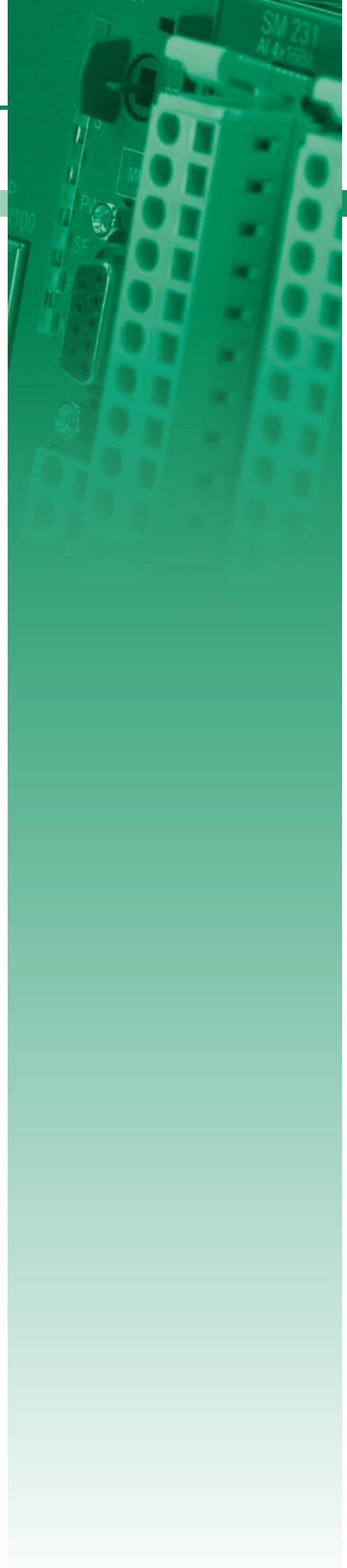

Overview

Order no.	Name/Description	Page
Counter modules		
250-1BA00	FM 250 - Counter module <ul style="list-style-type: none"> › 2/4 channels with 32/16 Bit › DC 24 V or via backplane bus › Free configurable DC 24 V outputs (1 A) › Up to 1 MHz 	384
SSI modules		
250-1BS00	FM 250S - SSI module <ul style="list-style-type: none"> › 1 SSI channel › Direct power supply to the SSI transducer › Baud rate: 100/300/600 kBit/s (default: 300 kBit/s) › 2 configurable digital outputs, one may be used as hold input 	388
Positioning modules		
253-1BA00	FM 253 - Positioning module <ul style="list-style-type: none"> › Positioning module for 1axis drive with stepper › 3 inputs for connecting end switches and 2 outputs 	392
254-1BA00	FM 254 - Positioning module <ul style="list-style-type: none"> › Positioning module for 1axis drive with servo › For drives with an analog set point interface (+/-10 V control voltage) › 3 inputs for connecting end switches and 2 outputs 	392

Counter modules

Function modules Counter modules						
250-1BA00						

Order number	250-1BA00			
Figure				
Type	FM 250			
General information				
Note	-			
Features	<ul style="list-style-type: none"> ▸ 2/4 channels with 32/16 Bit ▸ DC 24 V or via backplane bus ▸ Free configurable DC 24 V outputs (1 A) ▸ Up to 1 MHz 			
Current consumption/power loss				
Current consumption from backplane bus	80 mA			
Power loss	2.5 W			
Technical data digital inputs				
Number of inputs	6			
Cable length, shielded	1000 m			
Cable length, unshielded	600 m			
Rated load voltage	DC 24 V			
Reverse polarity protection of rated load voltage	✓			
Current consumption from load voltage L+ (without load)	-			
Rated value	-			
Input voltage for signal "0"	DC 0...5 V			
Input voltage for signal "1"	DC 15...28.8 V			
Input voltage hysteresis	-			
Frequency range	-			
Input resistance	2 kΩ			
Input current for signal "1"	14 mA			
Connection of Two-Wire-BEROs possible	-			
Max. permissible BERO quiescent current	-			
Input delay of "0" to "1"	0.8 μs			
Input delay of "1" to "0"	0.8 μs			
Number of simultaneously utilizable inputs horizontal configuration	6			
Number of simultaneously utilizable inputs vertical configuration	6			
Input characteristic curve	-			
Initial data size	10 Byte			

SLIO
100V
200V
300S
500S
HMI
Teleservice
StarterKits
Safety
Solutions
Software
Accessories
Appendix

Function modules Counter modules						
250-1BA00						

Order number	250-1BA00			
Technical data digital outputs				
Number of outputs	2			
Cable length, shielded	1000 m			
Cable length, unshielded	600 m			
Rated load voltage	DC 24 V			
Reverse polarity protection of rated load voltage	✓			
Current consumption from load voltage L+ (without load)	10 mA			
Total current per group, vertical configuration	2 A			
Output voltage signal "1" at min. current	L+ (-125 mV)			
Output voltage signal "1" at max. current	L+ (-0.8 V)			
Output current at signal "1", rated value	1 A			
Output current, permitted range to 40°C	-			
Output current, permitted range to 60°C	-			
Output delay of "0" to "1"	max. 100 µs			
Output delay of "1" to "0"	max. 500 µs			
Minimum load current	-			
Lamp load	10 W			
Parallel switching of outputs for redundant control of a load	not possible			
Parallel switching of outputs for increased power	not possible			
Actuation of digital input	-			
Switching frequency with resistive load	max. 1000 Hz			
Switching frequency with inductive load	max. 0.5 Hz			
Switching frequency on lamp load	max. 10 Hz			
Internal limitation of inductive shut-off voltage	L+ (-52 V)			
Short-circuit protection of output	yes, electronic			
Trigger level	3 A			
Number of operating cycle of relay outputs	-			
Switching capacity of contacts	-			
Output data size	10 Byte			
Technical data counters				
Number of counters	2			
Counter width	1x32 Bit / 2x16 Bit			
Maximum input frequency	1 MHz			
Maximum count frequency	1 MHz			
Mode incremental encoder	✓			
Mode pulse / direction	✓			
Mode pulse	✓			
Mode frequency counter	✓			
Mode period measurement	✓			
Gate input available	✓			
Latch input available	-			

Function modules Counter modules						
250-1BA00						

Order number	250-1BA00			
Reset input available	✓			
Counter output available	✓			
Status information, alarms, diagnostics				
Status display	yes			
Interrupts	no			
Process alarm	no			
Diagnostic interrupt	no			
Diagnostic functions	no			
Diagnostics information read-out	none			
Supply voltage display	yes			
Group error display	red LED			
Channel error display	none			
Isolation				
Between channels	-			
Between channels of groups to	-			
Between channels and backplane bus	✓			
Between channels and power supply	-			
Max. potential difference between circuits	-			
Max. potential difference between inputs (Ucm)	-			
Max. potential difference between Mana and Mintern (Uiso)	-			
Max. potential difference between inputs and Mana (Ucm)	-			
Max. potential difference between inputs and Mintern (Uiso)	-			
Max. potential difference between Mintern and outputs	-			
Insulation tested with	DC 500 V			
Datasizes				
Input bytes	10			
Output bytes	10			
Parameter bytes	4			
Diagnostic bytes	0			
Housing				
Material	PPE / PA 6.6			
Mounting	Profile rail 35 mm			
Mechanical data				
Dimensions (WxHxD)	25.4 mm x 76 mm x 78 mm			
Weight	230 g			
Environmental conditions				
Operating temperature	0 °C to 60 °C			
Storage temperature	-25 °C to 70 °C			
Certifications				
UL508 certification	yes			

Connections, Interfaces

Function modules Counter modules						
250-1BA00						

250-1BA00



The diagram shows a 10-pin terminal block with the following connections:

- 1: L+
- 2: IN1 counter 0/1
- 3: IN2 counter 0/1
- 4: IN3 counter 0/1
- 5: OUT0 counter 0/1
- 6: IN4 counter 2/3
- 7: IN5 counter 2/3
- 8: IN6 counter 2/3
- 9: OUT1 counter 2/3
- 10: M

A DC 24 V power source is connected to terminal 1 (L+) and terminal 10 (M).

SSI modules

Function modules SSI modules						
250-1BS00						

Order number	250-1BS00			
Figure				
Type	FM 250S			
General information				
Note	-			
Features	<ul style="list-style-type: none"> ▶ 1 SSI channel ▶ Direct power supply to the SSI transducer ▶ Baud rate: 100/300/600 kBit/s (default: 300 kBit/s) ▶ 2 configurable digital outputs, one may be used as hold input 			
Current consumption/power loss				
Current consumption from backplane bus	120 mA			
Power loss	1 W			
Technical data digital inputs				
Number of inputs	2			
Cable length, shielded	1000 m			
Cable length, unshielded	600 m			
Rated load voltage	DC 24 V			
Reverse polarity protection of rated load voltage	✓			
Current consumption from load voltage L+ (without load)	-			
Rated value	-			
Input voltage for signal "0"	Differential signal RS422			
Input voltage for signal "1"	Differential signal RS422			
Input voltage hysteresis	-			
Frequency range	-			
Input resistance	-			
Input current for signal "1"	-			
Connection of Two-Wire-BEROs possible	-			
Max. permissible BERO quiescent current	-			
Input delay of "0" to "1"	-			
Input delay of "1" to "0"	-			
Number of simultaneously utilizable inputs horizontal configuration	-			
Number of simultaneously utilizable inputs vertical configuration	-			
Input characteristic curve	-			
Initial data size	4 Byte			

SLIO
100V
200V
300S
500S
HMI
Teleservice
StarterKits
Safety
Solutions
Software
Accessories
Appendix

Function modules SSI modules						
250-1BS00						

Order number	250-1BS00			
Technical data digital outputs				
Number of outputs	2			
Cable length, shielded	1000 m			
Cable length, unshielded	600 m			
Rated load voltage	DC 24 V			
Reverse polarity protection of rated load voltage	✓			
Current consumption from load voltage L+ (without load)	5 mA			
Total current per group, horizontal configuration, 40°C	2 A			
Total current per group, horizontal configuration, 60°C	2 A			
Total current per group, vertical configuration	2 A			
Output voltage signal "1" at min. current	L+ (-0.8 V)			
Output voltage signal "1" at max. current	L+ (-125 mV)			
Output current at signal "1", rated value	1 A			
Output current, permitted range to 40°C	-			
Output current, permitted range to 60°C	-			
Output current at signal "0" max. (residual current)	-			
Output delay of "0" to "1"	max. 100 µs			
Output delay of "1" to "0"	max. 350 µs			
Minimum load current	-			
Lamp load	5 W			
Parallel switching of outputs for redundant control of a load	not possible			
Parallel switching of outputs for increased power	not possible			
Actuation of digital input	-			
Switching frequency with resistive load	max. 1000 Hz			
Switching frequency with inductive load	max. 0.5 Hz			
Switching frequency on lamp load	max. 10 Hz			
Internal limitation of inductive shut-off voltage	L+ (-52 V)			
Short-circuit protection of output	yes, electronic			
Trigger level	1.8 A			
Number of operating cycle of relay outputs	-			
Switching capacity of contacts	-			
Output data size	4 Byte			
Status information, alarms, diagnostics				
Status display	yes			
Interrupts	no			
Process alarm	no			
Diagnostic interrupt	no			
Diagnostic functions	no			
Diagnostics information read-out	none			

SLIO
100V
200V
300S
500S
HMI
Teleservice
StarterKits
Safety
Solutions
Software
Accessories
Appendix

Function modules SSI modules						
250-1BS00						

Order number	250-1BS00			
Supply voltage display	yes			
Group error display	yes			
Channel error display	none			
Isolation				
Between channels	-			
Between channels of groups to	-			
Between channels and backplane bus	✓			
Between channels and power supply	-			
Max. potential difference between circuits	-			
Max. potential difference between inputs (Ucm)	-			
Max. potential difference between Mana and Mintern (Uiso)	-			
Max. potential difference between inputs and Mana (Ucm)	-			
Max. potential difference between inputs and Mintern (Uiso)	-			
Max. potential difference between Mintern and outputs	-			
Insulation tested with	DC 500 V			
Datasizes				
Input bytes	4			
Output bytes	4			
Parameter bytes	6			
Diagnostic bytes	0			
Housing				
Material	PPE / PA 6.6			
Mounting	Profile rail 35 mm			
Mechanical data				
Dimensions (WxHxD)	25.4 mm x 76 mm x 78 mm			
Weight	100 g			
Environmental conditions				
Operating temperature	0 °C to 60 °C			
Storage temperature	-25 °C to 70 °C			
Certifications				
UL508 certification	yes			

Connections, Interfaces

Function modules | SSI modules

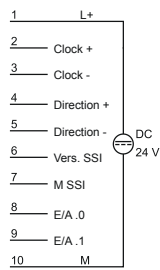

250-1BS00						
-----------	--	--	--	--	--	--

250-1BS00



Positioning modules

Function modules Positioning modules						
253-1BA00						
254-1BA00						

Order number	253-1BA00	254-1BA00		
Figure				
Type	FM 253	FM 254		
General information				
Note	-	-		
Features	<ul style="list-style-type: none"> ▶ Positioning module for 1axis drive with stepper ▶ 3 inputs for connecting end switches and 2 outputs 	<ul style="list-style-type: none"> ▶ Positioning module for 1axis drive with servo ▶ For drives with an analog set point interface (+/-10 V control voltage) ▶ 3 inputs for connecting end switches and 2 outputs 		
Current consumption/power loss				
Current consumption from backplane bus	500 mA	200 mA		
Power loss	3 W	2.5 W		
Status information, alarms, diagnostics				
Status display	yes	yes		
Interrupts	no	no		
Process alarm	no	no		
Diagnostic interrupt	no	no		
Diagnostic functions	no	no		
Diagnostics information read-out	none	none		
Supply voltage display	yes	yes		
Group error display	red LED	red LED		
Channel error display	none	none		
Datasizes				
Input bytes	16	16		
Output bytes	16	16		
Parameter bytes	18	18		
Diagnostic bytes	0	0		
Housing				
Material	PPE / PA 6.6	PPE / PA 6.6		
Mounting	Profile rail 35 mm	Profile rail 35 mm		
Mechanical data				
Dimensions (WxHxD)	25.4 mm x 76 mm x 78 mm	25.4 mm x 76 mm x 78 mm		
Weight	70 g	130 g		
Environmental conditions				
Operating temperature	0 °C to 60 °C	0 °C to 60 °C		
Storage temperature	-25 °C to 70 °C	-25 °C to 70 °C		
Certifications				
UL508 certification	yes	yes		

SLIO
100V
200V
300S
500S
HMI
Teleservice
StarterKits
Safety
Solutions
Software
Accessories
Appendix

Connections, Interfaces

Function modules Positioning modules						
253-1BA00						
254-1BA00						

253-1BA00

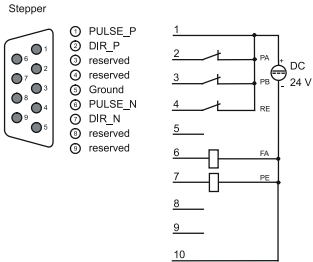

254-1BA00

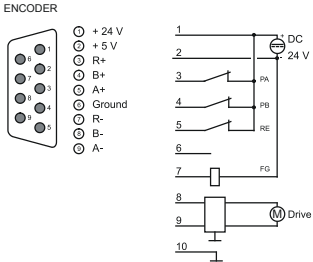

Interface modules



Structure and Function

Interface modules extend deployed control systems with up to three peripheral lines (central max. 32 modules).

Fieldbus slave modules are used for the decentralized expansion of control systems (with a fieldbus master interface in or on the CPU) with up to 128 fieldbus slave modules, plus peripheral modules.

Characteristics (Fieldbus slave modules)

- › Available for PROFIBUS, CANopen, INTERBUS, DeviceNet, Ethernet
- › Cross manufacturer mixed operation is possible
- › Depending on the version also with fiber-optic interface
- › Advanced diagnostics
- › Electrically isolated to the backplane bus
- › LED status indicator
- › Compact design
- › Assembly with 35 mm profile rail
- › 24 month warranty

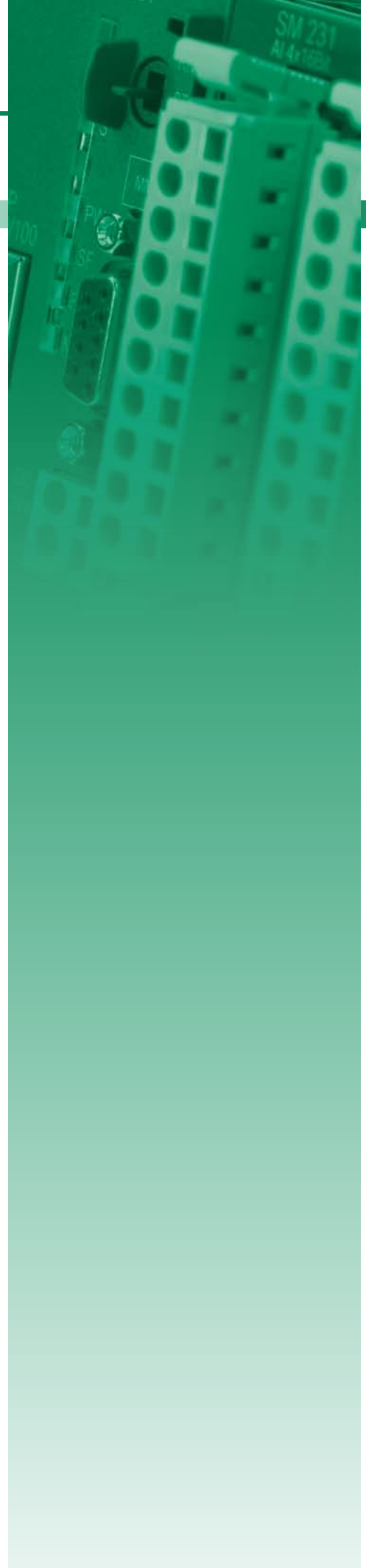

Overview

Order no.	Name/Description	Page
Row interface connection		
260-1AA00	IM 260 - Interface module ‣ Only be used in conjunction with the PC 288 or a CPU	396
261-1CA00	IM 261 - Interface module ‣ Only be used in conjunction with the PC 288 or a CPU	396
Fieldbus slave modules without I/Os		
253-1CA01	IM 253CAN - CANopen slave ‣ CANopen slave ‣ 10 Rx and 10 Tx PDO ‣ 2 SDOs ‣ PDO linking ‣ PDO mapping	399
253-1CA30	IM 253CAN - CANopen slave ECO ‣ CANopen slave ‣ 10 Rx and 10 Tx PDO ‣ 2 SDOs ‣ PDO linking ‣ PDO mapping	399
253-1DN00	IM 253DN - DeviceNET slave ‣ Group 2 only Device - employs predefined connection set ‣ Baud rates: 125, 250, 500 kBit/s ‣ For max. 32 peripheral modules (8 analog)	399
253-1DP01	IM 253DP - PROFIBUS-DP slave ‣ PROFIBUS-DP slave (DP-V0, DP-V1) ‣ For max. 32 peripheral modules (16 analog) ‣ 244 Byte input and 244 Byte output data	399
253-1DP11	IM 253DPO - PROFIBUS-DP slave ‣ PROFIBUS-DP slave (DP-V0, DP-V1) ‣ For max. 32 peripheral modules (16 analog) ‣ 244 Byte input and 244 Byte output data	402
253-1DP31	IM 253DP - PROFIBUS-DP slave ECO ‣ PROFIBUS-DP slave (DP-V0, DP-V1) ‣ For max. 8 peripheral modules ‣ 244 Byte input and 244 Byte output data	402
253-1IB00	IM 253IBS - INTERBUS slave ‣ INTERBUS slave ‣ For 16 input and 16 output modules	402
253-1NE00	IM 253NET - Ethernet slave ‣ Ethernet coupler with Modbus/TCP and Siemens S5 Header protocol ‣ For max. 32 peripheral modules ‣ Max. 256 Byte I/O data ‣ RJ45 jack 100BaseTX, 10BaseT	402

Row interface connection

Interface modules Row interface connection						
260-1AA00						
261-1CA00						

Order number	260-1AA00	261-1CA00		
Figure				
Type	IM 260, Basic interface	IM 261, Row interface		
General information				
Note	-	-		
Features	<ul style="list-style-type: none"> Only be used in conjunction with the PC 288 or a CPU 	<ul style="list-style-type: none"> Only be used in conjunction with the PC 288 or a CPU 		
Technical data power supply				
Power supply (rated value)	DC 24 V	-		
Power supply (permitted range)	DC 20.4...28.8 V	-		
Reverse polarity protection	✓	-		
Current consumption (no-load operation)	50 mA	-		
Current consumption (rated value)	1.9 A	-		
Inrush current	-	-		
Max. current drain at backplane bus	4 A	1.5 A		
Max. current drain load supply	-	-		
Power loss	2 W	1 W		
Status information, alarms, diagnostics				
Status display	yes	yes		
Interrupts	no	no		
Process alarm	no	no		
Diagnostic interrupt	no	no		
Diagnostic functions	no	no		
Diagnostics information read-out	none	none		
Supply voltage display	yes	yes		
Group error display	none	none		
Channel error display	none	none		
Hardware configuration				
Racks, max.	4	1		
Modules per rack, max.	16	16		
Number of digital modules, max.	16	16		
Number of analog modules, max.	16	16		

Interface modules Row interface connection						
260-1AA00 261-1CA00						

Order number	260-1AA00	261-1CA00		
Housing				
Material	PPE / PA 6.6	PPE		
Mounting	Profile rail 35 mm	Profile rail 35 mm		
Mechanical data				
Dimensions (WxHxD)	25.4 mm x 76 mm x 78 mm	25.4 mm x 76 mm x 78 mm		
Weight	100 g	90 g		
Environmental conditions				
Operating temperature	0 °C to 60 °C	0 °C to 60 °C		
Storage temperature	-25 °C to 70 °C	-25 °C to 70 °C		
Certifications				
UL508 certification	yes	yes		

Connections, Interfaces

Interface modules Row interface connection						
260-1AA00						
261-1CA00						

260-1AA00



Basic interface
OUT



261-1CA00



Row interface
IN



OUT



Fieldbus slave modules without I/Os

Interface modules		Fieldbus slave modules without I/Os			
253-1CA01	253-1CA30	253-1DN00	253-1DP01	253-1DP11	253-1DP31
253-1CA01	253-1CA30	253-1DN00	253-1DP01	253-1IB00	253-1NE00

Order number	253-1CA01	253-1CA30	253-1DN00	253-1DP01
Figure				
Type	IM 253CAN, CANopen slave	IM 253CAN, CANopen slave	IM 253DN, DeviceNET slave	IM 253DP, PROFIBUS-DP slave
General information				
Note	-	-	-	-
Features	<ul style="list-style-type: none"> ▸ CANopen slave ▸ 10 Rx and 10 Tx PDO ▸ 2 SDOs ▸ PDO linking ▸ PDO mapping 	<ul style="list-style-type: none"> ▸ CANopen slave ▸ 10 Rx and 10 Tx PDO ▸ 2 SDOs ▸ PDO linking ▸ PDO mapping 	<ul style="list-style-type: none"> ▸ Group 2 only Device - employs predefined connection set ▸ Baud rates: 125, 250, 500 kBit/s ▸ For max. 32 peripheral modules (8 analog) 	<ul style="list-style-type: none"> ▸ PROFIBUS-DP slave (DP-V0, DP-V1) ▸ For max. 32 peripheral modules (16 analog) ▸ 244 Byte input and 244 Byte output data
Technical data power supply				
Power supply (rated value)	DC 24 V	DC 24 V	DC 24 V	DC 24 V
Power supply (permitted range)	DC 20.4...28.8 V	DC 20.4...28.8 V	DC 20.4...28.8 V	DC 20.4...28.8 V
Reverse polarity protection	✓	✓	✓	✓
Current consumption (no-load operation)	50 mA	50 mA	50 mA	70 mA
Current consumption (rated value)	800 mA	300 mA	800 mA	1 A
Inrush current	65 A	60 A	65 A	65 A
I^2t	0.85 A ² s	0.4 A ² s	0.85 A ² s	0.85 A ² s
Max. current drain at backplane bus	3.5 A	0.8 A	3.5 A	3.5 A
Max. current drain load supply	-	-	-	-
Power loss	2 W	1.5 W	2 W	2.5 W
Status information, alarms, diagnostics				
Status display	yes	yes	yes	yes
Interrupts	yes, parameterizable	yes, parameterizable	no	yes, parameterizable
Process alarm	no	no	no	yes, parameterizable
Diagnostic interrupt	yes, parameterizable	yes, parameterizable	no	yes, parameterizable
Diagnostic functions	yes, parameterizable	yes, parameterizable	yes	yes, parameterizable
Diagnostics information read-out	possible	possible	none	possible
Supply voltage display	yes	yes	yes	green LED
Service Indicator	-	-	-	-
Group error display	yes	yes	yes	yes
Channel error display	none	none	none	none

Interface modules Fieldbus slave modules without I/Os					
253-1CA01	253-1DP11				
253-1CA30	253-1DP31				
253-1DN00	253-1IB00				
253-1DP01	253-1NE00				

Order number	253-1CA01	253-1CA30	253-1DN00	253-1DP01
Hardware configuration				
Racks, max.	1	1	1	1
Modules per rack, max.	32	8	32	32
Number of digital modules, max.	32	8	32	32
Number of analog modules, max.	16	8	8	16
Communication				
Fieldbus	CANopen	CANopen	DeviceNet	PROFIBUS-DP to EN 50170
Type of interface	CAN	CAN	CAN	RS485
Connector	Sub-D, 9-pin, male	Sub-D, 9-pin, male	5-pin Open Style Connector	Sub-D, 9-pin, female
Topology	Linear bus with bus termination at both ends	Linear bus with bus termination at both ends	Linear bus with bus termination at both ends	Linear bus with bus termination at both ends
Electrically isolated	✓	✓	✓	✓
Number of participants, max.	127	127	64	125
Node addresses	1 - 99	1 - 99	0 - 63	1 - 99
Transmission speed, min.	10 kbit/s	10 kbit/s	125 kbit/s	9.6 kbit/s
Transmission speed, max.	1 Mbit/s	1 Mbit/s	500 kbit/s	12 Mbit/s
Address range inputs, max.	80 Byte	80 Byte	256 Byte	244 Byte
Address range outputs, max.	80 Byte	80 Byte	256 Byte	244 Byte
Number of TxPDOs, max.	10	10	-	-
Number of RxPDOs, max.	10	10	-	-
Housing				
Material	PPE / PA 6.6	PPE / PA 6.6	PPE / PA 6.6	PPE / PA 6.6
Mounting	Profile rail 35 mm	Profile rail 35 mm	Profile rail 35 mm	Profile rail 35 mm
Mechanical data				
Dimensions (WxHxD)	25.4 mm x 76 mm x 78 mm	25.4 mm x 76 mm x 78 mm	25.4 mm x 76 mm x 78 mm	25.4 mm x 76 mm x 78 mm
Weight	100 g	90 g	90 g	100 g
Environmental conditions				
Operating temperature	0 °C to 60 °C	0 °C to 60 °C	0 °C to 60 °C	0 °C to 60 °C
Storage temperature	-25 °C to 70 °C	-25 °C to 70 °C	-25 °C to 70 °C	-25 °C to 70 °C
Certifications				
UL508 certification	yes	yes	yes	yes

Connections, Interfaces

Interface modules | Fieldbus slave modules without I/Os

253-1CA01	253-1DP11				
253-1CA30	253-1DP31				
253-1DN00	253-1IB00				
253-1DP01	253-1NE00				

253-1CA01



CAN

- ① n. c.
- ② CAN low
- ③ CAN Ground
- ④ n. c.
- ⑤ shield
- ⑥ optional Ground
- ⑦ CAN high
- ⑧ n. c.
- ⑨ n. c.

X1

- ① + DC 24 V
- ② 0 V

253-1CA30



CAN

- ① n. c.
- ② CAN low
- ③ CAN Ground
- ④ n. c.
- ⑤ shield
- ⑥ optional Ground
- ⑦ CAN high
- ⑧ n. c.
- ⑨ n. c.

X1

- ① + DC 24 V
- ② 0 V

253-1DN00



DeviceNet

- ① GND
- ② CAN low
- ③ Drain
- ④ CAN high
- ⑤ DC 24 V

X1

- ① + DC 24 V
- ② 0 V

253-1DP01



DP RS485





- ① n. c.
- ② M24V
- ③ Rx/D/TxD-P (line B)
- ④ RTS
- ⑤ M5V
- ⑥ P5V
- ⑦ P24V
- ⑧ Rx/D/TxD-N (line A)
- ⑨ n. c.

X1

- ① + DC 24 V
- ② 0 V

Fieldbus slave modules without I/Os

Interface modules Fieldbus slave modules without I/Os					
253-1CA01	253-1DP11				
253-1CA30	253-1DP31				
253-1DN00	253-1IB00				
253-1DP01	253-1NE00				

Order number	253-1DP11	253-1DP31	253-1IB00	253-1NE00
Figure				
Type	IM 253DPO, PROFIBUS-DP slave	IM 253DP, PROFIBUS-DP slave	IM 253IBS, INTERBUS slave	IM 253NET, Ethernet slave
General information				
Note	-	-	-	-
Features	<ul style="list-style-type: none"> ▸ PROFIBUS-DP slave (DP-V0, DP-V1) ▸ For max. 32 peripheral modules (16 analog) ▸ 244 Byte input and 244 Byte output data 	<ul style="list-style-type: none"> ▸ PROFIBUS-DP slave (DP-V0, DP-V1) ▸ For max. 8 peripheral modules ▸ 244 Byte input and 244 Byte output data 	<ul style="list-style-type: none"> ▸ INTERBUS slave ▸ For 16 input and 16 output modules 	<ul style="list-style-type: none"> ▸ Ethernet coupler with Modbus/TCP and Siemens S5 Header protocol ▸ For max. 32 peripheral modules ▸ Max. 256 Byte I/O data ▸ RJ45 jack 100BaseTX, 10BaseT
Technical data power supply				
Power supply (rated value)	DC 24 V	DC 24 V	DC 24 V	DC 24 V
Power supply (permitted range)	DC 20.4...28.8 V	DC 20.4...28.8 V	DC 20.4...28.8 V	DC 20.4...28.8 V
Reverse polarity protection	✓	✓	✓	✓
Current consumption (no-load operation)	70 mA	50 mA	50 mA	80 mA
Current consumption (rated value)	1 A	300 mA	800 mA	1 A
Inrush current	65 A	60 A	60 A	65 A
I _{Δt}	0.85 A ² s	0.4 A ² s	0.6 A ² s	0.85 A ² s
Max. current drain at backplane bus	3.5 A	0.8 A	3.5 A	3.5 A
Max. current drain load supply	-	-	-	-
Power loss	2.5 W	1.5 W	2 W	2.5 W
Status information, alarms, diagnostics				
Status display	yes	yes	yes	yes
Interrupts	yes, parameterizable	yes, parameterizable	no	no
Process alarm	yes, parameterizable	yes, parameterizable	no	no
Diagnostic interrupt	yes, parameterizable	yes, parameterizable	no	no
Diagnostic functions	yes, parameterizable	yes, parameterizable	no	no
Diagnostics information read-out	possible	possible	none	possible
Supply voltage display	green LED	green LED	green LED	yes
Service Indicator	-	-	-	-
Group error display	red SF LED	red SF LED	red LED	red LED
Channel error display	none	none	none	none
Hardware configuration				
Racks, max.	1	1	1	1
Modules per rack, max.	32	8	16	32
Number of digital modules, max.	32	8	16	32
Number of analog modules, max.	16	8	4	16

SLIO
100V
200V
300S
500S
HMI
Teleservice
StarterKits
Safety
Solutions
Software
Accessories
Appendix

Interface modules Fieldbus slave modules without I/Os					
253-1CA01	253-1DP11				
253-1CA30	253-1DP31				
253-1DN00	253-1IB00				
253-1DP01	253-1NE00				

Order number	253-1DP11	253-1DP31	253-1IB00	253-1NE00
Communication				
Fieldbus	PROFIBUS-DP to EN 50170	PROFIBUS-DP to EN 50170	INTERBUS-S to DIN 19258	Ethernet MODBUS/TCP and Siemens S5 Header
Type of interface	FOC	RS485	RS422	Ethernet 10/100 MBit
Connector	2-pin FOC POF/HCS	Sub-D, 9-pin, female	Sub-D, 9-pin, male (in) and female (out)	RJ45
Topology	Line structure with two-wire FOC	Linear bus with bus termination at both ends	Ring with integrated return line	Star topology
Electrically isolated	✓	✓	✓	✓
Number of participants, max.	125	125	256	8
Node addresses	1 - 99	1 - 125	-	IP V4 address
Transmission speed, min.	9.6 kbit/s	9.6 kbit/s	-	10 Mbit/s
Transmission speed, max.	12 Mbit/s	12 Mbit/s	500 kbit/s	100 Mbit/s
Address range inputs, max.	244 Byte	244 Byte	20 Byte	256 Byte
Address range outputs, max.	244 Byte	244 Byte	20 Byte	256 Byte
Number of TxPDOs, max.	-	-	-	-
Number of RxPDOs, max.	-	-	-	-
Housing				
Material	PPE / PA 6.6	PPE / PA 6.6	PPE / PA 6.6	PPE / PA 6.6
Mounting	Profile rail 35 mm	Profile rail 35 mm	Profile rail 35 mm	Profile rail 35 mm
Mechanical data				
Dimensions (WxHxD)	25.4 mm x 76 mm x 78 mm	25.4 mm x 76 mm x 78 mm	25.4 mm x 76 mm x 78 mm	25.4 mm x 76 mm x 78 mm
Weight	110 g	90 g	100 g	90 g
Environmental conditions				
Operating temperature	0 °C to 60 °C	0 °C to 60 °C	0 °C to 60 °C	0 °C to 60 °C
Storage temperature	-25 °C to 70 °C	-25 °C to 70 °C	-25 °C to 70 °C	-25 °C to 70 °C
Certifications				
UL508 certification	yes	yes	yes	yes

Connections, Interfaces

Interface modules | Fieldbus slave modules without I/Os

253-1CA01
253-1CA30
253-1DN00
253-1DP01

253-1DP11
253-1DP31
253-1IB00
253-1NE00

253-1DP11

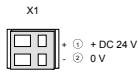
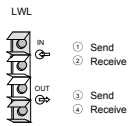

253-1DP31

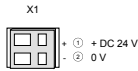
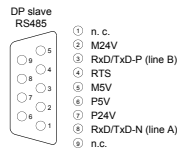

253-1IB00

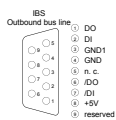
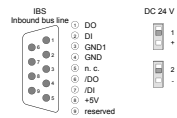

253-1NE00

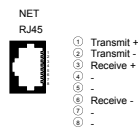

200V accessories



Structure and Function

System accessories expand the use of the system and facilitate starting.

Note: Front connectors and label strips are supplied with the modules.

Memory Extension

MMC cards can be used to store program and data.

Bus Connectors

By using backplane bus connectors, communication between the modules is realized. The backplane bus connectors are insulated and available in various designs (1, 2, 4 or 8 times width).

35 mm Profile Rail

With the help of 35 mm profile rails, the respective modules can be mounted directly on the mounting surface. The profile rail is can be ordered in various lengths.

Front Connectors

The front connectors are supplied with the CPU and signal modules, but can also be ordered separately as spare parts.

Manuals

The technical documentation of the respective modules encompasses various manuals with the necessary hardware and programming information, detailed descriptions of each module, and instructions for structure and assembly.

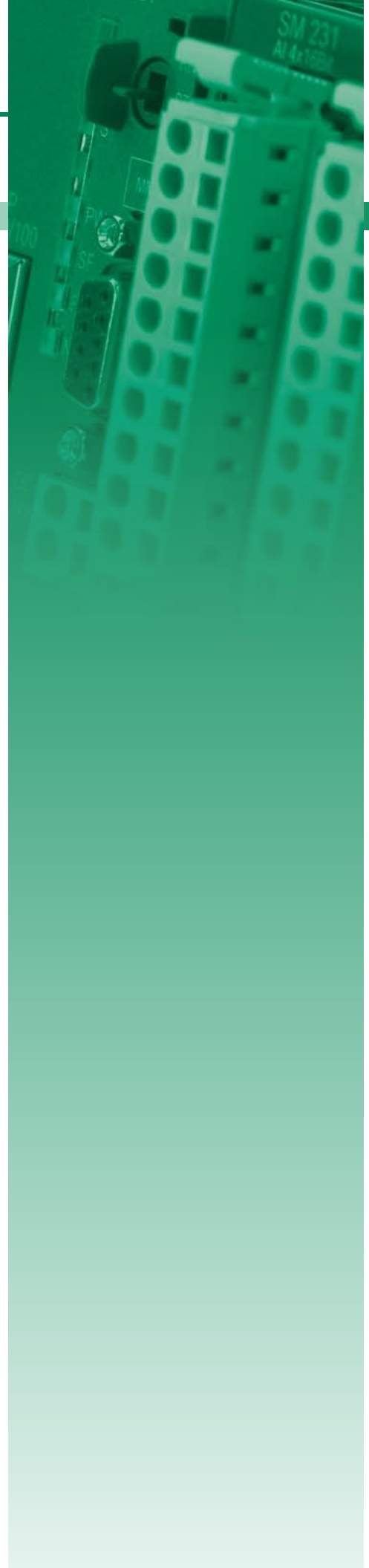

Bus connectors

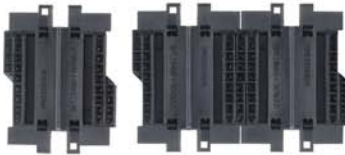

Order number	Type	Description	Note
290-0AA10	Bus connector	1-tier	
290-0AA20	Bus connector	2-tier	
290-0AA40	Bus connector	4-tier	
290-0AA80	Bus connector	8-tier	

35 mm profile rail



Order number	Type	Description	Note
290-1AF00	35 mm profile rail	length 2000 mm	
290-1AF30	35 mm profile rail	length 530 mm	

Front connector



Order number	Type	Description	Note
292-1AF00	Front connector	10 pin with cage clamps (included in the scope of delivery of signal modules)	
292-1AH00	Front connector	18 pin with cage clamps (included in the scope of delivery of signal modules)	

Cables



Order number	Type	Description	Note
260-1XY05	Connection cable	Connection cable for interface modules, length 0.5 m	
260-1XY10	Connection cable	Connection cable for interface modules, length 1.0 m	
260-1XY20	Connection cable	Connection cable for interface modules, length 2.0 m	
260-1XY25	Connection cable	Connection cable for interface modules, length 2.5 m	

Antennas, connectors etc.



Order number	Type	Description	Note
970-0CM00	CM 240 - Jack	For communication processor CM 240 - mini switch, external DC 24 V power supply	
970-0DN00	CM 240 - Jack	For communication processor CM 240 - mini switch, external DC 24 V power supply	
240-0EA00	CP 240 - Portable Antenna	EnOcean Antenna portable, incl. SMA connector	
240-0EA10	CP 240 - Magnetic base antenna	EnOcean Antenna magnetic base, incl. 150 cm cable and SMA connector	

MMC memory



Order number	Type	Description	Note
953-0KX10	MMC - MultiMediaCard	Extension memory for VIPA CPUs 11x, 21x, 24x, 31x, 51x, and 208-1DP01, CC 03 (for load memory not necessary)	

Labelling

Order number	Type	Description	Note
292-1XY10	Labelling cards	I/O labelling, perforated, 10 sheets each 8 cards	
292-1XY20	Clip-on cards	Module labelling, perforated, 10 sheets each 108 cards	
292-1XY00	Labelling cards	I/O labelling, with transparent cover foil, 10 pieces	

Manuals and operating instructions



Order number	Title	Contents	Language
HB97D	Manual System 200V - Compendium, German	HB97D_PS-CM, HB97D_SM, HB97D_CP, HB97D_IM, HB97D_FM	DE
HB97E	Manual System 200V - Compendium, English	HB97E_PS-CM, HB97E_SM, HB97E_CP, HB97E_IM, HB97E_FM	EN
HB97D_CP	Manual System 200V - German	CP 240 Communication processors	DE
HB97E_CP	Manual System 200V - English	CP 240 Communication processors	EN
HB97D_CPU	Manual System 200V - German	CPU 21x, incl. operations list	DE
HB97E_CPU	Manual System 200V - English	CPU 21x, incl. operations list	EN
HB99D_CPU	Manual System 200V - German	CPU 24x, incl. operations list	DE
HB99E_CPU	Manual System 200V - English	CPU 24x, incl. operations list	EN
HB97D_FM	Manual System 200V - German	FM - Function modules	DE
HB97E_FM	Manual System 200V - English	FM - Function modules	EN
HB97D_IM	Manual System 200V - German	IM - Interface modules	DE
HB97E_IM	Manual System 200V - English	IM - Interface modules	EN
HB97D_PS-CM	Manual System 200V - German	PS-CM - Power supply / Expansion modules	DE
HB97E_PS-CM	Manual System 200V - English	PS-CM - Power supply / Expansion modules	EN
HB97E_SM-AIO	Manual System 200V - English	SM-AIO - Analog Signal modules	EN

At a glance

System description 300S	412
CPUs	414
Power supply	478
Signal modules digital	484
Signal modules analog	504
Communication processors	526
Interface modules	542
300S accessories	548



| 300S

System description 300S

Structure and Concept

300S is both a compact and a modular expandable system.

300S is designed for centralized and decentralized automation tasks in the manufacturing and process industry up to the highest power range.

With a central extension of up to 32 modules directly to the CPU and up to 126 fieldbus slave modules, it is deployable almost anywhere. The module size allows use in almost any automation environment.

The assembly is extremely simple. First, the backplane bus connectors for communication between the modules and the CPU are entered from behind and then the modules are individually placed and secured on the rail and screwed down.

The backplane bus connectors are supplied with the I/O modules. In the SPEED-Bus, the bus connection takes place via a SPEED-Bus terminal strip (PCB) integrated in the profile rail. The SPEED-Bus modules are mounted on the left of the CPU - depending on bus length 2, 6 or 10 SPEED-Bus modules can be deployed.



Performance and Application

300S is designed for centralized and decentralized automation tasks. The integrated SPEED7 ASIC system 300S is among the world's fastest automation systems. A wide range of CPU options makes the system universally deployable. The selection ranges from C-class CPUs with integrated I/O peripherals for smaller applications up to CPU versions with built-in Ethernet, fieldbus master interfaces, and High-Speed-Bus.

The CPU versions with integrated SPEED-Bus have been especially developed for automation tasks with very high demands on performance. Furthermore special high-speed modules for communication and for digital as well as analog signal processing are available.

Programming

300S is programmed with VIPA WinPLC7 or with Siemens STEP7 in LAD, FBD and STL or with Siemens TIA Portal .

Memory

The CPUs in 300S have the work and load memory already integrated. Depending on the CPU variant different work memory are available for the user. The work and load memory can be adapted to the needs of memory card by plugging in an MCC memory expansion card. To back up program and data standard MMC cards are also supported.

Functions

For the connection of sensors and actuators, a variety of signal modules are available for recording digital and analog signals into and out of the process is available - also as high-speed modules for SPEED-Bus.

Measurements and the control of pressures, temperatures, flow rates and levels are realized at the highest level with the measurement and control modules.

Communication

An Ethernet programming interface is integrated on all CPUs in system 300S. Ethernet communication processors link 300S horizontally and vertically into network structures. Therefore, all relevant data are made available to the connected host systems.

300S offers fieldbus master and slave modules with different fieldbus protocols and can act as a master controller or as a subordinate fieldbus slave unit.

Multi-master applications with very high performance of communication can be implemented via the fieldbus master module for SPEED-Bus.

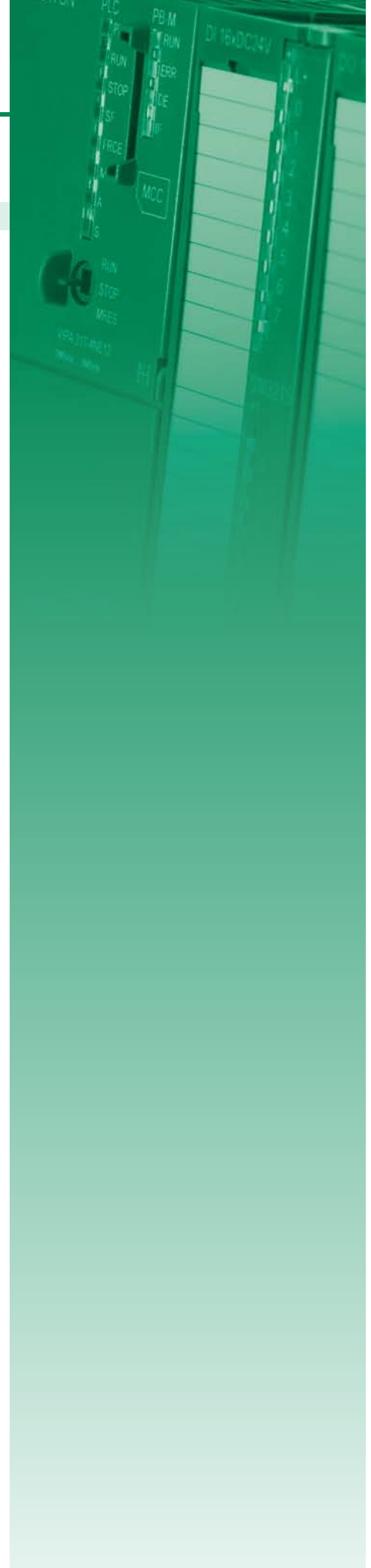

CPUs

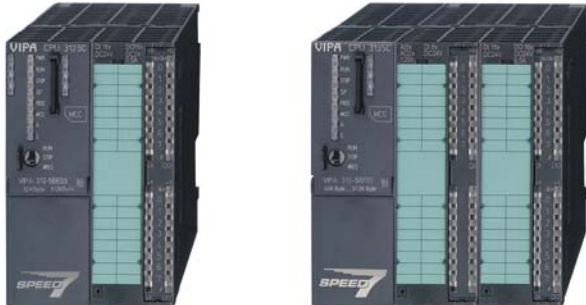

CPUs-Central Modules

Central Processing Units (CPU) control and regulate processes in plant and machinery. The CPUs are selected according to application with the appropriate performance and work memory and can be extended with signal and function modules, as well as communication processors.

The System 300S CPUs are designed command compatible to Siemens STEP7 and for medium and large applications.

The CPUs are based on the SPEED7 technology. Here, the CPU is supported by co-processors. The integrated SPEED7 ASIC system is among the world's fastest automation systems.

A wide range of CPU options makes the system universally deployable: From C-class CPUs with integrated I/O peripherals for smaller applications up to CPU versions with integrated Ethernet, fieldbus master interfaces, and high-speed bus.

The CPUs of System 300S make possible short machine cycle times due to their high processing speed, and are therefore particularly suitable for complex control and automation tasks in the manufacturing and process industries. The compact CPUs with integrated I/Os are designed especially for cost-sensitive applications.

Characteristics

- › High-speed control system
- › Programmable with WinPLC7 or Siemens STEP7
- › Integrated work memory, operation without a memory card
- › Integrated accumulator-backed RAM memory
- › Flexible work memory extension through MCC memory extension card
- › Support of MMC cards for saving of program and data
- › SPEED-Bus for extension with high-speed signal modules and communication processors (CPU 314ST, 317SE, 317SN and 317PN)
- › Ethernet, PROFIBUS-DP and MPI interfaces on board
- › PROFIBUS-DP master/DP slave or PtP (switchable)
- › Centralized and decentralized use and modular extendable
- › Integrated real-time clock and front-integrated status LEDs
- › 24 month warranty

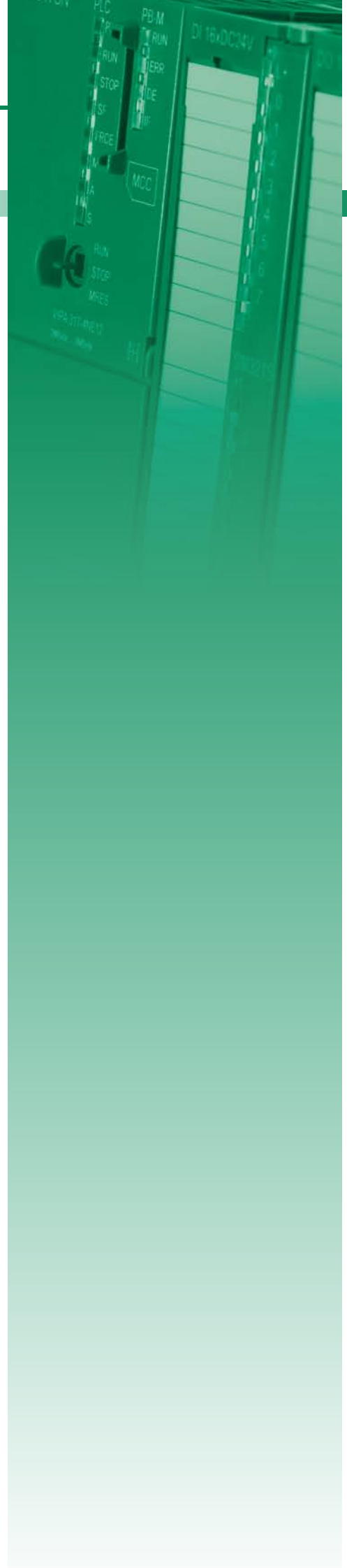

Overview

Order no.	Name/Description	Page
CPUs STEP7 programmable, standard		
314-2AG12	CPU 314SB/DPM - SPEED7 technology † SPEED7 technology † 256 kB work memory † Memory extension (max. 512 kB) † PROFIBUS-DP master / PtP (switchable)	418
314-2AG13	CPU 314SB/DPM - SPEED7 technology † SPEED7 technology † 256 kB work memory † Memory extension (max. 512 kB) † PROFIBUS-DP master / PtP (switchable) † Also configurable via TIA-Portal	418
314-2BG03	CPU 314SE/DPS - SPEED7 technology † SPEED7 technology † 128 kB work memory † Memory extension (max. 512 kB) † PROFIBUS-DP slave / PtP (switchable) † Also configurable via TIA-Portal	418
315-2AG12	CPU 315SB/DPM - SPEED7 technology † SPEED7 technology † 1 MB work memory † Memory extension (max. 2 MB) † PROFIBUS-DP master / PtP (switchable)	418
315-2AG13	CPU 315SB/DPM - SPEED7 technology † SPEED7 technology † 1 MB work memory † Memory extension (max. 2 MB) † PROFIBUS-DP master / PtP (switchable) † Also configurable via TIA-Portal	425
317-2AJ12	CPU 317SE/DPM - SPEED7 technology † SPEED7 technology, SPEED-Bus † 2 MB work memory † Memory extension (max. 8 MB) † PROFIBUS-DP master / PtP (switchable)	425
317-2AJ13	CPU 317SE/DPM - SPEED7 technology † SPEED7 technology, SPEED-Bus † 2 MB work memory † Memory extension (max. 8 MB) † PROFIBUS-DP master / PtP (switchable) † Also configurable via TIA-Portal	425
CPUs STEP7 programmable, NET-CPUs		
315-4NE12	CPU 315SN/NET - SPEED7 technology † SPEED7 technology † 1 MB work memory † Memory extension (max. 2 MB) † PROFIBUS-DP master / PtP (switchable) † CP 343 integrated	432
315-4NE13	CPU 315SN/NET - SPEED7 technology † SPEED7 technology † 1 MB work memory † Memory extension (max. 2 MB) † PROFIBUS-DP master / PtP (switchable) † CP 343 integrated † Also configurable via TIA-Portal	432
317-4NE12	CPU 317SN/NET - SPEED7 technology † SPEED7 technology, SPEED-Bus † 2 MB work memory † Memory extension (max. 8 MB) † PROFIBUS-DP master / PtP (switchable) † CP 343 integrated	432
317-4NE13	CPU 317SN/NET - SPEED7 technology † SPEED7 technology, SPEED-Bus † 2 MB work memory † Memory extension (max. 8 MB) † PROFIBUS-DP master / PtP (switchable) † CP 343 integrated † Also configurable via TIA-Portal	432

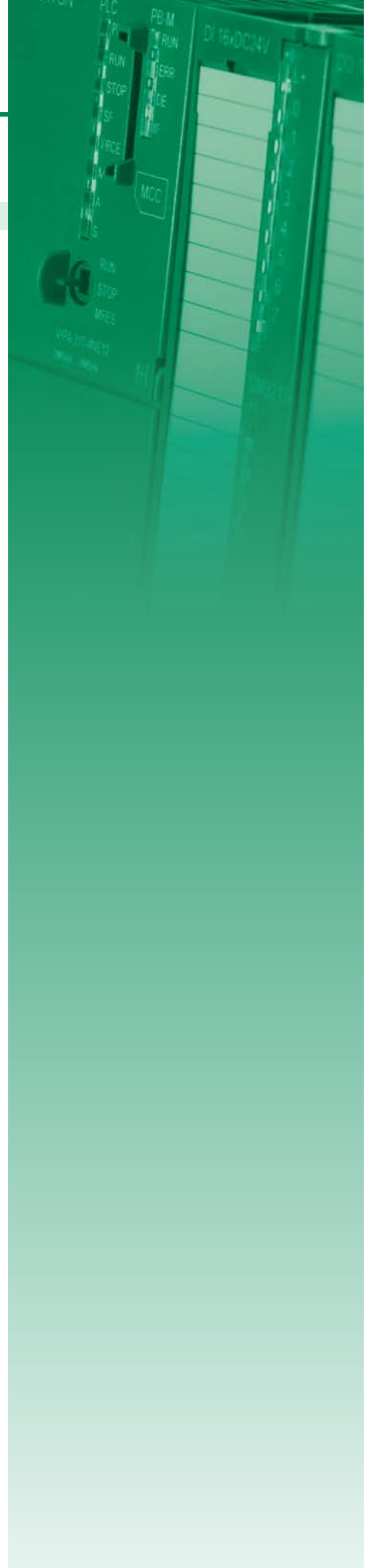

Overview

Order no.	Name/Description	Page
CPUs STEP7 programmable, PROFINET		
315-4PN12	CPU 315SN/PN - SPEED7 technology † SPEED7 technology † 1 MB work memory † Memory extension (max. 2 MB) † PROFIBUS-DP master / PtP (switchable) † PROFINET controller integrated † Also configurable via TIA-Portal	440
315-4PN33	CPU 315SN/PN ECO - SPEED7 technology † SPEED7 technology † 512 KB work memory † PtP † PROFINET controller integrated † Also configurable via TIA-Portal	440
317-4PN12	CPU 317SN/PN - SPEED7 technology † SPEED7 technology, SPEED-Bus † 2 MB work memory † Memory extension (max. 8 MB) † PROFIBUS-DP master / PtP (switchable) † PROFINET Controller integrated † Also configurable via TIA-Portal	440
CPUs STEP7 programmable, class C		
312-5BE13	CPU 312SC - SPEED7 technology † SPEED7 technology † 16 x DI, 8 x DO † 64 kB work memory † Memory extension (max. 512 kB) † PtP interface † Also configurable via TIA-Portal	449
313-5BF13	CPU 313SC - SPEED7 technology † SPEED7 technology † 24 x DI, 16 x DO, 4 x AI, 2 x AO, 1 x AI Pt100 † 128 kB work memory † Memory extension (max. 512 kB) † PtP interface † Also configurable via TIA-Portal	449
313-6CF13	CPU 313SC/DPM - SPEED7 technology † SPEED7 technology † 16 x DI, 16 x DO † 128 kB work memory † Memory extension (max 512 kB) † PROFIBUS-DP master / PtP (switchable) † Also configurable via TIA-Portal	449
314-6CF02	CPU 314ST/DPM - SPEED7 technology † SPEED7 technology, SPEED-Bus † 8 x DI, 8 x DO, 4 x AI, 2 x AO, 1 x AI Pt100 † 512 kB work memory † Memory extension (max. 2 MB) † PROFIBUS-DP master / PtP (switchable)	449
314-6CF03	CPU 314ST/DPM - SPEED7 technology † SPEED7 technology, SPEED-Bus † 8 x DI, 8 x DO, 4 x AI, 2 x AO, 1 x AI Pt100 † 512 kB work memory † Memory extension (max. 2 MB) † PROFIBUS-DP master / PtP (switchable) † Also configurable via TIA-Portal	460
314-6CG13	CPU 314SC/DPM - SPEED7 technology † SPEED7 technology † 24 x DI, 16 x DO, 8 x DIO, 4 x AI, 1 x AI Pt100, 2 x AO † 256 kB work memory † Memory extension (max. 1 MB) † PROFIBUS-DP master / PtP (switchable) † Also configurable via TIA-Portal	460

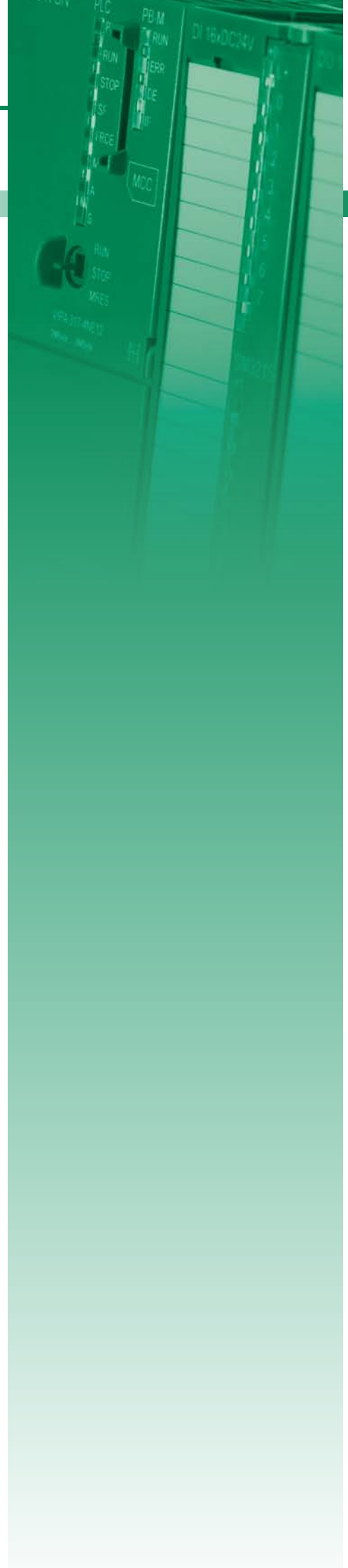

Overview

Order no.	Name/Description	Page
CPUs STEP7 programmable, EtherCAT		
315-4EC12	CPU 315SN/NET - SPEED7 technology <ul style="list-style-type: none"> › SPEED7 technology › 1 MB work memory › Memory extension (max. 2 MB) › PROFIBUS-DP master / PtP (switchable) › EtherCAT controller integrated 	470
317-4EC12	CPU 317SN/NET - SPEED7 technology <ul style="list-style-type: none"> › SPEED7 technology, SPEED-Bus › 2 MB work memory › Memory extension (max. 8 MB) › PROFIBUS-DP master / PtP (switchable) › EtherCAT-Master integrated 	470



CPUs STEP7 programmable, standard

CPUs CPUs STEP7 programmable, standard					
314-2AG12	315-2AG13				
314-2AG13	317-2AJ12				
314-2BG03	317-2AJ13				
315-2AG12					

Order number	314-2AG12	314-2AG13	314-2BG03	315-2AG12
Figure				
Type	CPU 314SB/DPM	CPU 314SB/DPM	CPU 314SE/DPS	CPU 315SB/DPM
General information				
Note	-	-	-	-
Features	<ul style="list-style-type: none"> ▶ SPEED7 technology ▶ 256 kB work memory ▶ Memory extension (max. 512 kB) ▶ PROFIBUS-DP master / PtP (switchable) 	<ul style="list-style-type: none"> ▶ SPEED7 technology ▶ 256 kB work memory ▶ Memory extension (max. 512 kB) ▶ PROFIBUS-DP master / PtP (switchable) ▶ Also configurable via TIA-Portal 	<ul style="list-style-type: none"> ▶ SPEED7 technology ▶ 128 kB work memory ▶ Memory extension (max. 512 kB) ▶ PROFIBUS-DP slave / PtP (switchable) ▶ Also configurable via TIA-Portal 	<ul style="list-style-type: none"> ▶ SPEED7 technology ▶ 1 MB work memory ▶ Memory extension (max. 2 MB) ▶ PROFIBUS-DP master / PtP (switchable)
SPEED-Bus	-	-	-	-
Technical data power supply				
Power supply (rated value)	DC 24 V	DC 24 V	DC 24 V	DC 24 V
Power supply (permitted range)	DC 20.4...28.8 V	DC 20.4...28.8 V	DC 20.4...28.8 V	DC 20.4...28.8 V
Reverse polarity protection	✓	✓	✓	✓
Current consumption (no-load operation)	200 mA	200 mA	180 mA	200 mA
Current consumption (rated value)	1 A	1 A	900 mA	1 A
Inrush current	5 A	5 A	8 A	5 A
I²t	0.5 A²s	0.5 A²s	0.7 A²s	0.5 A²s
Max. current drain at backplane bus	2.5 A	2.5 A	3 A	2.5 A
Power loss	6 W	6 W	6 W	6 W
Load and working memory				
Load memory, integrated	512 KB	512 KB	512 KB	2 MB
Load memory, maximum	512 KB	512 KB	512 KB	2 MB
Work memory, integrated	256 KB	256 KB	128 KB	1 MB
Work memory, maximal	512 KB	512 KB	512 KB	2 MB
Memory divided in 50% program / 50% data	✓	✓	✓	✓
Memory card slot	MMC-Card with max. 1 GB	MMC-Card with max. 1 GB	MMC-Card with max. 1 GB	MMC-Card with max. 1 GB
Hardware configuration				
Racks, max.	4	4	4	4
Modules per rack, max.	8 in multiple-, 32 in a single-rack configuration	8 in multiple-, 32 in a single-rack configuration	8 in multiple-, 32 in a single-rack configuration	8 in multiple-, 32 in a single-rack configuration
Number of integrated DP master	1	1	-	1
Number of DP master via CP	4	4	4	4
Operable function modules	8	8	8	8
Operable communication modules PtP	8	8	8	8
Operable communication modules LAN	8	8	8	8

SLIO
100V
200V
300S
500S
HMI
Teleservice
StarterKits
Safety
Solutions
Software
Accessories
Appendix

CPUs CPUs STEP7 programmable, standard					
314-2AG12	315-2AG13				
314-2AG13	317-2AJ12				
314-2BG03	317-2AJ13				
315-2AG12					

Order number	314-2AG12	314-2AG13	314-2BG03	315-2AG12
Command processing times				
Bit instructions, min.	0.01 µs	0.01 µs	0.02 µs	0.01 µs
Word instruction, min.	0.01 µs	0.01 µs	0.02 µs	0.01 µs
Double integer arithmetic, min.	0.01 µs	0.01 µs	0.02 µs	0.01 µs
Floating-point arithmetic, min.	0.06 µs	0.06 µs	0.12 µs	0.06 µs
Timers/Counters and their retentive characteristics				
Number of S7 counters	512	512	512	512
S7 counter remanence	adjustable 0 up to 512	adjustable 0 up to 512	adjustable 0 up to 256	adjustable 0 up to 512
S7 counter remanence adjustable	C0 .. C7	C0 .. C7	C0 .. C7	C0 .. C7
Number of S7 times	512	512	512	512
S7 times remanence	adjustable 0 up to 512	adjustable 0 up to 512	adjustable 0 up to 256	adjustable 0 up to 512
S7 times remanence adjustable	not retentive	not retentive	not retentive	not retentive
Data range and retentive characteristic				
Number of flags	8192 Byte	8192 Byte	8192 Byte	8192 Byte
Bit memories retentive characteristic adjustable	adjustable 0 up to 8192	adjustable 0 up to 8192	adjustable 0 up to 2048	adjustable 0 up to 8192
Bit memories retentive characteristic preset	MB0 .. MB15	MB0 .. MB15	MB0 .. MB15	MB0 .. MB15
Number of data blocks	4095	4095	4095	4095
Max. data blocks size	64 KB	64 KB	64 KB	64 KB
Number range DBs	1 ... 4095	1 ... 4095	1 ... 4095	1 ... 4095
Max. local data size per execution level	510 Byte	1024 Byte	1024 Byte	510 Byte
Max. local data size per block	510 Byte	1024 Byte	1024 Byte	510 Byte
Blocks				
Number of OBs	24	23	15	24
Maximum OB size	64 KB	64 KB	64 KB	64 KB
Total number DBs, FBs, FCs	-	-	-	-
Number of FBs	2048	2048	2048	2048
Maximum FB size	64 KB	64 KB	64 KB	64 KB
Number range FBs	0 ... 2047	0 ... 2047	0 ... 2047	0 ... 2047
Number of FCs	2048	2048	2048	2048
Maximum FC size	64 KB	64 KB	64 KB	64 KB
Number range FC2	0 ... 2047	0 ... 2047	0 ... 2047	0 ... 2047
Maximum nesting depth per priority class	8	8	8	8
Maximum nesting depth additional within an error OB	4	4	4	4
Time				
Real-time clock buffered	✓	✓	✓	✓
Clock buffered period (min.)	6 w	6 w	6 w	6 w
Type of buffering	-	-	-	-
Load time for 50% buffering period	20 h	20 h	20 h	20 h
Load time for 100% buffering period	48 h	48 h	48 h	48 h
Accuracy (max. deviation per day)	10 s	10 s	10 s	10 s
Number of operating hours counter	8	8	8	8
Clock synchronization	✓	✓	✓	✓
Synchronization via MPI	Master/Slave	Master/Slave	Master/Slave	Master/Slave
Synchronization via Ethernet (NTP)	no	no	no	no

SLIO
100V
200V
300S
500S
HMI
Teleservice
StarterKits
Safety
Solutions
Software
Accessories
Appendix

CPUs CPUs STEP7 programmable, standard					
314-2AG12	315-2AG13				
314-2AG13	317-2AJ12				
314-2BG03	317-2AJ13				
315-2AG12					

Order number	314-2AG12	314-2AG13	314-2BG03	315-2AG12
Address areas (I/O)				
Input I/O address area	8192 Byte	8192 Byte	2048 Byte	8192 Byte
Output I/O address area	8192 Byte	8192 Byte	2048 Byte	8192 Byte
Process image adjustable	✓	✓	-	✓
Input process image preset	256 Byte	256 Byte	128 Byte	256 Byte
Output process image preset	256 Byte	256 Byte	128 Byte	256 Byte
Input process image maximal	2048 Byte	2048 Byte	128 Byte	2048 Byte
Output process image maximal	2048 Byte	2048 Byte	128 Byte	2048 Byte
Digital inputs	65536	65536	16384	65536
Digital outputs	65536	65536	16385	65536
Digital inputs central	1024	1024	1024	1024
Digital outputs central	1024	1024	1024	1024
Integrated digital inputs	-	-	-	-
Integrated digital outputs	-	-	-	-
Analog inputs	4096	4096	1024	4096
Analog outputs	4096	4096	1024	4096
Analog inputs, central	256	256	256	256
Analog outputs, central	256	256	256	256
Integrated analog inputs	-	-	-	-
Integrated analog outputs	-	-	-	-
Communication functions				
PG/OP channel	✓	✓	✓	✓
Global data communication	✓	✓	✓	✓
Number of GD circuits, max.	8	8	8	8
Size of GD packets, max.	54 Byte	54 Byte	22 Byte	54 Byte
S7 basic communication	✓	✓	✓	✓
S7 basic communication, user data per job	76 Byte	76 Byte	76 Byte	76 Byte
S7 communication	✓	✓	✓	✓
S7 communication as server	✓	✓	✓	✓
S7 communication as client	-	-	-	-
S7 communication, user data per job	160 Byte	160 Byte	160 Byte	160 Byte
Number of connections, max.	32	32	32	32
Functionality Sub-D interfaces				
Type	X2	X2	X2	X2
Type of interface	RS485	RS485	RS485	RS485
Connector	Sub-D, 9-pin, female	Sub-D, 9-pin, female	Sub-D, 9-pin, female	Sub-D, 9-pin, female
Electrically isolated	✓	✓	-	✓
MPI	✓	✓	✓	✓
MP2 ¹ (MPI/RS232)	-	-	-	-
DP master	-	-	-	-
DP slave	-	-	-	-
Point-to-point interface	-	-	-	-

SLIO
100V
200V
300S
500S
HMI
Teleservice
StarterKits
Safety
Solutions
Software
Accessories
Appendix

CPUs CPUs STEP7 programmable, standard						
314-2AG12	315-2AG13					
314-2AG13	317-2AJ12					
314-2BG03	317-2AJ13					
315-2AG12						

Order number	314-2AG12	314-2AG13	314-2BG03	315-2AG12
Type	X3	X3	X3	X3
Type of interface	RS485	RS485	RS485	RS485
Connector	Sub-D, 9-pin, female	Sub-D, 9-pin, female	Sub-D, 9-pin, female	Sub-D, 9-pin, female
Electrically isolated	✓	✓	✓	✓
MPI	-	-	-	-
MP ² I (MPI/RS232)	-	-	-	-
DP master	yes	yes	-	yes
DP slave	yes	yes	yes	yes
Point-to-point interface	✓	✓	✓	✓
Functionality MPI				
Number of connections, max.	32	32	32	32
PG/OP channel	✓	✓	✓	✓
Routing	✓	✓	-	✓
Global data communication	✓	✓	✓	✓
S7 basic communication	✓	✓	✓	✓
S7 communication	✓	✓	✓	✓
S7 communication as server	✓	✓	✓	✓
S7 communication as client	-	-	-	-
Transmission speed, min.	19.2 kbit/s	19.2 kbit/s	19.2 kbit/s	19.2 kbit/s
Transmission speed, max.	12 Mbit/s	12 Mbit/s	187.5 kbit/s	12 Mbit/s
Functionality PROFIBUS master				
PG/OP channel	✓	✓	-	✓
Routing	✓	✓	-	✓
S7 basic communication	✓	✓	-	✓
S7 communication	✓	✓	-	✓
S7 communication as server	✓	✓	-	✓
S7 communication as client	-	-	-	-
Activation/deactivation of DP slaves	✓	✓	-	✓
Direct data exchange (slave-to-slave communication)	-	-	-	-
DPV1	✓	✓	-	✓
Transmission speed, min.	9.6 kbit/s	9.6 kbit/s	-	9.6 kbit/s
Transmission speed, max.	12 Mbit/s	12 Mbit/s	-	12 Mbit/s
Number of DP slaves, max.	124	124	-	124
Address range inputs, max.	8 KB	8 KB	-	8 KB
Address range outputs, max.	8 KB	8 KB	-	8 KB
User data inputs per slave, max.	244 Byte	244 Byte	-	244 Byte
User data outputs per slave, max.	244 Byte	244 Byte	-	244 Byte
Functionality PROFIBUS slave				
PG/OP channel	✓	✓	-	✓
Routing	✓	✓	-	✓
S7 communication	✓	✓	-	✓
S7 communication as server	✓	✓	-	✓
S7 communication as client	-	-	-	-

CPU CPU STEP7 programmable, standard					
314-2AG12	315-2AG13				
314-2AG13	317-2AJ12				
314-2BG03	317-2AJ13				
315-2AG12					

Order number	314-2AG12	314-2AG13	314-2BG03	315-2AG12
Direct data exchange (slave-to-slave communication)	-	-	-	-
DPV1	✓	✓	✓	✓
Transmission speed, min.	9.6 kbit/s	9.6 kbit/s	9.6 kbit/s	9.6 kbit/s
Transmission speed, max.	12 Mbit/s	12 Mbit/s	12 Mbit/s	12 Mbit/s
Automatic detection of transmission speed	-	-	-	-
Transfer memory inputs, max.	244 Byte	244 Byte	244 Byte	244 Byte
Transfer memory outputs, max.	244 Byte	244 Byte	244 Byte	244 Byte
Address areas, max.	32	32	32	32
User data per address area, max.	32 Byte	32 Byte	32 Byte	32 Byte
Point-to-point communication				
PtP communication	✓	✓	✓	✓
Interface isolated	✓	✓	✓	✓
RS232 interface	-	-	-	-
RS422 interface	-	-	-	-
RS485 interface	✓	✓	✓	✓
Connector	Sub-D, 9-pin, female	Sub-D, 9-pin, female	Sub-D, 9-pin, female	Sub-D, 9-pin, female
Transmission speed, min.	150 bit/s	150 bit/s	150 bit/s	150 bit/s
Transmission speed, max.	115.5 kbit/s	115.5 kbit/s	115.5 kbit/s	115.5 kbit/s
Cable length, max.	500 m	500 m	500 m	500 m
Point-to-point protocol				
ASCII protocol	✓	✓	✓	✓
STX/ETX protocol	✓	✓	✓	✓
3964(R) protocol	✓	✓	✓	✓
RK512 protocol	-	-	-	-
USS master protocol	✓	✓	✓	✓
Modbus master protocol	✓	✓	✓	✓
Modbus slave protocol	-	-	-	-
Special protocols	-	-	-	-
Functionality RJ45 interfaces				
Type	X4	X4	X4	X4
Type of interface	Ethernet 10/100 MBit	Ethernet 10/100 MBit	Ethernet 10/100 MBit	Ethernet 10/100 MBit
Connector	RJ45	RJ45	RJ45	RJ45
Electrically isolated	✓	✓	✓	✓
PG/OP channel	✓	✓	✓	✓
Number of connections, max.	4	4	4	4
Productive connections	-	-	-	-
Housing				
Material	PPE	PPE	PPE	PPE
Mounting	Rail System 300	Rail System 300	Rail System 300	Rail System 300
Mechanical data				
Dimensions (WxHxD)	40 mm x 125 mm x 120 mm	40 mm x 125 mm x 120 mm	40 mm x 125 mm x 120 mm	40 mm x 125 mm x 120 mm
Weight	290 g	290 g	235 g	290 g
Environmental conditions				
Operating temperature	0 °C to 60 °C	0 °C to 60 °C	0 °C to 60 °C	0 °C to 60 °C
Storage temperature	-25 °C to 70 °C	-25 °C to 70 °C	-25 °C to 70 °C	-25 °C to 70 °C
Certifications				
UL508 certification	in preparation	yes	yes	yes

SLIO
100V
200V
300S
500S
HMI
Teleservice
StarterKits
Safety
Solutions
Software
Accessories
Appendix
422

Connections, Interfaces

CPUs | CPU STEP7 programmable, standard

314-2AG12
314-2AG13
314-2BG03
315-2AG12

315-2AG13
317-2AJ12
317-2AJ13

314-2AG12



- + ① + DC 24 V
- ② 0 V



- ① Transmit +
- ② Transmit -
- ③ Receive +
- ④ -
- ⑤ -
- ⑥ Receive -
- ⑦ -
- ⑧ -

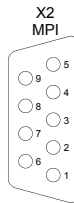

- ① n. c.
- ② M24V
- ③ RxD/TxD-P (line B)
- ④ RTS
- ⑤ M5V
- ⑥ P5V
- ⑦ P24V
- ⑧ RxD/TxD-N (line A)
- ⑨ n.c.

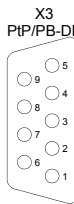

- ① shield
- ② M24V
- ③ RxD/TxD-P (line B)
- ④ RTS
- ⑤ M5V
- ⑥ P5V
- ⑦ P24V
- ⑧ RxD/TxD-N (line A)
- ⑨ n.c.

314-2AG13



- + ① + DC 24 V
- ② 0 V



- ① Transmit +
- ② Transmit -
- ③ Receive +
- ④ -
- ⑤ -
- ⑥ Receive -
- ⑦ -
- ⑧ -



- ① n. c.
- ② M24V
- ③ RxD/TxD-P (line B)
- ④ RTS
- ⑤ M5V
- ⑥ P5V
- ⑦ P24V
- ⑧ RxD/TxD-N (line A)
- ⑨ n.c.

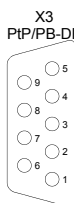

- ① shield
- ② M24V
- ③ RxD/TxD-P (line B)
- ④ RTS
- ⑤ M5V
- ⑥ P5V
- ⑦ P24V
- ⑧ RxD/TxD-N (line A)
- ⑨ n.c.

CPU | CPUs STEP7 programmable, standard

314-2AG12	315-2AG13				
314-2AG13	317-2AJ12				
314-2BG03	317-2AJ13				
315-2AG12					

314-2BG03

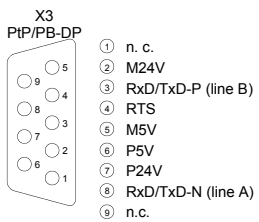
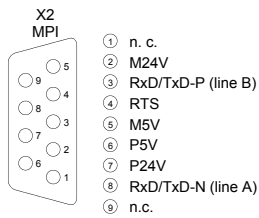
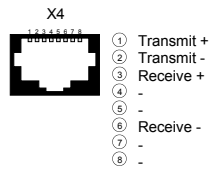
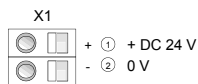

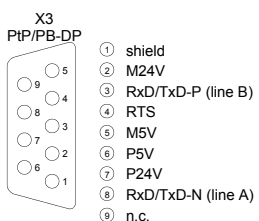
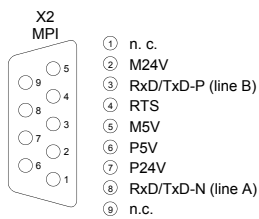
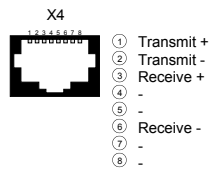
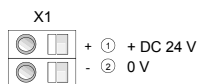

315-2AG12



CPUs STEP7 programmable, standard

CPUs CPUs STEP7 programmable, standard						
314-2AG12	315-2AG13					
314-2AG13	317-2AJ12					
314-2BG03	317-2AJ13					
315-2AG12						

Order number	315-2AG13	317-2AJ12	317-2AJ13	
Figure				
Type	CPU 315SB/DPM	CPU 317SE/DPM	CPU 317SE/DPM	
General information				
Note	-	-	-	
Features	<ul style="list-style-type: none"> ▶ SPEED7 technology ▶ 1 MB work memory ▶ Memory extension (max. 2 MB) ▶ PROFIBUS-DP master / PtP (switchable) ▶ Also configurable via TIA-Portal 	<ul style="list-style-type: none"> ▶ SPEED7 technology, SPEED-Bus ▶ 2 MB work memory ▶ Memory extension (max. 8 MB) ▶ PROFIBUS-DP master / PtP (switchable) 	<ul style="list-style-type: none"> ▶ SPEED7 technology, SPEED-Bus ▶ 2 MB work memory ▶ Memory extension (max. 8 MB) ▶ PROFIBUS-DP master / PtP (switchable) ▶ Also configurable via TIA-Portal 	
SPEED-Bus	-	✓	✓	
Technical data power supply				
Power supply (rated value)	DC 24 V	DC 24 V	DC 24 V	
Power supply (permitted range)	DC 20.4...28.8 V	DC 20.4...28.8 V	DC 20.4...28.8 V	
Reverse polarity protection	✓	✓	✓	
Current consumption (no-load operation)	200 mA	200 mA	200 mA	
Current consumption (rated value)	1 A	1.5 A	1.5 A	
Inrush current	5 A	5 A	5 A	
I ² t	0.5 A ² s	0.5 A ² s	0.5 A ² s	
Max. current drain at backplane bus	2.5 A	4 A	4 A	
Power loss	6 W	6.5 W	6.5 W	
Load and working memory				
Load memory, integrated	2 MB	8 MB	8 MB	
Load memory, maximum	2 MB	8 MB	8 MB	
Work memory, integrated	1 MB	2 MB	2 MB	
Work memory, maximal	2 MB	8 MB	8 MB	
Memory divided in 50% program / 50% data	✓	✓	✓	
Memory card slot	MMC-Card with max. 1 GB	MMC-Card with max. 1 GB	MMC-Card with max. 1 GB	
Hardware configuration				
Racks, max.	4	4	4	
Modules per rack, max.	8 in multiple-, 32 in a single-rack configuration	8 in multiple-, 32 in a single-rack configuration	8 in multiple-, 32 in a single-rack configuration	
Number of integrated DP master	1	1	1	
Number of DP master via CP	4	4	4	
Operable function modules	8	8	8	
Operable communication modules PtP	8	16	16	
Operable communication modules LAN	8	8	8	

SLIO
100V
200V
300S
500S
HMI
Teleservice
StarterKits
Safety
Solutions
Software
Accessories
Appendix

CPUs CPU STEP7 programmable, standard						
314-2AG12	315-2AG13					
314-2AG13	317-2AJ12					
314-2BG03	317-2AJ13					
315-2AG12						

Order number	315-2AG13	317-2AJ12	317-2AJ13	
Command processing times				
Bit instructions, min.	0.01 µs	0.01 µs	0.01 µs	
Word instruction, min.	0.01 µs	0.01 µs	0.01 µs	
Double integer arithmetic, min.	0.01 µs	0.01 µs	0.01 µs	
Floating-point arithmetic, min.	0.06 µs	0.06 µs	0.06 µs	
Timers/Counters and their retentive characteristics				
Number of S7 counters	512	2048	2048	
S7 counter remanence	adjustable 0 up to 512	adjustable 0 up to 2048	adjustable 0 up to 2048	
S7 counter remanence adjustable	C0 .. C7	C0 .. C7	C0 .. C7	
Number of S7 times	512	2048	2048	
S7 times remanence	adjustable 0 up to 512	adjustable 0 up to 2048	adjustable 0 up to 2048	
S7 times remanence adjustable	not retentive	not retentive	not retentive	
Data range and retentive characteristic				
Number of flags	8192 Byte	16384 Byte	16384 Byte	
Bit memories retentive characteristic adjustable	adjustable 0 up to 8192	adjustable 0 up to 16.384	adjustable 0 up to 16.384	
Bit memories retentive characteristic preset	MB0 .. MB15	MB0 .. MB15	MB0 .. MB15	
Number of data blocks	4095	8190	8190	
Max. data blocks size	64 KB	64 KB	64 KB	
Number range DBs	1 ... 4095	1 ... 8190	1 ... 8190	
Max. local data size per execution level	1024 Byte	510 Byte	1024 Byte	
Max. local data size per block	1024 Byte	510 Byte	1024 Byte	
Blocks				
Number of OBs	23	24	23	
Maximum OB size	64 KB	64 KB	64 KB	
Totalnumber DBs, FBs, FCs	-	-	-	
Number of FBs	2048	8191	8191	
Maximum FB size	64 KB	64 KB	64 KB	
Number range FBs	0 ... 2047	0 ... 8190	0 ... 8190	
Number of FCs	2048	8191	8191	
Maximum FC size	64 KB	64 KB	64 KB	
Number range FC2	0 ... 2047	0 ... 8190	0 ... 8190	
Maximum nesting depth per priority class	8	16	16	
Maximum nesting depth additional within an error OB	4	4	4	
Time				
Real-time clock buffered	✓	✓	✓	
Clock buffered period (min.)	6 w	6 w	6 w	
Type of buffering	-	-	-	
Load time for 50% buffering period	20 h	20 h	20 h	
Load time for 100% buffering period	48 h	48 h	48 h	
Accuracy (max. deviation per day)	10 s	10 s	10 s	
Number of operating hours counter	8	8	8	
Clock synchronization	✓	✓	✓	
Synchronization via MPI	Master/Slave	Master/Slave	Master/Slave	
Synchronization via Ethernet (NTP)	no	no	no	

SLIO
100V
200V
300S
500S
HMI
Teleservice
StarterKits
Safety
Solutions
Software
Accessories
Appendix
426

CPU CPU STEP7 programmable, standard					
314-2AG12	315-2AG13				
314-2AG13	317-2AJ12				
314-2BG03	317-2AJ13				
315-2AG12					

Order number	315-2AG13	317-2AJ12	317-2AJ13	
Address areas (I/O)				
Input I/O address area	8192 Byte	8192 Byte	8192 Byte	
Output I/O address area	8192 Byte	8192 Byte	8192 Byte	
Process image adjustable	✓	✓	✓	
Input process image preset	256 Byte	256 Byte	256 Byte	
Output process image preset	256 Byte	256 Byte	256 Byte	
Input process image maximal	2048 Byte	8192 Byte	8192 Byte	
Output process image maximal	2048 Byte	8192 Byte	8192 Byte	
Digital inputs	65536	65536	65536	
Digital outputs	65536	65536	65536	
Digital inputs central	1024	1024	1024	
Digital outputs central	1024	1024	1024	
Integrated digital inputs	-	-	-	
Integrated digital outputs	-	-	-	
Analog inputs	4096	4096	4096	
Analog outputs	4096	4096	4096	
Analog inputs, central	256	256	256	
Analog outputs, central	256	256	256	
Integrated analog inputs	-	-	-	
Integrated analog outputs	-	-	-	
Communication functions				
PG/OP channel	✓	✓	✓	
Global data communication	✓	✓	✓	
Number of GD circuits, max.	8	8	8	
Size of GD packets, max.	54 Byte	54 Byte	54 Byte	
S7 basic communication	✓	✓	✓	
S7 basic communication, user data per job	76 Byte	76 Byte	76 Byte	
S7 communication	✓	✓	✓	
S7 communication as server	✓	✓	✓	
S7 communication as client	-	-	-	
S7 communication, user data per job	160 Byte	160 Byte	160 Byte	
Number of connections, max.	32	32	32	
Functionality Sub-D interfaces				
Type	X2	X2	X2	
Type of interface	RS485	RS485	RS485	
Connector	Sub-D, 9-pin, female	Sub-D, 9-pin, female	Sub-D, 9-pin, female	
Electrically isolated	✓	✓	✓	
MPI	✓	✓	✓	
MP ² (MPI/RS232)	-	-	-	
DP master	-	-	-	
DP slave	-	-	-	
Point-to-point interface	-	-	-	

SLIO
100V
200V
300S
500S
HMI
Teleservice
StarterKits
Safety
Solutions
Software
Accessories
Appendix

CPUs CPU STEP7 programmable, standard					
314-2AG12	315-2AG13				
314-2AG13	317-2AJ12				
314-2BG03	317-2AJ13				
315-2AG12					

Order number	315-2AG13	317-2AJ12	317-2AJ13	
Type	X3	X3	X3	
Type of interface	RS485	RS485	RS485	
Connector	Sub-D, 9-pin, female	Sub-D, 9-pin, female	Sub-D, 9-pin, female	
Electrically isolated	✓	✓	✓	
MPI	-	-	-	
MP ² I (MPI/RS232)	-	-	-	
DP master	yes	yes	yes	
DP slave	yes	yes	yes	
Point-to-point interface	✓	✓	✓	
Functionality MPI				
Number of connections, max.	32	32	32	
PG/OP channel	✓	✓	✓	
Routing	✓	✓	✓	
Global data communication	✓	✓	✓	
S7 basic communication	✓	✓	✓	
S7 communication	✓	✓	✓	
S7 communication as server	✓	✓	✓	
S7 communication as client	-	-	-	
Transmission speed, min.	19.2 kbit/s	19.2 kbit/s	19.2 kbit/s	
Transmission speed, max.	12 Mbit/s	12 Mbit/s	12 Mbit/s	
Functionality PROFIBUS master				
PG/OP channel	✓	✓	✓	
Routing	✓	✓	✓	
S7 basic communication	✓	✓	✓	
S7 communication	✓	✓	✓	
S7 communication as server	✓	✓	✓	
S7 communication as client	-	-	-	
Activation/deactivation of DP slaves	✓	✓	✓	
Direct data exchange (slave-to-slave communication)	-	-	-	
DPV1	✓	✓	✓	
Transmission speed, min.	9.6 kbit/s	9.6 kbit/s	9.6 kbit/s	
Transmission speed, max.	12 Mbit/s	12 Mbit/s	12 Mbit/s	
Number of DP slaves, max.	124	124	124	
Address range inputs, max.	8 KB	8 KB	8 KB	
Address range outputs, max.	8 KB	8 KB	8 KB	
User data inputs per slave, max.	244 Byte	244 Byte	244 Byte	
User data outputs per slave, max.	244 Byte	244 Byte	244 Byte	
Functionality PROFIBUS slave				
PG/OP channel	✓	✓	✓	
Routing	✓	✓	✓	
S7 communication	✓	✓	✓	
S7 communication as server	✓	✓	✓	
S7 communication as client	-	-	-	
Direct data exchange (slave-to-slave communication)	-	-	-	

CPUs CPUs STEP7 programmable, standard					
314-2AG12	315-2AG13				
314-2AG13	317-2AJ12				
314-2BG03	317-2AJ13				
315-2AG12					

Order number	315-2AG13	317-2AJ12	317-2AJ13	
DPV1	✓	✓	✓	
Transmission speed, min.	9.6 kbit/s	9.6 kbit/s	9.6 kbit/s	
Transmission speed, max.	12 Mbit/s	12 Mbit/s	12 Mbit/s	
Automatic detection of transmission speed	-	-	-	
Transfer memory inputs, max.	244 Byte	244 Byte	244 Byte	
Transfer memory outputs, max.	244 Byte	244 Byte	244 Byte	
Address areas, max.	32	32	32	
User data per address area, max.	32 Byte	32 Byte	32 Byte	
Point-to-point communication				
PtP communication	✓	✓	✓	
Interface isolated	✓	✓	✓	
RS232 interface	-	-	-	
RS422 interface	-	-	-	
RS485 interface	✓	✓	✓	
Connector	Sub-D, 9-pin, female	Sub-D, 9-pin, female	Sub-D, 9-pin, female	
Transmission speed, min.	150 bit/s	150 bit/s	150 bit/s	
Transmission speed, max.	115.5 kbit/s	115.5 kbit/s	115.5 kbit/s	
Cable length, max.	500 m	500 m	500 m	
Point-to-point protocol				
ASCII protocol	✓	✓	✓	
STX/ETX protocol	✓	✓	✓	
3964(R) protocol	✓	✓	✓	
RK512 protocol	-	-	-	
USS master protocol	✓	✓	✓	
Modbus master protocol	✓	✓	✓	
Modbus slave protocol	-	-	-	
Special protocols	-	-	-	
Functionality RJ45 interfaces				
Type	X4	X5	X5	
Type of interface	Ethernet 10/100 MBit	Ethernet 10/100 MBit	Ethernet 10/100 MBit	
Connector	RJ45	RJ45	RJ45	
Electrically isolated	✓	✓	✓	
PG/OP channel	✓	✓	✓	
Number of connections, max.	4	4	4	
Productive connections	-	-	-	
Housing				
Material	PPE	PPE	PPE	
Mounting	Rail System 300	Rail System 300	Rail System 300	
Mechanical data				
Dimensions (WxHxD)	40 mm x 125 mm x 120 mm	80 mm x 125 mm x 120 mm	80 mm x 125 mm x 120 mm	
Weight	290 g	420 g	420 g	
Environmental conditions				
Operating temperature	0 °C to 60 °C	0 °C to 60 °C	0 °C to 60 °C	
Storage temperature	-25 °C to 70 °C	-25 °C to 70 °C	-25 °C to 70 °C	
Certifications				
UL508 certification	yes	yes	yes	

SLIO
100V
200V
300S
500S
HMI
Teleservice
StarterKits
Safety
Solutions
Software
Accessories
Appendix

Connections, Interfaces

CPU | CPUs STEP7 programmable, standard

314-2AG12
314-2AG13
314-2BG03
315-2AG12

315-2AG13
317-2AJ12
317-2AJ13

315-2AG13



- + ① + DC 24 V
- ② 0 V



- ① Transmit +
- ② Transmit -
- ③ Receive +
- ④ -
- ⑤ -
- ⑥ Receive -
- ⑦ -
- ⑧ -

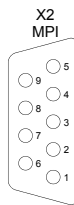

- ① n. c.
- ② M24V
- ③ RxD/TxD-P (line B)
- ④ RTS
- ⑤ M5V
- ⑥ P5V
- ⑦ P24V
- ⑧ RxD/TxD-N (line A)
- ⑨ n.c.

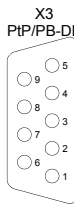

- ① Shield
- ② M24V
- ③ RxD/TxD-P (line B)
- ④ RTS
- ⑤ M5V
- ⑥ P5V
- ⑦ P24V
- ⑧ RxD/TxD-N (line A)
- ⑨ n.c.

317-2AJ12



- + ① + DC 24 V
- ② 0 V



- ① Transmit +
- ② Transmit -
- ③ Receive +
- ④ -
- ⑤ -
- ⑥ Receive -
- ⑦ -
- ⑧ -

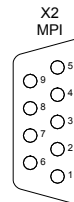

- ① n. c.
- ② M24V
- ③ RxD/TxD-P (line B)
- ④ RTS
- ⑤ M5V
- ⑥ P5V
- ⑦ P24V
- ⑧ RxD/TxD-N (line A)
- ⑨ n.c.

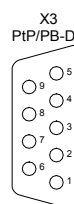

- ① Shield
- ② M24V
- ③ RxD/TxD-P (line B)
- ④ RTS
- ⑤ M5V
- ⑥ P5V
- ⑦ P24V
- ⑧ RxD/TxD-N (line A)
- ⑨ n.c.

SLIO
100V
200V
300S
500S
HMI
Teleservice
StarterKits
Safety
Solutions
Software
Accessories
Appendix

CPUs | CPUs STEP7 programmable, standard



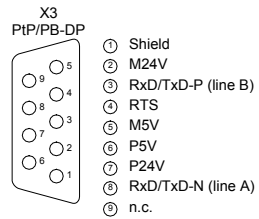
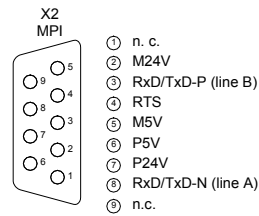
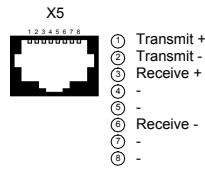
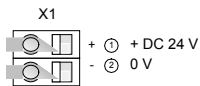

314-2AG12	315-2AG13				
314-2AG13	317-2AJ12				
314-2BG03	317-2AJ13				
315-2AG12					

317-2AJ13



CPUs STEP7 programmable, NET-CPUs

CPUs CPUs STEP7 programmable, NET-CPUs					
315-4NE12					
315-4NE13					
317-4NE12					
317-4NE13					

Order number	315-4NE12	315-4NE13	317-4NE12	317-4NE13
Figure				
Type	CPU 315SN/NET	CPU 315SN/NET	CPU 317SN/NET	CPU 317SN/NET
General information				
Note	-	-	-	-
Features	<ul style="list-style-type: none"> ‣ SPEED7 technology ‣ 1 MB work memory ‣ Memory extension (max. 2 MB) ‣ PROFIBUS-DP master / PtP (switchable) ‣ CP 343 integrated 	<ul style="list-style-type: none"> ‣ SPEED7 technology ‣ 1 MB work memory ‣ Memory extension (max. 2 MB) ‣ PROFIBUS-DP master / PtP (switchable) ‣ CP 343 integrated ‣ Also configurable via TIA-Portal 	<ul style="list-style-type: none"> ‣ SPEED7 technology, SPEED-Bus ‣ 2 MB work memory ‣ Memory extension (max. 8 MB) ‣ PROFIBUS-DP master / PtP (switchable) ‣ CP 343 integrated 	<ul style="list-style-type: none"> ‣ SPEED7 technology, SPEED-Bus ‣ 2 MB work memory ‣ Memory extension (max. 8 MB) ‣ PROFIBUS-DP master / PtP (switchable) ‣ CP 343 integrated ‣ Also configurable via TIA-Portal
SPEED-Bus	-	-	✓	✓
Technical data power supply				
Power supply (rated value)	DC 24 V	DC 24 V	DC 24 V	DC 24 V
Power supply (permitted range)	DC 20.4...28.8 V	DC 20.4...28.8 V	DC 20.4...28.8 V	DC 20.4...28.8 V
Reverse polarity protection	✓	✓	✓	✓
Current consumption (no-load operation)	270 mA	270 mA	270 mA	270 mA
Current consumption (rated value)	1 A	1 A	1.5 A	1.5 A
Inrush current	5 A	5 A	5 A	5 A
I ² t	0.5 A ² s	0.5 A ² s	0.5 A ² s	0.5 A ² s
Max. current drain at backplane bus	2.5 A	2.5 A	4 A	4 A
Power loss	8.5 W	8.5 W	10 W	10 W
Load and working memory				
Load memory, integrated	2 MB	2 MB	8 MB	8 MB
Load memory, maximum	2 MB	2 MB	8 MB	8 MB
Work memory, integrated	1 MB	1 MB	2 MB	2 MB
Work memory, maximal	2 MB	2 MB	8 MB	8 MB
Memory divided in 50% program / 50% data	✓	✓	✓	✓
Memory card slot	MMC-Card with max. 1 GB	MMC-Card with max. 1 GB	MMC-Card with max. 1 GB	MMC-Card with max. 1 GB
Hardware configuration				
Racks, max.	4	4	4	4
Modules per rack, max.	8 in multiple-, 32 in a single-rack configuration	8 in multiple-, 32 in a single-rack configuration	8 in multiple-, 32 in a single-rack configuration	8 in multiple-, 32 in a single-rack configuration
Number of integrated DP master	1	1	1	1
Number of DP master via CP	4	4	4	4
Operable function modules	8	8	8	8
Operable communication modules PtP	8	8	16	16
Operable communication modules LAN	8	8	8	8

SLIO
100V
200V
300S
500S
HMI
Teleservice
StarterKits
Safety
Solutions
Software
Accessories
Appendix

CPU CPU STEP7 programmable, NET-CPU						
315-4NE12						
315-4NE13						
317-4NE12						
317-4NE13						

Order number	315-4NE12	315-4NE13	317-4NE12	317-4NE13
Command processing times				
Bit instructions, min.	0.01 µs	0.01 µs	0.01 µs	0.01 µs
Word instruction, min.	0.01 µs	0.01 µs	0.01 µs	0.01 µs
Double integer arithmetic, min.	0.01 µs	0.01 µs	0.01 µs	0.01 µs
Floating-point arithmetic, min.	0.06 µs	0.06 µs	0.06 µs	0.06 µs
Timers/Counters and their retentive characteristics				
Number of S7 counters	512	512	2048	2048
S7 counter remanence	adjustable 0 up to 512	adjustable 0 up to 512	adjustable 0 up to 2048	adjustable 0 up to 2048
S7 counter remanence adjustable	C0 .. C7	C0 .. C7	C0 .. C7	C0 .. C7
Number of S7 times	512	512	2048	2048
S7 times remanence	adjustable 0 up to 512	adjustable 0 up to 512	adjustable 0 up to 2048	adjustable 0 up to 2048
S7 times remanence adjustable	not retentive	not retentive	not retentive	not retentive
Data range and retentive characteristic				
Number of flags	8192 Byte	8192 Byte	16384 Byte	16384 Byte
Bit memories retentive characteristic adjustable	adjustable 0 up to 8192	adjustable 0 up to 8192	adjustable 0 up to 16384	adjustable 0 up to 16384
Bit memories retentive characteristic preset	MB0 .. MB15	MB0 .. MB15	MB0 .. MB15	MB0 .. MB15
Number of data blocks	4095	4095	8190	8190
Max. data blocks size	64 KB	64 KB	64 KB	64 KB
Number range DBs	1 ... 4095	1 ... 4095	1 ... 8190	1 ... 8190
Max. local data size per execution level	510 Byte	1024 Byte	510 Byte	1024 Byte
Max. local data size per block	510 Byte	1024 Byte	510 Byte	1024 Byte
Blocks				
Number of OBs	24	23	24	23
Maximum OB size	64 KB	64 KB	64 KB	64 KB
Total number DBs, FBs, FCs	-	-	-	-
Number of FBs	2048	2048	8191	8191
Maximum FB size	64 KB	64 KB	64 KB	64 KB
Number range FBs	0 ... 2047	0 ... 2047	0 ... 8190	0 ... 8190
Number of FCs	2048	2048	8191	8191
Maximum FC size	64 KB	64 KB	64 KB	64 KB
Number range FC2	0 ... 2047	0 ... 2047	0 ... 8190	0 ... 8190
Maximum nesting depth per priority class	8	8	16	16
Maximum nesting depth additional within an error OB	4	4	4	4
Time				
Real-time clock buffered	✓	✓	✓	✓
Clock buffered period (min.)	6 w	6 w	6 w	6 w
Type of buffering	-	-	-	-
Load time for 50% buffering period	20 h	20 h	20 h	20 h
Load time for 100% buffering period	48 h	48 h	48 h	48 h
Accuracy (max. deviation per day)	10 s	10 s	10 s	10 s
Number of operating hours counter	8	8	8	8
Clock synchronization	✓	✓	✓	✓
Synchronization via MPI	Master/Slave	Master/Slave	Master/Slave	Master/Slave
Synchronization via Ethernet (NTP)	Slave	Slave	Slave	Slave

CPUs CPUs STEP7 programmable, NET-CPUs					
315-4NE12					
315-4NE13					
317-4NE12					
317-4NE13					

Order number	315-4NE12	315-4NE13	317-4NE12	317-4NE13
Address areas (I/O)				
Input I/O address area	8192 Byte	8192 Byte	8192 Byte	8192 Byte
Output I/O address area	8192 Byte	8192 Byte	8192 Byte	8192 Byte
Process image adjustable	✓	✓	✓	✓
Input process image preset	256 Byte	256 Byte	256 Byte	256 Byte
Output process image preset	256 Byte	256 Byte	256 Byte	256 Byte
Input process image maximal	2048 Byte	2048 Byte	8192 Byte	8192 Byte
Output process image maximal	2048 Byte	2048 Byte	8192 Byte	8192 Byte
Digital inputs	65536	65536	65536	65536
Digital outputs	65536	65536	65536	65536
Digital inputs central	1024	1024	1024	1024
Digital outputs central	1024	1024	1024	1024
Integrated digital inputs	-	-	-	-
Integrated digital outputs	-	-	-	-
Analog inputs	4096	4096	4096	4096
Analog outputs	4096	4096	4096	4096
Analog inputs, central	256	256	256	256
Analog outputs, central	256	256	256	256
Integrated analog inputs	-	-	-	-
Integrated analog outputs	-	-	-	-
Communication functions				
PG/OP channel	✓	✓	✓	✓
Global data communication	✓	✓	✓	✓
Number of GD circuits, max.	8	8	8	8
Size of GD packets, max.	54 Byte	54 Byte	54 Byte	54 Byte
S7 basic communication	✓	✓	✓	✓
S7 basic communication, user data per job	76 Byte	76 Byte	76 Byte	76 Byte
S7 communication	✓	✓	✓	✓
S7 communication as server	✓	✓	✓	✓
S7 communication as client	-	-	-	-
S7 communication, user data per job	160 Byte	160 Byte	160 Byte	160 Byte
Number of connections, max.	32	32	32	32
Functionality Sub-D interfaces				
Type	X2	X2	X2	X2
Type of interface	RS485	RS485	RS485	RS485
Connector	Sub-D, 9-pin, female	Sub-D, 9-pin, female	Sub-D, 9-pin, female	Sub-D, 9-pin, female
Electrically isolated	✓	✓	✓	✓
MPI	✓	✓	✓	✓
MP ² I (MPI/RS232)	-	-	-	-
DP master	-	-	-	-
DP slave	-	-	-	-
Point-to-point interface	-	-	-	-
Functionality RS485 interfaces				
Type	X3	X3	X3	X3
Type of interface	RS485	RS485	RS485	RS485

SLIO
100V
200V
300S
500S
HMI
Teleservice
StarterKits
Safety
Solutions
Software
Accessories
Appendix
434

CPU CPU STEP7 programmable, NET-CPU					
315-4NE12					
315-4NE13					
317-4NE12					
317-4NE13					

Order number	315-4NE12	315-4NE13	317-4NE12	317-4NE13
Connector	Sub-D, 9-pin, female	Sub-D, 9-pin, female	Sub-D, 9-pin, female	Sub-D, 9-pin, female
Electrically isolated	✓	✓	✓	✓
MPI	-	-	-	-
MP ² (MPI/RS232)	-	-	-	-
DP master	yes	yes	yes	yes
DP slave	yes	yes	yes	yes
Point-to-point interface	✓	✓	✓	✓
Functionality MPI				
Number of connections, max.	32	32	32	32
PG/OP channel	✓	✓	✓	✓
Routing	✓	✓	✓	✓
Global data communication	✓	✓	✓	✓
S7 basic communication	✓	✓	✓	✓
S7 communication	✓	✓	✓	✓
S7 communication as server	✓	✓	✓	✓
S7 communication as client	-	-	-	-
Transmission speed, min.	19.2 kbit/s	19.2 kbit/s	19.2 kbit/s	19.2 kbit/s
Transmission speed, max.	12 Mbit/s	12 Mbit/s	12 Mbit/s	12 Mbit/s
Functionality PROFIBUS master				
PG/OP channel	✓	✓	✓	✓
Routing	✓	✓	✓	✓
S7 basic communication	✓	✓	✓	✓
S7 communication	✓	✓	✓	✓
S7 communication as server	✓	✓	✓	✓
S7 communication as client	-	-	-	-
Activation/deactivation of DP slaves	✓	✓	✓	✓
Direct data exchange (slave-to-slave communication)	-	-	-	-
DPV1	✓	✓	✓	✓
Transmission speed, min.	9.6 kbit/s	9.6 kbit/s	9.6 kbit/s	9.6 kbit/s
Transmission speed, max.	12 Mbit/s	12 Mbit/s	12 Mbit/s	12 Mbit/s
Number of DP slaves, max.	124	124	124	124
Address range inputs, max.	8 KB	8 KB	8 KB	8 KB
Address range outputs, max.	8 KB	8 KB	8 KB	8 KB
User data inputs per slave, max.	244 Byte	244 Byte	244 Byte	244 Byte
User data outputs per slave, max.	244 Byte	244 Byte	244 Byte	244 Byte
Functionality PROFIBUS slave				
PG/OP channel	✓	✓	✓	✓
Routing	✓	✓	✓	✓
S7 communication	✓	✓	✓	✓
S7 communication as server	✓	✓	✓	✓
S7 communication as client	-	-	-	-
Direct data exchange (slave-to-slave communication)	-	-	-	-
DPV1	✓	✓	✓	✓
Transmission speed, min.	9.6 kbit/s	9.6 kbit/s	9.6 kbit/s	9.6 kbit/s

SLIO
100V
200V
300S
500S
HMI
Teleservice
StarterKits
Safety
Solutions
Software
Accessories
Appendix

CPU CPUs STEP7 programmable, NET-CPU					
315-4NE12					
315-4NE13					
317-4NE12					
317-4NE13					

Order number	315-4NE12	315-4NE13	317-4NE12	317-4NE13
Transmission speed, max.	12 Mbit/s	12 Mbit/s	12 Mbit/s	12 Mbit/s
Automatic detection of transmission speed	-	-	-	-
Transfer memory inputs, max.	244 Byte	244 Byte	244 Byte	244 Byte
Transfer memory outputs, max.	244 Byte	244 Byte	244 Byte	244 Byte
Address areas, max.	32	32	32	32
User data per address area, max.	32 Byte	32 Byte	32 Byte	32 Byte
Point-to-point communication				
PtP communication	✓	✓	✓	✓
Interface isolated	✓	✓	✓	✓
RS232 interface	-	-	-	-
RS422 interface	-	-	-	-
RS485 interface	✓	✓	✓	✓
Connector	Sub-D, 9-pin, female	Sub-D, 9-pin, female	Sub-D, 9-pin, female	Sub-D, 9-pin, female
Transmission speed, min.	150 bit/s	150 bit/s	150 bit/s	150 bit/s
Transmission speed, max.	115.5 kbit/s	115.5 kbit/s	115.5 kbit/s	115.5 kbit/s
Cable length, max.	500 m	500 m	500 m	500 m
Point-to-point protocol				
ASCII protocol	✓	✓	✓	✓
STX/ETX protocol	✓	✓	✓	✓
3964(R) protocol	✓	✓	✓	✓
RK512 protocol	-	-	-	-
USS master protocol	✓	✓	✓	✓
Modbus master protocol	✓	✓	✓	✓
Modbus slave protocol	-	-	-	-
Special protocols	-	-	-	-
Functionality RJ45 interfaces				
Type	X5	X5	X5	X5
Type of interface	Ethernet 10/100 MBit	Ethernet 10/100 MBit	Ethernet 10/100 MBit	Ethernet 10/100 MBit
Connector	RJ45	RJ45	RJ45	RJ45
Electrically isolated	✓	✓	✓	✓
PG/OP channel	✓	✓	✓	✓
Number of connections, max.	4	4	4	4
Productive connections	-	-	-	-
Type	X8	X8	X8	X8
Type of interface	Ethernet 10/100 MBit	Ethernet 10/100 MBit	Ethernet 10/100 MBit	Ethernet 10/100 MBit
Connector	RJ45	RJ45	RJ45	RJ45
Electrically isolated	✓	✓	✓	✓
PG/OP channel	✓	✓	✓	✓
Number of connections, max.	32	32	32	32
Productive connections	✓	✓	✓	✓
Ethernet communication CP				
Number of productive connections, max.	8	8	64	64
Number of productive connections by Siemens NetPro, max.	8	8	16	16

CPU CPU STEP7 programmable, NET-CPU					
315-4NE12					
315-4NE13					
317-4NE12					
317-4NE13					

Order number	315-4NE12	315-4NE13	317-4NE12	317-4NE13
S7 connections	BSEND, BRCV, GET, PUT, Connection of active and passive data handling	BSEND, BRCV, GET, PUT, Connection of active and passive data handling	BSEND, BRCV, GET, PUT, Connection of active and passive data handling	BSEND, BRCV, GET, PUT, Connection of active and passive data handling
User data per S7 connection, max.	32 KB	32 KB	32 KB	32 KB
TCP-connections	SEND, RECEIVE, FETCH PASSIV, WRITE PASSIV, Connection of active and passive data handling	SEND, RECEIVE, FETCH PASSIV, WRITE PASSIV, Connection of active and passive data handling	SEND, RECEIVE, FETCH PASSIV, WRITE PASSIV, Connection of active and passive data handling	SEND, RECEIVE, FETCH PASSIV, WRITE PASSIV, Connection of active and passive data handling
User data per TCP connection, max.	64 KB	64 KB	64 KB	64 KB
ISO-connections	SEND, RECEIVE, FETCH PASSIV, WRITE PASSIV, Connection of active and passive data handling	SEND, RECEIVE, FETCH PASSIV, WRITE PASSIV, Connection of active and passive data handling	SEND, RECEIVE, FETCH PASSIV, WRITE PASSIV, Connection of active and passive data handling	SEND, RECEIVE, FETCH PASSIV, WRITE PASSIV, Connection of active and passive data handling
User data per ISO connection, max.	8 KB	8 KB	8 KB	8 KB
ISO on TCP connections (RFC 1006)	SEND, RECEIVE, FETCH PASSIV, WRITE PASSIV, Connection of active and passive data handling	SEND, RECEIVE, FETCH PASSIV, WRITE PASSIV, Connection of active and passive data handling	SEND, RECEIVE, FETCH PASSIV, WRITE PASSIV, Connection of active and passive data handling	SEND, RECEIVE, FETCH PASSIV, WRITE PASSIV, Connection of active and passive data handling
User data per ISO on TCP connection, max.	32 KB	32 KB	32 KB	32 KB
UDP-connections	SEND and RECEIVE	SEND and RECEIVE	SEND and RECEIVE	SEND and RECEIVE
User data per UDP connection, max.	2 KB	2 KB	2 KB	2 KB
UDP-multicast-connections	SEND and RECEIVE (max. 8 Multicast groups)	SEND and RECEIVE (max. 8 Multicast groups)	SEND and RECEIVE (max. 16 Multicast groups)	SEND and RECEIVE (max. 16 Multicast groups)
UDP-broadcast-connections	SEND	SEND	SEND	SEND
Ethernet open communication				
Number of connections, max.	8	8	8	8
User data per ISO on TCP connection, max.	8 KB	8 KB	8 KB	8 KB
User data per native TCP connection, max.	8 KB	8 KB	8 KB	8 KB
User data per ad hoc TCP connection, max.	1460 Byte	1460 Byte	1460 Byte	1460 Byte
User data per UDP connection, max.	1472 Byte	1472 Byte	1472 Byte	1472 Byte
Housing				
Material	PPE	PPE	PPE	PPE
Mounting	Rail System 300	Rail System 300	Rail System 300	Rail System 300
Mechanical data				
Dimensions (WxHxD)	80 mm x 125 mm x 120 mm	80 mm x 125 mm x 120 mm	80 mm x 125 mm x 120 mm	80 mm x 125 mm x 120 mm
Weight	430 g	430 g	440 g	440 g
Environmental conditions				
Operating temperature	0 °C to 60 °C	0 °C to 60 °C	0 °C to 60 °C	0 °C to 60 °C
Storage temperature	-25 °C to 70 °C	-25 °C to 70 °C	-25 °C to 70 °C	-25 °C to 70 °C
Certifications				
UL508 certification	yes	yes	yes	yes

SLIO
100V
200V
300S
500S
HMI
Teleservice
StarterKits
Safety
Solutions
Software
Accessories
Appendix

Connections, Interfaces

CPU | CPUs STEP7 programmable, NET-CPU

315-4NE12
315-4NE13
317-4NE12
317-4NE13

315-4NE12



- + ① + DC 24 V
- ② 0 V



- ① Transmit +
- ② Transmit -
- ③ Receive +
- ④ -
- ⑤ -
- ⑥ Receive -
- ⑦ -
- ⑧ -

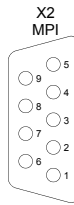

- ① n. c.
- ② M24V
- ③ RxD/TxD-P (line B)
- ④ RTS
- ⑤ M5V
- ⑥ P5V
- ⑦ P24V
- ⑧ RxD/TxD-N (line A)
- ⑨ n.c.

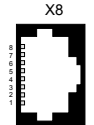

- ① Transmit +
- ② Transmit -
- ③ Receive +
- ④ -
- ⑤ -
- ⑥ Receive -
- ⑦ -
- ⑧ -

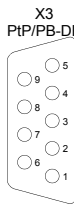

- ① Shield
- ② M24V
- ③ RxD/TxD-P (line B)
- ④ RTS
- ⑤ M5V
- ⑥ P5V
- ⑦ P24V
- ⑧ RxD/TxD-N (line A)
- ⑨ n.c.

315-4NE13



- + ① + DC 24 V
- ② 0 V



- ① Transmit +
- ② Transmit -
- ③ Receive +
- ④ -
- ⑤ -
- ⑥ Receive -
- ⑦ -
- ⑧ -

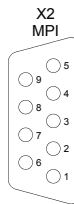

- ① n. c.
- ② M24V
- ③ RxD/TxD-P (line B)
- ④ RTS
- ⑤ M5V
- ⑥ P5V
- ⑦ P24V
- ⑧ RxD/TxD-N (line A)
- ⑨ n.c.

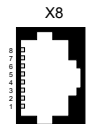

- ① Transmit +
- ② Transmit -
- ③ Receive +
- ④ -
- ⑤ -
- ⑥ Receive -
- ⑦ -
- ⑧ -

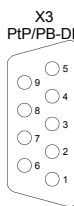

- ① Shield
- ② M24V
- ③ RxD/TxD-P (line B)
- ④ RTS
- ⑤ M5V
- ⑥ P5V
- ⑦ P24V
- ⑧ RxD/TxD-N (line A)
- ⑨ n.c.

CPU | CPU STEP7 programmable, NET-CPU

315-4NE12
 315-4NE13
 317-4NE12
 317-4NE13

317-4NE12



+ ① + DC 24 V
 - ② 0 V

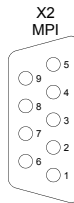

① n. c.
 ② M24V
 ③ RxD/TxD-P (line B)
 ④ RTS
 ⑤ M5V
 ⑥ P5V
 ⑦ P24V
 ⑧ RxD/TxD-N (line A)
 ⑨ n.c.

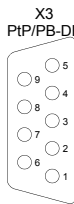

① Shield
 ② M24V
 ③ RxD/TxD-P (line B)
 ④ RTS
 ⑤ M5V
 ⑥ P5V
 ⑦ P24V
 ⑧ RxD/TxD-N (line A)
 ⑨ n.c.



① Transmit +
 ② Transmit -
 ③ Receive +
 ④ -
 ⑤ -
 ⑥ Receive -
 ⑦ -
 ⑧ -

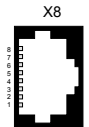

① Transmit +
 ② Transmit -
 ③ Receive +
 ④ -
 ⑤ -
 ⑥ Receive -
 ⑦ -
 ⑧ -

317-4NE13



+ ① + DC 24 V
 - ② 0 V

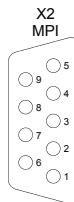

① n. c.
 ② M24V
 ③ RxD/TxD-P (line B)
 ④ RTS
 ⑤ M5V
 ⑥ P5V
 ⑦ P24V
 ⑧ RxD/TxD-N (line A)
 ⑨ n.c.

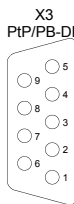

① Shield
 ② M24V
 ③ RxD/TxD-P (line B)
 ④ RTS
 ⑤ M5V
 ⑥ P5V
 ⑦ P24V
 ⑧ RxD/TxD-N (line A)
 ⑨ n.c.



① Transmit +
 ② Transmit -
 ③ Receive +
 ④ -
 ⑤ -
 ⑥ Receive -
 ⑦ -
 ⑧ -





① Transmit +
 ② Transmit -
 ③ Receive +
 ④ -
 ⑤ -
 ⑥ Receive -
 ⑦ -
 ⑧ -

SLIO
 100V
 200V
 300S
 500S
 HMI
 Teleservice
 StarterKits
 Safety
 Solutions
 Software
 Accessories
 Appendix

CPU | CPUs STEP7 programmable, PROFINET

CPU CPUs STEP7 programmable, PROFINET					
315-4PN12					
315-4PN33					
317-4PN12					

Order number	315-4PN12	315-4PN33	317-4PN12	
Figure				
Type	CPU 315SN/PN	CPU 315SN/PN ECO	CPU 317SN/PN	
General information				
Note	-	-	-	
Features	<ul style="list-style-type: none"> ▶ SPEED7 technology ▶ 1 MB work memory ▶ Memory extension (max. 2 MB) ▶ PROFIBUS-DP master / PtP (switchable) ▶ PROFINET controller integrated ▶ Also configurable via TIA-Portal 	<ul style="list-style-type: none"> ▶ SPEED7 technology ▶ 512 KB work memory ▶ PtP ▶ PROFINET controller integrated ▶ Also configurable via TIA-Portal 	<ul style="list-style-type: none"> ▶ SPEED7 technology, SPEED-Bus ▶ 2 MB work memory ▶ Memory extension (max. 8 MB) ▶ PROFIBUS-DP master / PtP (switchable) ▶ PROFINET Controller integrated ▶ Also configurable via TIA-Portal 	
SPEED-Bus	-	-	✓	
Technical data power supply				
Power supply (rated value)	DC 24 V	DC 24 V	DC 24 V	
Power supply (permitted range)	DC 20.4...28.8 V	DC 20.4...28.8 V	DC 20.4...28.8 V	
Reverse polarity protection	✓	✓	✓	
Current consumption (no-load operation)	270 mA	200 mA	270 mA	
Current consumption (rated value)	1.1 A	0.7 A	1.5 A	
Inrush current	6 A	11 A	6 A	
I²t	0.28 A²s	0.4 A²s	0.28 A²s	
Max. current drain at backplane bus	2.5 A	2 A	3 A	
Power loss	8.5 W	5.5 W	10 W	
Load and working memory				
Load memory, integrated	2 MB	512 KB	8 MB	
Load memory, maximum	2 MB	512 KB	8 MB	
Work memory, integrated	1 MB	512 KB	2 MB	
Work memory, maximal	2 MB	512 KB	8 MB	
Memory divided in 50% program / 50% data	✓	✓	✓	
Memory card slot	MMC-Card with max. 1 GB	MMC-Card with max. 1 GB	MMC-Card with max. 1 GB	
Hardware configuration				
Racks, max.	4	4	4	
Modules per rack, max.	8 in multiple-, 32 in a single-rack configuration	8 in multiple-, 32 in a single-rack configuration	8 in multiple-, 32 in a single-rack configuration	
Number of integrated DP master	1	0	1	
Number of DP master via CP	4	4	4	
Operable function modules	8	8	8	
Operable communication modules PtP	8	8	16	
Operable communication modules LAN	8	8	8	

CPUs CPU STEP7 programmable, PROFINET						
315-4PN12						
315-4PN33						
317-4PN12						

Order number	315-4PN12	315-4PN33	317-4PN12	
Command processing times				
Bit instructions, min.	0.01 µs	0.01 µs	0.01 µs	
Word instruction, min.	0.01 µs	0.01 µs	0.01 µs	
Double integer arithmetic, min.	0.01 µs	0.01 µs	0.01 µs	
Floating-point arithmetic, min.	0.06 µs	0.06 µs	0.06 µs	
Timers/Counters and their retentive characteristics				
Number of S7 counters	512	512	2048	
S7 counter remanence	adjustable 0 up to 512	adjustable 0 up to 512	adjustable 0 up to 2048	
S7 counter remanence adjustable	C0 .. C7	C0 .. C7	C0 .. C7	
Number of S7 times	512	512	2048	
S7 times remanence	adjustable 0 up to 512	adjustable 0 up to 512	adjustable 0 up to 2048	
S7 times remanence adjustable	not retentive	not retentive	not retentive	
Data range and retentive characteristic				
Number of flags	8192 Byte	8192 Byte	16384 Byte	
Bit memories retentive characteristic adjustable	adjustable 0 up to 8192	adjustable 0 up to 8192	adjustable 0 up to 16384	
Bit memories retentive characteristic preset	MB0 .. MB15	MB0 .. MB15	MB0 .. MB15	
Number of data blocks	4095	4095	8190	
Max. data blocks size	64 KB	64 KB	64 KB	
Number range DBs	1 ... 4095	1 ... 4095	1 ... 8190	
Max. local data size per execution level	1024 Byte	1024 Byte	1024 Byte	
Max. local data size per block	1024 Byte	1024 Byte	1024 Byte	
Blocks				
Number of OBs	24	20	24	
Maximum OB size	64 KB	64 KB	64 KB	
Total number DBs, FBs, FCs	-	-	-	
Number of FBs	2048	2048	8191	
Maximum FB size	64 KB	64 KB	64 KB	
Number range FBs	0 ... 2047	0 ... 2047	0 ... 8190	
Number of FCs	2048	2048	8191	
Maximum FC size	64 KB	64 KB	64 KB	
Number range FC2	0 ... 2047	0 ... 2047	0 ... 8190	
Maximum nesting depth per priority class	8	8	16	
Maximum nesting depth additional within an error OB	4	4	4	
Time				
Real-time clock buffered	✓	✓	✓	
Clock buffered period (min.)	6 w	6 w	6 w	
Type of buffering	-	-	-	
Load time for 50% buffering period	20 h	20 h	20 h	
Load time for 100% buffering period	48 h	48 h	48 h	
Accuracy (max. deviation per day)	10 s	10 s	10 s	
Number of operating hours counter	8	8	8	
Clock synchronization	✓	✓	✓	
Synchronization via MPI	Master/Slave	Master/Slave	Master/Slave	

SLIO
100V
200V
300S
500S
HMI
Teleservice
StarterKits
Safety
Solutions
Software
Accessories
Appendix

CPUs CPUs STEP7 programmable, PROFINET						
315-4PN12						
315-4PN33						
317-4PN12						

Order number	315-4PN12	315-4PN33	317-4PN12	
Synchronization via Ethernet (NTP)	Slave	Slave	Slave	
Address areas (I/O)				
Input I/O address area	2048 Byte	2048 Byte	8192 Byte	
Output I/O address area	2048 Byte	2048 Byte	8192 Byte	
Process image adjustable	✓	✓	✓	
Input process image preset	256 Byte	256 Byte	256 Byte	
Output process image preset	256 Byte	256 Byte	256 Byte	
Input process image maximal	2048 Byte	2048 Byte	8192 Byte	
Output process image maximal	2048 Byte	2048 Byte	8192 Byte	
Digital inputs	16384	16384	65536	
Digital outputs	16384	16384	65536	
Digital inputs central	1024	1024	1024	
Digital outputs central	1024	1024	1024	
Integrated digital inputs	-	-	-	
Integrated digital outputs	-	-	-	
Analog inputs	1024	1024	4096	
Analog outputs	1024	1024	4096	
Analog inputs, central	256	256	256	
Analog outputs, central	256	256	256	
Integrated analog inputs	-	-	-	
Integrated analog outputs	-	-	-	
Communication functions				
PG/OP channel	✓	✓	✓	
Global data communication	✓	✓	✓	
Number of GD circuits, max.	8	8	8	
Size of GD packets, max.	22 Byte	22 Byte	22 Byte	
S7 basic communication	✓	✓	✓	
S7 basic communication, user data per job	76 Byte	76 Byte	76 Byte	
S7 communication	✓	✓	✓	
S7 communication as server	✓	✓	✓	
S7 communication as client	-	-	-	
S7 communication, user data per job	160 Byte	160 Byte	160 Byte	
Number of connections, max.	32	32	32	
Functionality Sub-D interfaces				
Type	X2	X2	X2	
Type of interface	RS485	RS485	RS485	
Connector	Sub-D, 9-pin, female	Sub-D, 9-pin, female	Sub-D, 9-pin, female	
Electrically isolated	✓	✓	✓	
MPI	✓	✓	✓	
MP ² 1 (MPI/RS232)	-	-	-	
DP master	-	-	-	
DP slave	-	-	-	
Point-to-point interface	-	-	-	

SLIO
100V
200V
300S
500S
HMI
Teleservice
StarterKits
Safety
Solutions
Software
Accessories
Appendix

CPUs CPUs STEP7 programmable, PROFINET						
315-4PN12						
315-4PN33						
317-4PN12						

Order number	315-4PN12	315-4PN33	317-4PN12	
Type	X3	X3	X3	
Type of interface	RS485	RS485	RS485	
Connector	Sub-D, 9-pin, female	Sub-D, 9-pin, female	Sub-D, 9-pin, female	
Electrically isolated	✓	✓	✓	
MPI	-	-	-	
MP ² I (MPI/RS232)	-	-	-	
DP master	yes	-	yes	
DP slave	yes	-	yes	
Point-to-point interface	✓	✓	✓	
Functionality MPI				
Number of connections, max.	32	32	32	
PG/OP channel	✓	✓	✓	
Routing	✓	✓	✓	
Global data communication	✓	✓	✓	
S7 basic communication	✓	✓	✓	
S7 communication	✓	✓	✓	
S7 communication as server	✓	✓	✓	
S7 communication as client	-	-	-	
Transmission speed, min.	19.2 kbit/s	19.2 kbit/s	19.2 kbit/s	
Transmission speed, max.	12 Mbit/s	12 Mbit/s	12 Mbit/s	
Functionality PROFIBUS master				
PG/OP channel	✓	-	✓	
Routing	✓	-	✓	
S7 basic communication	✓	-	✓	
S7 communication	✓	-	✓	
S7 communication as server	✓	-	✓	
S7 communication as client	-	-	-	
Activation/deactivation of DP slaves	✓	-	✓	
Direct data exchange (slave-to-slave communication)	-	-	-	
DPV1	✓	-	✓	
Transmission speed, min.	9.6 kbit/s	-	9.6 kbit/s	
Transmission speed, max.	12 Mbit/s	-	12 Mbit/s	
Number of DP slaves, max.	124	-	124	
Address range inputs, max.	8 KB	-	8 KB	
Address range outputs, max.	8 KB	-	8 KB	
User data inputs per slave, max.	244 Byte	-	244 Byte	
User data outputs per slave, max.	244 Byte	-	244 Byte	
Functionality PROFIBUS slave				
PG/OP channel	✓	-	✓	
Routing	✓	-	✓	
S7 communication	✓	-	✓	
S7 communication as server	✓	-	✓	
S7 communication as client	-	-	-	

CPUs CPUs STEP7 programmable, PROFINET						
315-4PN12						
315-4PN33						
317-4PN12						

Order number	315-4PN12	315-4PN33	317-4PN12	
Direct data exchange (slave-to-slave communication)	-	-	-	
DPV1	✓	-	✓	
Transmission speed, min.	9.6 kbit/s	-	9.6 kbit/s	
Transmission speed, max.	12 Mbit/s	-	12 Mbit/s	
Automatic detection of transmission speed	-	-	-	
Transfer memory inputs, max.	244 Byte	-	244 Byte	
Transfer memory outputs, max.	244 Byte	-	244 Byte	
Address areas, max.	32	-	32	
User data per address area, max.	32 Byte	-	32 Byte	
Point-to-point communication				
PtP communication	✓	✓	✓	
Interface isolated	✓	✓	✓	
RS232 interface	-	-	-	
RS422 interface	-	-	-	
RS485 interface	✓	✓	✓	
Connector	Sub-D, 9-pin, female	Sub-D, 9-pin, female	Sub-D, 9-pin, female	
Transmission speed, min.	150 bit/s	150 bit/s	150 bit/s	
Transmission speed, max.	115.5 kbit/s	115.5 kbit/s	115.5 kbit/s	
Cable length, max.	500 m	500 m	500 m	
Point-to-point protocol				
ASCII protocol	✓	✓	✓	
STX/ETX protocol	✓	✓	✓	
3964(R) protocol	✓	✓	✓	
RK512 protocol	-	-	-	
USS master protocol	✓	✓	✓	
Modbus master protocol	✓	✓	✓	
Modbus slave protocol	-	-	-	
Special protocols	-	-	-	
Functionality PROFINET I/O controller				
Realtime Class	-	-	-	
Conformance Class	PROFINET IO	PROFINET IO	PROFINET IO	
Number of PN IO devices	128	128	128	
IRT support	-	-	-	
Prioritized start-up	-	-	-	
Number of PN IO lines	1	1	1	
Address range inputs, max.	2 KB	2 KB	4 KB	
Address range outputs, max.	2 KB	2 KB	4 KB	
Transmitting clock	1 ms	1 ms	1 ms	
Update time	1 ms .. 512 ms	1 ms .. 512 ms	1 ms .. 512 ms	

CPU CPU STEP7 programmable, PROFINET						
315-4PN12						
315-4PN33						
317-4PN12						

Order number	315-4PN12	315-4PN33	317-4PN12	
Functionality RJ45 interfaces				
Type	X5	X5	X5	
Type of interface	Ethernet 10/100 MBit	Ethernet 10/100 MBit	Ethernet 10/100 MBit	
Connector	RJ45	RJ45	RJ45	
Electrically isolated	✓	✓	✓	
PG/OP channel	✓	✓	✓	
Number of connections, max.	4	4	4	
Productive connections	-	-	-	
Functionality X8 interfaces				
Type	X8	X8	X8	
Type of interface	Ethernet 10/100 MBit	Ethernet 10/100 MBit	Ethernet 10/100 MBit	
Connector	RJ45	RJ45	RJ45	
Electrically isolated	✓	✓	✓	
PG/OP channel	✓	✓	✓	
Number of connections, max.	8	8	8	
Productive connections	✓	✓	✓	
Ethernet communication CP				
Number of productive connections, max.	8	8	24	
Number of productive connections by Siemens NetPro, max.	8	8	16	
S7 connections	BSEND, BRCV, GET, PUT, Connection of active and passive data handling	BSEND, BRCV, GET, PUT, Connection of active and passive data handling	BSEND, BRCV, GET, PUT, Connection of active and passive data handling	
User data per S7 connection, max.	32 KB	32 KB	32 KB	
TCP-connections	FETCH PASSIV, WRITE PASSIV, Connection of passive data handling	FETCH PASSIV, WRITE PASSIV, Connection of passive data handling	FETCH PASSIV, WRITE PASSIV, Connection of passive data handling	
User data per TCP connection, max.	64 KB	64 KB	64 KB	
ISO-connections	-	-	-	
User data per ISO connection, max.	-	-	-	
ISO on TCP connections (RFC 1006)	FETCH PASSIV, WRITE PASSIV, Connection of passive data handling	FETCH PASSIV, WRITE PASSIV, Connection of passive data handling	FETCH PASSIV, WRITE PASSIV, Connection of passive data handling	
User data per ISO on TCP connection, max.	32 KB	32 KB	32 KB	
UDP-connections	-	-	-	
User data per UDP connection, max.	-	-	-	
UDP-multicast-connections	-	-	-	
UDP-broadcast-connections	-	-	-	

SLIO
100V
200V
300S
500S
HMI
Teleservice
StarterKits
Safety
Solutions
Software
Accessories
Appendix

CPUs CPUs STEP7 programmable, PROFINET						
315-4PN12						
315-4PN33						
317-4PN12						

Order number	315-4PN12	315-4PN33	317-4PN12	
Ethernet open communication				
Number of connections, max.	8	8	24	
User data per ISO on TCP connection, max.	8 KB	8 KB	8 KB	
User data per native TCP connection, max.	8 KB	8 KB	8 KB	
User data per ad hoc TCP connection, max.	1460 Byte	1460 Byte	1460 Byte	
User data per UDP connection, max.	1472 Byte	1472 Byte	1472 Byte	
Housing				
Material	PPE	PPE	PPE	
Mounting	Rail System 300	Rail System 300	Rail System 300	
Mechanical data				
Dimensions (WxHxD)	80 mm x 125 mm x 120 mm	80 mm x 125 mm x 120 mm	80 mm x 125 mm x 120 mm	
Weight	430 g	380 g	440 g	
Environmental conditions				
Operating temperature	0 °C to 60 °C	0 °C to 60 °C	0 °C to 60 °C	
Storage temperature	-25 °C to 70 °C	-25 °C to 70 °C	-25 °C to 70 °C	
Certifications				
UL508 certification	yes	in preparation	yes	

Connections, Interfaces

CPU STEP7 programmable, PROFINET

315-4PN12
315-4PN33
317-4PN12

315-4PN12



- + ① + DC 24 V
- ② 0 V



- ① Transmit +
- ② Transmit -
- ③ Receive +
- ④ -
- ⑤ -
- ⑥ Receive -
- ⑦ -
- ⑧ -

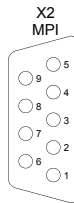

- ① n. c.
- ② M24V
- ③ RxD/TxD-P (line B)
- ④ RTS
- ⑤ M5V
- ⑥ P5V
- ⑦ P24V
- ⑧ RxD/TxD-N (line A)
- ⑨ n.c.

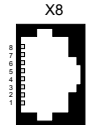

- ① Transmit +
- ② Transmit -
- ③ Receive +
- ④ -
- ⑤ -
- ⑥ Receive -
- ⑦ -
- ⑧ -

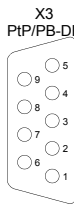

- ① shield
- ② M24V
- ③ RxD/TxD-P (line B)
- ④ RTS
- ⑤ M5V
- ⑥ P5V
- ⑦ P24V
- ⑧ RxD/TxD-N (line A)
- ⑨ n.c.

315-4PN33



- + ① + DC 24 V
- ② 0 V



- ① Transmit +
- ② Transmit -
- ③ Receive +
- ④ -
- ⑤ -
- ⑥ Receive -
- ⑦ -
- ⑧ -

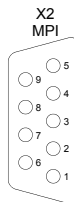

- ① n. c.
- ② M24V
- ③ RxD/TxD-P (line B)
- ④ RTS
- ⑤ M5V
- ⑥ P5V
- ⑦ P24V
- ⑧ RxD/TxD-N (line A)
- ⑨ n.c.

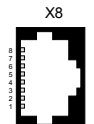

- ① Transmit +
- ② Transmit -
- ③ Receive +
- ④ -
- ⑤ -
- ⑥ Receive -
- ⑦ -
- ⑧ -

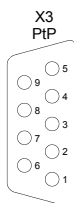

- ① n.c.
- ② M24V
- ③ RxD/TxD-P (line B)
- ④ RTS
- ⑤ M5V
- ⑥ P5V
- ⑦ P24V
- ⑧ RxD/TxD-N (line A)
- ⑨ n.c.

SLIO
100V
200V
300S
500S
HMI
Teleservice
StarterKits
Safety
Solutions
Software
Accessories
Appendix

CPU | CPUs STEP7 programmable, PROFINET

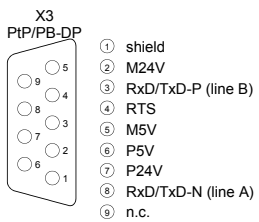
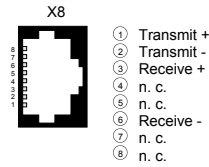
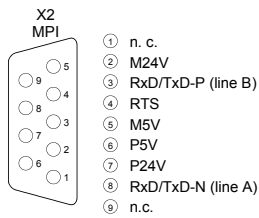
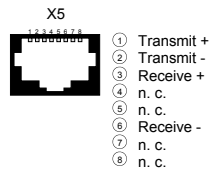
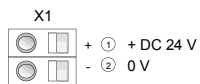

315-4PN12
315-4PN33
317-4PN12

317-4PN12

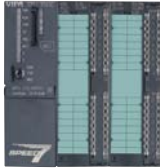

CPUs STEP7 programmable, class C

CPUs CPUs STEP7 programmable, class C					
312-5BE13	314-6CF03				
313-5BF13	314-6CG13				
313-6CF13					
314-6CF02					

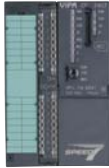
Order number	312-5BE13	313-5BF13	313-6CF13	314-6CF02
Figure				
Type	CPU 312SC	CPU 313SC	CPU 313SC/DPM	CPU 314ST/DPM
General information				
Note	-	-	-	-
Features	<ul style="list-style-type: none"> ▶ SPEED7 technology ▶ 16 x DI, 8 x DO ▶ 64 kB work memory ▶ Memory extension (max. 512 kB) ▶ PtP interface ▶ Also configurable via TIA-Portal 	<ul style="list-style-type: none"> ▶ SPEED7 technology ▶ 24 x DI, 16 x DO, 4 x AI, 2 x AO, 1 x AI Pt100 ▶ 128 kB work memory ▶ Memory extension (max. 512 kB) ▶ PtP interface ▶ Also configurable via TIA-Portal 	<ul style="list-style-type: none"> ▶ SPEED7 technology ▶ 16 x DI, 16 x DO ▶ 128 kB work memory ▶ Memory extension (max. 512 kB) ▶ PROFIBUS-DP master / PtP (switchable) ▶ Also configurable via TIA-Portal 	<ul style="list-style-type: none"> ▶ SPEED7 technology, SPEED-Bus ▶ 8 x DI, 8 x DO, 4 x AI, 2 x AO, 1 x AI Pt100 ▶ 512 kB work memory ▶ Memory extension (max. 2 MB) ▶ PROFIBUS-DP master / PtP (switchable)
SPEED-Bus	-	-	-	✓
Technical data power supply				
Power supply (rated value)	DC 24 V	DC 24 V	DC 24 V	DC 24 V
Power supply (permitted range)	DC 20.4...28.8 V	DC 20.4...28.8 V	DC 20.4...28.8 V	DC 20.4...28.8 V
Reverse polarity protection	✓	✓	✓	✓
Current consumption (no-load operation)	135 mA	240 mA	200 mA	300 mA
Current consumption (rated value)	500 mA	700 mA	900 mA	1 A
Inrush current	11 A	11 A	11 A	5 A
I _{Δt}	0.7 A ² s	0.7 A ² s	0.7 A ² s	0.5 A ² s
Max. current drain at backplane bus	3 A	3 A	3 A	2.5 A
Power loss	8 W	14 W	14 W	14 W
Technical data digital inputs				
Number of inputs	16	24	16	8
Cable length, shielded	1000 m	1000 m	1000 m	1000 m
Cable length, unshielded	600 m	600 m	600 m	600 m
Rated load voltage	DC 24 V	DC 24 V	DC 24 V	DC 24 V
Reverse polarity protection of rated load voltage	✓	✓	✓	✓
Current consumption from load voltage L+ (without load)	70 mA	70 mA	70 mA	70 mA
Rated value	DC 24 V	DC 24 V	DC 24 V	DC 24 V
Input voltage for signal "0"	DC 0...5 V	DC 0...5 V	DC 0...5 V	DC 0...5 V
Input voltage for signal "1"	DC 15...28.8 V	DC 15...28.8 V	DC 15...28.8 V	DC 15...28.8 V
Input voltage hysteresis	-	-	-	-
Frequency range	-	-	-	-
Input resistance	-	-	-	-
Input current for signal "1"	6 mA	6 mA	6 mA	6 mA
Connection of Two-Wire-BERs possible	✓	✓	✓	✓
Max. permissible BERO quiescent current	1.5 mA	1.5 mA	1.5 mA	1.5 mA
Input delay of "0" to "1"	0.1 / 0.35 ms	0.1 / 0.35 ms	0.1 / 0.35 ms	parameterizable 2.56μs - 40ms

SLIO
100V
200V
300S
500S
HMI
Teleservice
StarterKits
Safety
Solutions
Software
Accessories
Appendix

CPU CPU STEP7 programmable, class C					
312-5BE13	314-6CF03				
313-5BF13	314-6CG13				
313-6CF13					
314-6CF02					

Order number	312-5BE13	313-5BF13	313-6CF13	314-6CF02
Input delay of "1" to "0"	0.1 / 0.35 ms	0.1 / 0.35 ms	0.1 / 0.35 ms	parameterizable 2.56µs - 40ms
Number of simultaneously utilizable inputs horizontal configuration	16	24	16	8
Number of simultaneously utilizable inputs vertical configuration	16	24	16	8
Input characteristic curve	IEC 61131-2, type 1	IEC 61131-2, type 1	IEC 61131-2, type 1	IEC 61131-2, type 1
Initial data size	2 Byte	3 Byte	2 Byte	34 Byte
Technical data digital outputs				
Number of outputs	8	16	16	8
Cable length, shielded	1000 m	1000 m	1000 m	1000 m
Cable length, unshielded	600 m	600 m	600 m	600 m
Rated load voltage	DC 24 V	DC 24 V	DC 24 V	DC 24 V
Reverse polarity protection of rated load voltage	-	-	-	-
Current consumption from load voltage L+ (without load)	100 mA	100 mA	100 mA	30 mA
Total current per group, horizontal configuration, 40°C	3 A	3 A	3 A	4 A
Total current per group, horizontal configuration, 60°C	2 A	2 A	2 A	3 A
Total current per group, vertical configuration	2 A	2 A	2 A	3 A
Output voltage signal "1" at min. current	L+ (-0.8 V)	L+ (-0.8 V)	L+ (-0.8 V)	L+ (-0.8 V)
Output voltage signal "1" at max. current	L+ (-0.8 V)	L+ (-0.8 V)	L+ (-0.8 V)	L+ (-0.8 V)
Output current at signal "1", rated value	0.5 A	0.5 A	0.5 A	0.5 A
Output current, permitted range to 40°C	5 mA to 0.6 A	5 mA to 0.6 A	5 mA to 0.6 A	5 mA to 0.6 A
Output current, permitted range to 60°C	5 mA to 0.6 A	5 mA to 0.6 A	5 mA to 0.6 A	5 mA to 0.6 A
Output current at signal "0" max. (residual current)	0.5 mA	0.5 mA	0.5 mA	100 µA
Output delay of "0" to "1"	100 µs	100 µs	100 µs	100 µs
Output delay of "1" to "0"	100 µs	100 µs	100 µs	100 µs
Minimum load current	-	-	-	-
Lamp load	5 W	5 W	5 W	5 W
Parallel switching of outputs for redundant control of a load	possible	possible	possible	possible
Parallel switching of outputs for increased power	not possible	not possible	not possible	not possible
Actuation of digital input	✓	✓	✓	✓
Switching frequency with resistive load	max. 2.5 kHz	max. 2.5 kHz	max. 2.5 kHz	max. 2.5 kHz
Switching frequency with inductive load	max. 0.5 Hz	max. 0.5 Hz	max. 0.5 Hz	max. 0.5 Hz
Switching frequency on lamp load	max. 2.5 kHz	max. 2.5 kHz	max. 2.5 kHz	max. 2.5 kHz
Internal limitation of inductive shut-off voltage	L+ (-52 V)	L+ (-52 V)	L+ (-52 V)	L+ (-52 V)
Short-circuit protection of output	yes, electronic	yes, electronic	yes, electronic	yes, electronic
Trigger level	1 A	1 A	1 A	1 A
Number of operating cycle of relay outputs	-	-	-	-
Switching capacity of contacts	-	-	-	-
Output data size	1 Byte	2 Byte	2 Byte	18 Byte

CPUs | CPUs STEP7 programmable, class C

312-5BE13 313-5BF13 313-6CF13 314-6CF02	314-6CF03 314-6CG13				
--	------------------------	--	--	--	--

Order number	312-5BE13	313-5BF13	313-6CF13	314-6CF02
Technical data analog inputs				
Number of inputs	-	5	-	5
Cable length, shielded	-	200 m	-	200 m
Rated load voltage	-	DC 24 V	-	DC 24 V
Reverse polarity protection of rated load voltage	-	✓	-	✓
Current consumption from load voltage L+ (without load)	-	-	-	85 mA
Voltage inputs	-	✓	-	✓
Min. input resistance (voltage range)	-	100 kΩ	-	120 kΩ
Input voltage ranges	-	0 V ... +10 V -10 V ... +10 V	-	-10 V ... +10 V 0 V ... +10 V
Operational limit of voltage ranges	-	+/-0.3%	-	+/-0.3%
Operational limit of voltage ranges with SFU	-	-	-	-
Basic error limit voltage ranges	-	+/-0.2%	-	+/-0.3%
Basic error limit voltage ranges with SFU	-	-	-	-
Destruction limit current	-	-	-	-
Current inputs	-	✓	-	✓
Max. input resistance (current range)	-	100 Ω	-	85 Ω
Input current ranges	-	0 mA ... +20 mA -20 mA ... +20 mA +4 mA ... +20 mA	-	-20 mA ... +20 mA 0 mA ... +20 mA +4 mA ... +20 mA
Operational limit of current ranges	-	+/-0.3%	-	+/-0.3%
Operational limit of current ranges with SFU	-	-	-	-
Basic error limit current ranges	-	+/-0.2%	-	+/-0.2%
Radical error limit current ranges with SFU	-	-	-	-
Destruction limit current inputs (electrical current)	-	-	-	-
Destruction limit current inputs (voltage)	-	-	-	-
Resistance inputs	-	✓	-	✓
Resistance ranges	-	0 ... 600 Ohm	-	0 ... 600 Ohm
Operational limit of resistor ranges	-	+/-0.4%	-	+/-0.4%
Operational limit of resistor ranges with SFU	-	-	-	-
Basic error limit	-	+/-0.2%	-	+/-0.2%
Basic error limit with SFU	-	-	-	-
Destruction limit resistance inputs	-	-	-	-
Resistance thermometer inputs	-	✓	-	✓
Resistance thermometer ranges	-	Pt100	-	Pt100 Pt1000 Ni100 Ni1000
Operational limit of resistance thermometer ranges	-	+/-0.6%	-	+/-0.6%
Operational limit of resistance thermometer ranges with SFU	-	-	-	-
Basic error limit thermoresistor ranges	-	+/-0.4%	-	+/-0.4%

CPUs CPUs STEP7 programmable, class C					
312-5BE13	314-6CF03				
313-5BF13	314-6CG13				
313-6CF13					
314-6CF02					

Order number	312-5BE13	313-5BF13	313-6CF13	314-6CF02
Basic error limit thermoresistor ranges with SFU	-	-	-	-
Destruction limit resistance thermometer inputs	-	-	-	-
Thermocouple inputs	-	-	-	-
Thermocouple ranges	-	-	-	-
Operational limit of thermocouple ranges	-	-	-	-
Operational limit of thermocouple ranges with SFU	-	-	-	-
Basic error limit thermoelement ranges	-	-	-	-
Basic error limit thermoelement ranges with SFU	-	-	-	-
Destruction limit thermocouple inputs	-	-	-	-
Programmable temperature compensation	-	-	-	-
External temperature compensation	-	-	-	-
Internal temperature compensation	-	-	-	-
Technical unit of temperature measurement	-	-	-	-
Resolution in bit	-	12	-	12
Measurement principle	-	successive approximation	-	Sigma-Delta
Basic conversion time	-	1 ms	-	6 ms
Noise suppression for frequency	-	80 dB	-	80 dB
Initial data size	-	10 Byte	-	10 Byte
Technical data analog outputs				
Number of outputs	-	2	-	2
Cable length, shielded	-	200 m	-	200 m
Rated load voltage	-	-	-	DC 24 V
Reverse polarity protection of rated load voltage	-	-	-	✓
Current consumption from load voltage L+ (without load)	-	-	-	-
Voltage output short-circuit protection	-	✓	-	-
Voltage outputs	-	✓	-	✓
Min. load resistance (voltage range)	-	1 kΩ	-	1 kΩ
Max. capacitive load (current range)	-	1 μF	-	1 μF
Max. inductive load (current range)	-	25 mA	-	30 mA
Output voltage ranges	-	-10 V ... +10 V 0 V ... +10 V	-	-10 V ... +10 V 0 V ... +10 V
Operational limit of voltage ranges	-	+/-0.2%	-	+/-0.4%
Basic error limit voltage ranges with SFU	-	+/-0.1%	-	+/-0.3%
Destruction limit against external applied voltage	-	-	-	-
Current outputs	-	✓	-	✓
Max. in load resistance (current range)	-	500 Ω	-	500 Ω
Max. inductive load (current range)	-	100 μH	-	10 mH
Max. inductive load (current range)	-	15 V	-	13 V

SLIO
100V
200V
300S
500S
HMI
Teleservice
StarterKits
Safety
Solutions
Software
Accessories
Appendix

CPUs | CPUs STEP7 programmable, class C

312-5BE13 313-5BF13 313-6CF13 314-6CF02	314-6CF03 314-6CG13				
--	------------------------	--	--	--	--

Order number	312-5BE13	313-5BF13	313-6CF13	314-6CF02
Output current ranges	-	-20 mA ... +20 mA 0 mA ... +20 mA +4 mA ... +20 mA	-	-20 mA ... +20 mA 0 mA ... +20 mA +4 mA ... +20 mA
Operational limit of current ranges	-	+/-0.3%	-	+/-0.4%
Radical error limit current ranges with SFU	-	+/-0.2%	-	+/-0.3%
Destruction limit against external applied voltage	-	-	-	-
Settling time for ohmic load	-	0.5 ms	-	0.2 ms
Settling time for capacitive load	-	0.5 ms	-	0.5 ms
Settling time for inductive load	-	0.5 ms	-	0.2 ms
Resolution in bit	-	12	-	12
Conversion time	-	1 ms	-	1 ms
Substitute value can be applied	-	no	-	yes
Output data size	-	4 Byte	-	4 Byte
Technical data counters				
Number of counters	2	3	3	4
Counter width	32 Bit	32 Bit	32 Bit	32 Bit
Maximum input frequency	10 kHz	30 kHz	30 kHz	100 kHz
Maximum count frequency	10 kHz	30 kHz	30 kHz	100 kHz
Mode incremental encoder	✓	✓	✓	✓
Mode pulse / direction	✓	✓	✓	✓
Mode pulse	✓	✓	✓	✓
Mode frequency counter	✓	✓	✓	-
Mode period measurement	✓	✓	✓	-
Gate input available	✓	✓	✓	✓
Latch input available	✓	✓	✓	✓
Reset input available	-	-	-	✓
Counter output available	✓	✓	✓	✓
Load and working memory				
Load memory, integrated	512 KB	512 KB	512 KB	2 MB
Load memory, maximum	512 KB	512 KB	512 KB	2 MB
Work memory, integrated	64 KB	128 KB	128 KB	512 KB
Work memory, maximal	512 KB	512 KB	512 KB	2 MB
Memory divided in 50% program / 50% data	✓	✓	✓	✓
Memory card slot	MMC-Card with max. 1 GB	MMC-Card with max. 1 GB	MMC-Card with max. 1 GB	MMC-Card with max. 1 GB
Hardware configuration				
Racks, max.	1	4	4	4
Modules per rack, max.	8	8	8	8 in multiple-, 32 in a single-rack configuration
Number of integrated DP master	0	0	1	1
Number of DP master via CP	4	4	4	4
Operable function modules	8	8	8	8
Operable communication modules PtP	8	8	8	8
Operable communication modules LAN	8	8	8	8

CPUs CPUs STEP7 programmable, class C					
312-5BE13	314-6CF03				
313-5BF13	314-6CG13				
313-6CF13					
314-6CF02					

Order number	312-5BE13	313-5BF13	313-6CF13	314-6CF02
Status information, alarms, diagnostics				
Status display	yes	yes	yes	yes
Interrupts	yes	yes	yes	yes
Process alarm	yes	yes	yes	no
Diagnostic interrupt	yes	yes	yes	yes, parameterizable
Diagnostic functions	no	no	no	yes
Diagnostics information read-out	possible	possible	possible	possible
Supply voltage display	green LED	green LED	green LED	green LED
Group error display	red SF LED	red SF LED	red SF LED	red SF LED
Channel error display	red LED per group	red LED per group	red LED per group	red LED per group
Command processing times				
Bit instructions, min.	0.02 µs	0.02 µs	0.02 µs	0.01 µs
Word instruction, min.	0.02 µs	0.02 µs	0.02 µs	0.01 µs
Double integer arithmetic, min.	0.02 µs	0.02 µs	0.02 µs	0.01 µs
Floating-point arithmetic, min.	0.12 µs	0.12 µs	0.12 µs	0.06 µs
Timers/Counters and their retentive characteristics				
Number of S7 counters	512	512	512	512
Number of S7 times	512	512	512	512
Data range and retentive characteristic				
Number of flags	8192 Byte	8192 Byte	8192 Byte	8192 Byte
Number of data blocks	4095	4095	4095	4095
Max. data blocks size	64 KB	64 KB	64 KB	64 KB
Max. local data size per execution level	510 Byte	510 Byte	510 Byte	510 Byte
Blocks				
Number of OBs	15	15	15	24
Number of FBs	2048	2048	2048	2048
Number of FCs	2048	2048	2048	2048
Maximum nesting depth per priority class	8	8	8	8
Maximum nesting depth additional within an error OB	4	4	4	4
Time				
Real-time clock buffered	✓	✓	✓	✓
Clock buffered period (min.)	6 w	6 w	6 w	6 w
Accuracy (max. deviation per day)	10 s	10 s	10 s	10 s
Number of operating hours counter	8	8	8	8
Clock synchronization	✓	✓	✓	✓
Synchronization via MPI	Master/Slave	Master/Slave	Master/Slave	Master/Slave
Synchronization via Ethernet (NTP)	no	no	no	no
Address areas (I/O)				
Input I/O address area	1024 Byte	1024 Byte	1024 Byte	8192 Byte
Output I/O address area	1024 Byte	1024 Byte	1024 Byte	8192 Byte
Input process image maximal	128 Byte	128 Byte	128 Byte	2048 Byte
Output process image maximal	128 Byte	128 Byte	128 Byte	2048 Byte
Digital inputs	272	1016	8064	65536
Digital outputs	264	1008	8064	65536

SLIO
100V
200V
300S
500S
HMI
Teleservice
StarterKits
Safety
Solutions
Software
Accessories
Appendix

CPUs CPUs STEP7 programmable, class C					
312-5BE13	314-6CF03				
313-5BF13	314-6CG13				
313-6CF13					
314-6CF02					

Order number	312-5BE13	313-5BF13	313-6CF13	314-6CF02
Digital inputs central	272	1016	1008	1032
Digital outputs central	264	1008	1008	1032
Integrated digital inputs	16	24	16	8
Integrated digital outputs	8	16	16	8
Analog inputs	64	253	503	1024
Analog outputs	64	250	503	1024
Analog inputs, central	64	253	248	261
Analog outputs, central	64	250	248	258
Integrated analog inputs	0	5	0	5
Integrated analog outputs	0	2	0	2
Communication functions				
PG/OP channel	✓	✓	✓	✓
Global data communication	✓	✓	✓	✓
Number of GD circuits, max.	4	4	4	4
Size of GD packets, max.	22 Byte	22 Byte	22 Byte	22 Byte
S7 basic communication	✓	✓	✓	✓
S7 basic communication, user data per job	76 Byte	76 Byte	76 Byte	76 Byte
S7 communication	✓	✓	✓	✓
S7 communication as server	✓	✓	✓	✓
S7 communication as client	-	-	-	-
S7 communication, user data per job	160 Byte	160 Byte	160 Byte	160 Byte
Number of connections, max.	32	32	32	32
PWM data				
PWM channels	2	3	3	-
PWM time basis	-	-	-	-
Period length	-	-	-	-
Minimum pulse width	-	-	-	-
PtP communication	-	-	-	-
Functionality Sub-D interfaces				
Type	X2	X2	X2	X2
Type of interface	RS485	RS485	RS485	RS485
Connector	Sub-D, 9-pin, female	Sub-D, 9-pin, female	Sub-D, 9-pin, female	Sub-D, 9-pin, female
Electrically isolated	-	-	-	✓
MPI	✓	✓	✓	✓
MP ² I (MPI/RS232)	-	-	-	-
DP master	-	-	-	-
DP slave	-	-	-	-
Point-to-point interface	-	-	-	-
Functionality Sub-D interfaces				
Type	X3	X3	X3	X3
Type of interface	RS485	RS485	RS485	RS485
Connector	Sub-D, 9-pin, female	Sub-D, 9-pin, female	Sub-D, 9-pin, female	Sub-D, 9-pin, female
Electrically isolated	✓	✓	✓	✓
MPI	-	-	-	-
MP ² I (MPI/RS232)	-	-	-	-

SLIO
100V
200V
300S
500S
HMI
Teleservice
StarterKits
Safety
Solutions
Software
Accessories
Appendix

CPUs CPU STEP7 programmable, class C					
312-5BE13	314-6CF03				
313-5BF13	314-6CG13				
313-6CF13					
314-6CF02					

Order number	312-5BE13	313-5BF13	313-6CF13	314-6CF02
DP master	-	-	yes	yes
DP slave	-	-	yes	yes
Point-to-point interface	✓	✓	✓	✓
Functionality MPI				
Number of connections, max.	32	32	32	32
PG/OP channel	✓	✓	✓	✓
Routing	-	-	✓	✓
Global data communication	✓	✓	✓	✓
S7 basic communication	✓	✓	✓	✓
S7 communication	✓	✓	✓	✓
S7 communication as server	✓	✓	✓	✓
S7 communication as client	-	-	-	-
Transmission speed, min.	19.2 kbit/s	19.2 kbit/s	19.2 kbit/s	19.2 kbit/s
Transmission speed, max.	187.5 kbit/s	187.5 kbit/s	187.5 kbit/s	12 Mbit/s
Functionality PROFIBUS master				
PG/OP channel	-	-	✓	✓
Routing	-	-	✓	✓
S7 basic communication	-	-	✓	✓
S7 communication	-	-	✓	✓
S7 communication as server	-	-	✓	✓
S7 communication as client	-	-	-	-
Activation/deactivation of DP slaves	-	-	✓	✓
Direct data exchange (slave-to-slave communication)	-	-	-	-
DPV1	-	-	✓	✓
Transmission speed, min.	-	-	9.6 kbit/s	9.6 kbit/s
Transmission speed, max.	-	-	12 Mbit/s	12 Mbit/s
Number of DP slaves, max.	-	-	32	124
Address range inputs, max.	-	-	1 KB	1 KB
Address range outputs, max.	-	-	1 KB	1 KB
User data inputs per slave, max.	-	-	244 Byte	244 Byte
User data outputs per slave, max.	-	-	244 Byte	244 Byte
Functionality PROFIBUS slave				
PG/OP channel	-	-	✓	✓
Routing	-	-	✓	✓
S7 communication	-	-	✓	✓
S7 communication as server	-	-	✓	✓
S7 communication as client	-	-	-	-
Direct data exchange (slave-to-slave communication)	-	-	-	-
DPV1	-	-	✓	✓
Transmission speed, min.	-	-	9.6 kbit/s	9.6 kbit/s
Transmission speed, max.	-	-	12 Mbit/s	12 Mbit/s
Automatic detection of transmission speed	-	-	-	-
Transfer memory inputs, max.	-	-	244 Byte	244 Byte
Transfer memory outputs, max.	-	-	244 Byte	244 Byte

CPUs CPUs STEP7 programmable, class C					
312-5BE13	314-6CF03				
313-5BF13	314-6CG13				
313-6CF13					
314-6CF02					

Order number	312-5BE13	313-5BF13	313-6CF13	314-6CF02
Address areas, max.	-	-	32	32
User data per address area, max.	-	-	32 Byte	32 Byte
Point-to-point communication				
PtP communication	✓	✓	✓	✓
Interface isolated	✓	✓	✓	✓
RS232 interface	-	-	-	-
RS422 interface	-	-	-	-
RS485 interface	✓	✓	✓	✓
Connector	Sub-D, 9-pin, female	Sub-D, 9-pin, female	Sub-D, 9-pin, female	Sub-D, 9-pin, female
Transmission speed, min.	150 bit/s	150 bit/s	150 bit/s	150 bit/s
Transmission speed, max.	115.5 kbit/s	115.5 kbit/s	115.5 kbit/s	115.5 kbit/s
Cable length, max.	500 m	500 m	500 m	500 m
Point-to-point protocol				
ASCII protocol	✓	✓	✓	✓
STX/ETX protocol	✓	✓	✓	✓
3964(R) protocol	✓	✓	✓	✓
RK512 protocol	-	-	-	-
USS master protocol	✓	✓	✓	✓
Modbus master protocol	✓	✓	✓	✓
Modbus slave protocol	-	-	-	-
Special protocols	-	-	-	-
Functionality RJ45 interfaces				
Type	X5	X5	X5	X5
Type of interface	Ethernet 10/100 MBit	Ethernet 10/100 MBit	Ethernet 10/100 MBit	Ethernet 10/100 MBit
Connector	RJ45	RJ45	RJ45	RJ45
Electrically isolated	✓	✓	✓	✓
PG/OP channel	✓	✓	✓	✓
Number of connections, max.	4	4	4	4
Productive connections	-	-	-	-
Housing				
Material	PPE	PPE	PPE	PPE
Mounting	Rail System 300	Rail System 300	Rail System 300	Rail System 300
Mechanical data				
Dimensions (WxHxD)	80 mm x 125 mm x 120 mm	120 mm x 125 mm x 120 mm	80 mm x 125 mm x 120 mm	80 mm x 125 mm x 120 mm
Weight	410 g	590 g	420 g	480 g
Environmental conditions				
Operating temperature	0 °C to 60 °C	0 °C to 60 °C	0 °C to 60 °C	0 °C to 60 °C
Storage temperature	-25 °C to 70 °C	-25 °C to 70 °C	-25 °C to 70 °C	-25 °C to 70 °C
Certifications				
UL508 certification	yes	yes	yes	yes

Connections, Interfaces

CPU | CPUs STEP7 programmable, class C

312-5BE13
313-5BF13
313-6CF13
314-6CF02

314-6CF03
314-6CG13

312-5BE13

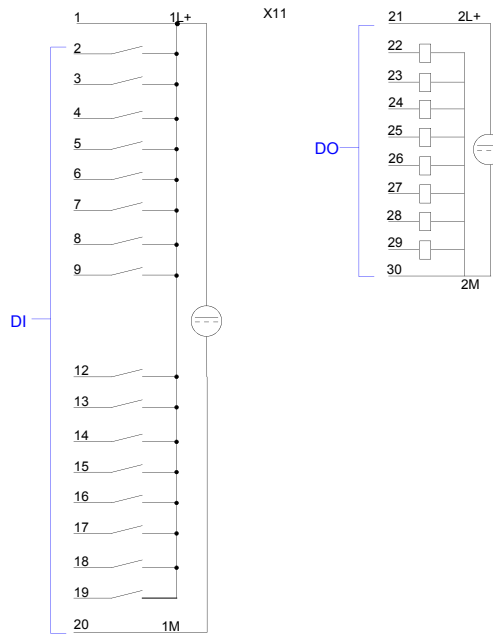
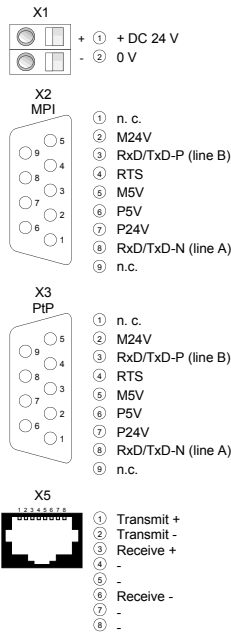
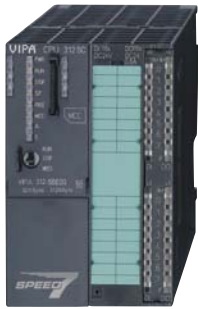

313-5BF13

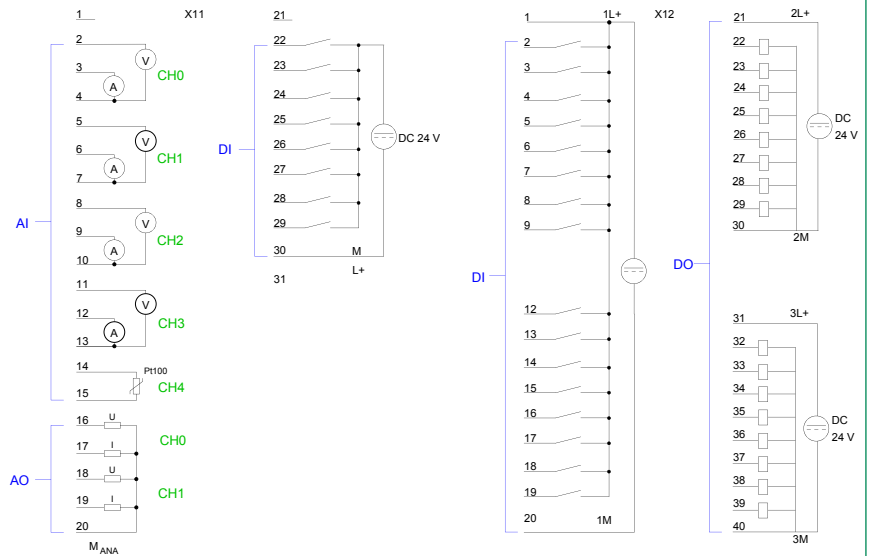
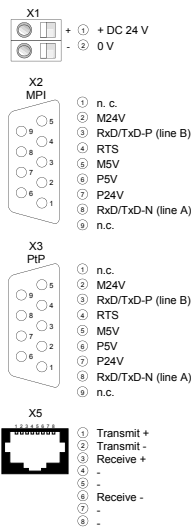
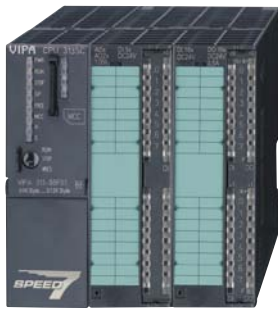

CPUs | CPUs STEP7 programmable, class C

312-5BE13
313-5BF13
313-6CF13
314-6CF02

314-6CF03
314-6CG13

313-6CF13

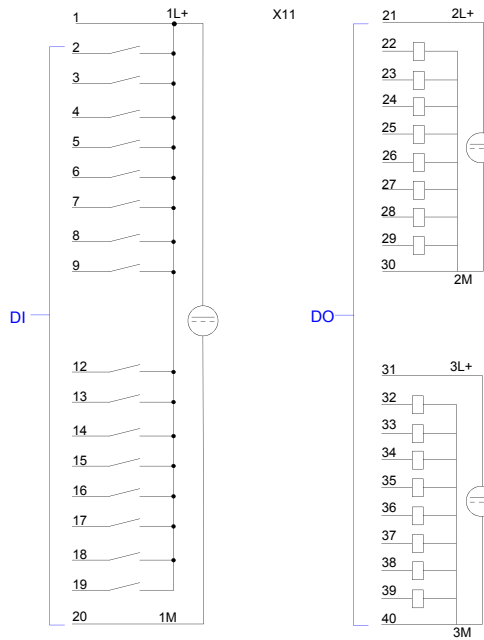
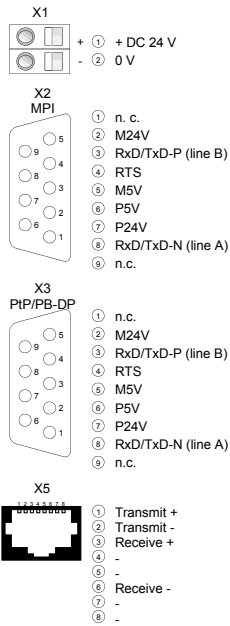

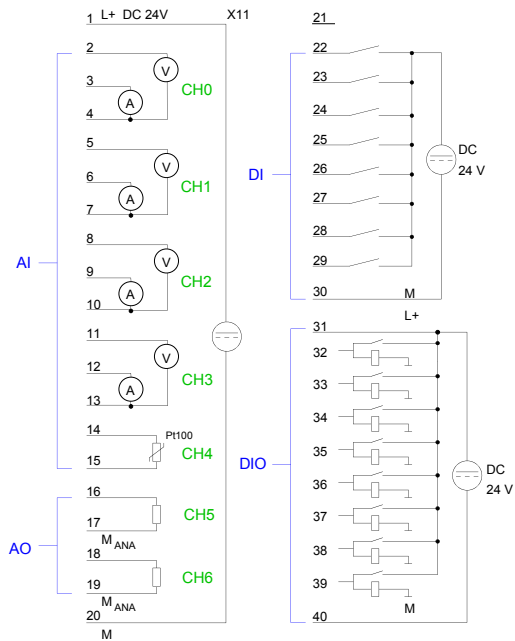
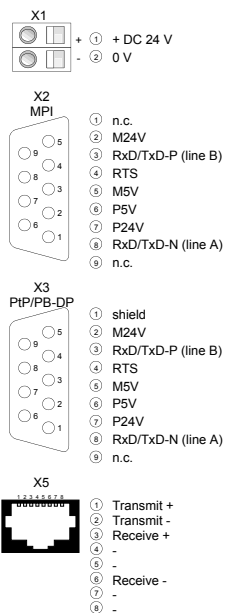
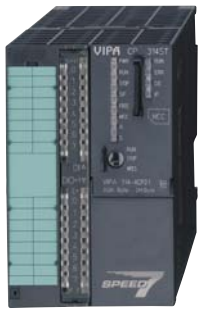

314-6CF02



CPUs STEP7 programmable, class C

CPUs CPUs STEP7 programmable, class C					
312-5BE13	314-6CF03				
313-5BF13	314-6CG13				
313-6CF13					
314-6CF02					

Order number	314-6CF03	314-6CG13		
Figure				
Type	CPU 314ST/DPM	CPU 314SC/DPM		
General information				
Note	-	-		
Features	<ul style="list-style-type: none"> ▶ SPEED7 technology, SPEED-Bus ▶ 8 x DI, 8 x DO, 4 x AI, 2 x AO, 1 x AI Pt100 ▶ 512 kB work memory ▶ Memory extension (max. 2 MB) ▶ PROFIBUS-DP master / PtP (switchable) ▶ Also configurable via TIA-Portal 	<ul style="list-style-type: none"> ▶ SPEED7 technology ▶ 24 x DI, 16 x DO, 8 x DIO, 4 x AI, 1 x AI Pt100, 2 x AO ▶ 256 kB work memory ▶ Memory extension (max. 1 MB) ▶ PROFIBUS-DP master / PtP (switchable) ▶ Also configurable via TIA-Portal 		
SPEED-Bus	✓	-		
Technical data power supply				
Power supply (rated value)	DC 24 V	DC 24 V		
Power supply (permitted range)	DC 20.4...28.8 V	DC 20.4...28.8 V		
Reverse polarity protection	✓	✓		
Current consumption (no-load operation)	300 mA	350 mA		
Current consumption (rated value)	1 A	1 A		
Inrush current	5 A	11 A		
I²t	0.5 A²s	0.7 A²s		
Max. current drain at backplane bus	2.5 A	3 A		
Power loss	14 W	14 W		
Technical data digital inputs				
Number of inputs	8	24		
Cable length, shielded	1000 m	1000 m		
Cable length, unshielded	600 m	600 m		
Rated load voltage	DC 24 V	DC 24 V		
Reverse polarity protection of rated load voltage	✓	✓		
Current consumption from load voltage L+ (without load)	70 mA	70 mA		
Rated value	DC 24 V	DC 24 V		
Input voltage for signal "0"	DC 0...5 V	DC 0...5 V		
Input voltage for signal "1"	DC 15...28.8 V	DC 15...28.8 V		
Input voltage hysteresis	-	-		
Frequency range	-	-		
Input resistance	-	-		
Input current for signal "1"	6 mA	6 mA		
Connection of Two-Wire-BEROs possible	✓	✓		
Max. permissible BERO quiescent current	1.5 mA	1.5 mA		

SLIO
100V
200V
300S
500S
HMI
Teleservice
StarterKits
Safety
Solutions
Software
Accessories
Appendix

CPUs | CPUs STEP7 programmable, class C

312-5BE13
313-5BF13
313-6CF13
314-6CF02

314-6CF03
314-6CG13

Order number	314-6CF03	314-6CG13		
Input delay of "0" to "1"	parameterizable 2.56µs - 40ms	0.1 / 0.35 ms		
Input delay of "1" to "0"	parameterizable 2.56µs - 40ms	0.1 / 0.35 ms		
Number of simultaneously utilizable inputs horizontal configuration	8	24		
Number of simultaneously utilizable inputs vertical configuration	8	24		
Input characteristic curve	IEC 61131-2, type 1	IEC 61131-2, type 1		
Initial data size	34 Byte	3 Byte		
Technical data digital outputs				
Number of outputs	8	16		
Cable length, shielded	1000 m	1000 m		
Cable length, unshielded	600 m	600 m		
Rated load voltage	DC 24 V	DC 24 V		
Reverse polarity protection of rated load voltage	-	-		
Current consumption from load voltage L+ (without load)	30 mA	100 mA		
Total current per group, horizontal configu- ration, 40°C	4 A	3 A		
Total current per group, horizontal configu- ration, 60°C	3 A	2 A		
Total current per group, vertical configu- ration	3 A	2 A		
Output voltage signal "1" at min. current	L+ (-0.8 V)	L+ (-0.8 V)		
Output voltage signal "1" at max. current	L+ (-0.8 V)	L+ (-0.8 V)		
Output current at signal "1", rated value	0.5 A	0.5 A		
Output current, permitted range to 40°C	5 mA to 0.6 A	5 mA to 0.6 A		
Output current, permitted range to 60°C	5 mA to 0.6 A	5 mA to 0.6 A		
Output current at signal "0" max. (residual current)	100 µA	0.5 mA		
Output delay of "0" to "1"	100 µs	100 µs		
Output delay of "1" to "0"	100 µs	100 µs		
Minimum load current	-	-		
Lamp load	5 W	5 W		
Parallel switching of outputs for redundant control of a load	possible	possible		
Parallel switching of outputs for increased power	not possible	not possible		
Actuation of digital input	✓	✓		
Switching frequency with resistive load	max. 2.5 kHz	max. 2.5 kHz		
Switching frequency with inductive load	max. 0.5 Hz	max. 0.5 Hz		
Switching frequency on lamp load	max. 2.5 kHz	max. 2.5 kHz		
Internal limitation of inductive shut-off voltage	L+ (-52 V)	L+ (-52 V)		
Short-circuit protection of output	yes, electronic	yes, electronic		
Trigger level	1 A	1 A		
Number of operating cycle of relay outputs	-	-		

CPUs CPUs STEP7 programmable, class C					
312-5BE13	314-6CF03				
313-5BF13	314-6CG13				
313-6CF13					
314-6CF02					

Order number	314-6CF03	314-6CG13		
Switching capacity of contacts	-	-		
Output data size	18 Byte	2 Byte		
Technical data analog inputs				
Number of inputs	5	5		
Cable length, shielded	200 m	200 m		
Rated load voltage	DC 24 V	DC 24 V		
Reverse polarity protection of rated load voltage	✓	✓		
Current consumption from load voltage L+ (without load)	85 mA	-		
Voltage inputs	✓	✓		
Min. input resistance (voltage range)	120 kΩ	100 kΩ		
Input voltage ranges	-10 V ... +10 V 0 V ... +10 V	-10 V ... +10 V 0 V ... +10 V		
Operational limit of voltage ranges	+/-0.3%	+/-0.3%		
Operational limit of voltage ranges with SFU	-	-		
Basic error limit voltage ranges	+/-0.3%	+/-0.2%		
Basic error limit voltage ranges with SFU	-	-		
Destruction limit current	-	-		
Current inputs	✓	✓		
Max. input resistance (current range)	85 Ω	100 Ω		
Input current ranges	-20 mA ... +20 mA 0 mA ... +20 mA +4 mA ... +20 mA	-20 mA ... +20 mA 0 mA ... +20 mA +4 mA ... +20 mA		
Operational limit of current ranges	+/-0.3%	+/-0.3%		
Operational limit of current ranges with SFU	-	-		
Basic error limit current ranges	+/-0.2%	+/-0.2%		
Radical error limit current ranges with SFU	-	-		
Destruction limit current inputs (electrical current)	-	-		
Destruction limit current inputs (voltage)	-	-		
Resistance inputs	✓	✓		
Resistance ranges	0 ... 600 Ohm	0 ... 600 Ohm		
Operational limit of resistor ranges	+/-0.4%	+/-0.4%		
Operational limit of resistor ranges with SFU	-	-		
Basic error limit	+/-0.2%	+/-0.2%		
Basic error limit with SFU	-	-		
Destruction limit resistance inputs	-	-		
Resistance thermometer inputs	✓	-		
Resistance thermometer ranges	Pt100 Pt1000 Ni100 Ni1000	Pt100		
Operational limit of resistance thermometer ranges	+/-0.6%	+/-0.6%		
Operational limit of resistance thermometer ranges with SFU	-	-		

CPUs CPUs STEP7 programmable, class C					
312-5BE13	314-6CF03				
313-5BF13	314-6CG13				
313-6CF13					
314-6CF02					

Order number	314-6CF03	314-6CG13		
Basic error limit thermoresistor ranges	+/-0.4%	+/-0.4%		
Basic error limit thermoresistor ranges with SFU	-	-		
Destruction limit resistance thermometer inputs	-	-		
Thermocouple inputs	-	-		
Thermocouple ranges	-	-		
Operational limit of thermocouple ranges	-	-		
Operational limit of thermocouple ranges with SFU	-	-		
Basic error limit thermoelement ranges	-	-		
Basic error limit thermoelement ranges with SFU	-	-		
Destruction limit thermocouple inputs	-	-		
Programmable temperature compensation	-	-		
External temperature compensation	-	-		
Internal temperature compensation	-	-		
Technical unit of temperature measurement	-	-		
Resolution in bit	12	12		
Measurement principle	Sigma-Delta	successive approximation		
Basic conversion time	6 ms	0.5 ms		
Noise suppression for frequency	80 dB	80 dB		
Initial data size	10 Byte	10 Byte		
Technical data analog outputs				
Number of outputs	2	2		
Cable length, shielded	200 m	200 m		
Rated load voltage	DC 24 V	-		
Reverse polarity protection of rated load voltage	✓	-		
Current consumption from load voltage L+ (without load)	-	-		
Voltage output short-circuit protection	-	✓		
Voltage outputs	✓	✓		
Min. load resistance (voltage range)	1 kΩ	1 kΩ		
Max. capacitive load (current range)	1 μF	1 μF		
Max. inductive load (current range)	30 mA	25 mA		
Output voltage ranges	-10 V ... +10 V 0 V ... +10 V	-10 V ... +10 V 0 V ... +10 V		
Operational limit of voltage ranges	+/-0.4%	+/-0.2%		
Basic error limit voltage ranges with SFU	+/-0.3%	+/-0.1%		
Destruction limit against external applied voltage	-	-		
Current outputs	✓	✓		
Max. in load resistance (current range)	500 Ω	500 Ω		
Max. inductive load (current range)	10 mH	10 mH		
Max. inductive load (current range)	13 V	15 V		

- SLIO
- 100V
- 200V
- 300S
- 500S
- HMI
- Teleservice
- StarterKits
- Safety
- Solutions
- Software
- Accessories
- Appendix

CPUs CPUs STEP7 programmable, class C					
312-5BE13	314-6CF03				
313-5BF13	314-6CG13				
313-6CF13					
314-6CF02					

Order number	314-6CF03	314-6CG13		
Output current ranges	-20 mA ... +20 mA 0 mA ... +20 mA +4 mA ... +20 mA	-20 mA ... +20 mA 0 mA ... +20 mA +4 mA ... +20 mA		
Operational limit of current ranges	+/-0.4%	+/-0.3%		
Radical error limit current ranges with SFU	+/-0.3%	+/-0.2%		
Destruction limit against external applied voltage	-	-		
Settling time for ohmic load	0.2 ms	0.5 ms		
Settling time for capacitive load	0.5 ms	0.5 ms		
Settling time for inductive load	0.2 ms	0.5 ms		
Resolution in bit	12	12		
Conversion time	1 ms	1 ms		
Substitute value can be applied	yes	no		
Output data size	4 Byte	4 Byte		
Technical data counters				
Number of counters	4	4		
Counter width	32 Bit	32 Bit		
Maximum input frequency	100 kHz	60 kHz		
Maximum count frequency	100 kHz	60 kHz		
Mode incremental encoder	✓	✓		
Mode pulse / direction	✓	✓		
Mode pulse	✓	✓		
Mode frequency counter	-	✓		
Mode period measurement	-	✓		
Gate input available	✓	✓		
Latch input available	✓	✓		
Reset input available	✓	-		
Counter output available	✓	✓		
Load and working memory				
Load memory, integrated	2 MB	1 MB		
Load memory, maximum	2 MB	1 MB		
Work memory, integrated	512 KB	256 KB		
Work memory, maximal	2 MB	1 MB		
Memory divided in 50% program / 50% data	✓	✓		
Memory card slot	MMC-Card with max. 1 GB	MMC-Card with max. 1 GB		
Hardware configuration				
Racks, max.	4	4		
Modules per rack, max.	8 in multiple-, 32 in a single-rack configuration	8		
Number of integrated DP master	1	1		
Number of DP master via CP	4	4		
Operable function modules	8	8		
Operable communication modules PtP	8	8		
Operable communication modules LAN	8	8		

SLIO
100V
200V
300S
500S
HMI
Teleservice
StarterKits
Safety
Solutions
Software
Accessories
Appendix

CPUs CPUs STEP7 programmable, class C					
312-5BE13	314-6CF03				
313-5BF13	314-6CG13				
313-6CF13					
314-6CF02					

Order number	314-6CF03	314-6CG13		
Status information, alarms, diagnostics				
Status display	yes	yes		
Interrupts	yes	yes		
Process alarm	no	yes		
Diagnostic interrupt	yes, parameterizable	yes		
Diagnostic functions	yes	no		
Diagnostics information read-out	possible	possible		
Supply voltage display	green LED	green LED		
Group error display	red SF LED	red SF LED		
Channel error display	red LED per group	red LED per group		
Command processing times				
Bit instructions, min.	0.01 µs	0.01 µs		
Word instruction, min.	0.01 µs	0.01 µs		
Double integer arithmetic, min.	0.01 µs	0.01 µs		
Floating-point arithmetic, min.	0.06 µs	0.06 µs		
Timers/Counters and their retentive characteristics				
Number of S7 counters	512	512		
Number of S7 times	512	512		
Data range and retentive characteristic				
Number of flags	8192 Byte	8192 Byte		
Number of data blocks	4095	4095		
Max. data blocks size	64 KB	64 KB		
Max. local data size per execution level	1024 Byte	510 Byte		
Blocks				
Number of OBs	23	15		
Number of FBs	2048	2048		
Number of FCs	2048	2048		
Maximum nesting depth per priority class	8	8		
Maximum nesting depth additional within an error OB	4	4		
Time				
Real-time clock buffered	✓	✓		
Clock buffered period (min.)	6 w	6 w		
Accuracy (max. deviation per day)	10 s	10 s		
Number of operating hours counter	8	8		
Clock synchronization	✓	✓		
Synchronization via MPI	Master/Slave	Master/Slave		
Synchronization via Ethernet (NTP)	no	no		
Address areas (I/O)				
Input I/O address area	8192 Byte	1024 Byte		
Output I/O address area	8192 Byte	1024 Byte		
Input process image maximal	2048 Byte	128 Byte		
Output process image maximal	2048 Byte	128 Byte		
Digital inputs	65536	7856		
Digital outputs	65536	7904		

SLIO
100V
200V
300S
500S
HMI
Teleservice
StarterKits
Safety
Solutions
Software
Accessories
Appendix

CPU CPU STEP7 programmable, class C					
312-5BE13	314-6CF03				
313-5BF13	314-6CG13				
313-6CF13					
314-6CF02					

Order number	314-6CF03	314-6CG13		
Digital inputs central	1032	979		
Digital outputs central	1032	986		
Integrated digital inputs	8	24 32		
Integrated digital outputs	8	16 24		
Analog inputs	1024	494		
Analog outputs	1024	495		
Analog inputs, central	261	253		
Analog outputs, central	258	250		
Integrated analog inputs	5	5		
Integrated analog outputs	2	2		
Communication functions				
PG/OP channel	✓	✓		
Global data communication	✓	✓		
Number of GD circuits, max.	4	4		
Size of GD packets, max.	22 Byte	22 Byte		
S7 basic communication	✓	✓		
S7 basic communication, user data per job	76 Byte	76 Byte		
S7 communication	✓	✓		
S7 communication as server	✓	✓		
S7 communication as client	-	-		
S7 communication, user data per job	160 Byte	160 Byte		
Number of connections, max.	32	32		
PWM data				
PWM channels	-	4		
PWM time basis	-	-		
Period length	-	-		
Minimum pulse width	-	-		
PtP communication	-	-		
Functionality Sub-D interfaces				
Type	X2	X2		
Type of interface	RS485	RS485		
Connector	Sub-D, 9-pin, female	Sub-D, 9-pin, female		
Electrically isolated	✓	-		
MPI	✓	✓		
MP ² I (MPI/RS232)	-	-		
DP master	-	-		
DP slave	-	-		
Point-to-point interface	-	✓		
Functionality Sub-C interfaces				
Type	X3	X3		
Type of interface	RS485	RS485		
Connector	Sub-D, 9-pin, female	Sub-D, 9-pin, female		
Electrically isolated	✓	✓		
MPI	-	-		

CPUs CPUs STEP7 programmable, class C					
312-5BE13	314-6CF03				
313-5BF13	314-6CG13				
313-6CF13					
314-6CF02					

Order number	314-6CF03	314-6CG13		
MP ² I (MPI/RS232)	-	-		
DP master	yes	yes		
DP slave	yes	yes		
Point-to-point interface	✓	✓		
Functionality MPI				
Number of connections, max.	32	32		
PG/OP channel	✓	✓		
Routing	✓	✓		
Global data communication	✓	✓		
S7 basic communication	✓	✓		
S7 communication	✓	✓		
S7 communication as server	✓	✓		
S7 communication as client	-	-		
Transmission speed, min.	19.2 kbit/s	19.2 kbit/s		
Transmission speed, max.	12 Mbit/s	187.5 kbit/s		
Functionality PROFIBUS master				
PG/OP channel	✓	✓		
Routing	✓	✓		
S7 basic communication	✓	✓		
S7 communication	✓	✓		
S7 communication as server	✓	✓		
S7 communication as client	-	-		
Activation/deactivation of DP slaves	✓	✓		
Direct data exchange (slave-to-slave communication)	-	-		
DPV1	✓	✓		
Transmission speed, min.	9.6 kbit/s	9.6 kbit/s		
Transmission speed, max.	12 Mbit/s	12 Mbit/s		
Number of DP slaves, max.	124	32		
Address range inputs, max.	1 KB	1 KB		
Address range outputs, max.	1 KB	1 KB		
User data inputs per slave, max.	244 Byte	244 Byte		
User data outputs per slave, max.	244 Byte	244 Byte		
Functionality PROFIBUS slave				
PG/OP channel	✓	✓		
Routing	✓	✓		
S7 communication	✓	✓		
S7 communication as server	✓	✓		
S7 communication as client	-	-		
Direct data exchange (slave-to-slave communication)	-	-		
DPV1	✓	✓		
Transmission speed, min.	9.6 kbit/s	9.6 kbit/s		
Transmission speed, max.	12 Mbit/s	12 Mbit/s		
Automatic detection of transmission speed	-	-		
Transfer memory inputs, max.	244 Byte	244 Byte		

SLIO
100V
200V
300S
500S
HMI
Teleservice
StarterKits
Safety
Solutions
Software
Accessories
Appendix

CPUs CPUs STEP7 programmable, class C					
312-5BE13	314-6CF03				
313-5BF13	314-6CG13				
313-6CF13					
314-6CF02					

Order number	314-6CF03	314-6CG13		
Transfer memory outputs, max.	244 Byte	244 Byte		
Address areas, max.	32	32		
User data per address area, max.	32 Byte	32 Byte		
Point-to-point communication				
PtP communication	✓	✓		
Interface isolated	✓	✓		
RS232 interface	-	-		
RS422 interface	-	-		
RS485 interface	✓	✓		
Connector	Sub-D, 9-pin, female	Sub-D, 9-pin, female		
Transmission speed, min.	150 bit/s	150 bit/s		
Transmission speed, max.	115.5 kbit/s	115.5 kbit/s		
Cable length, max.	500 m	500 m		
Point-to-point protocol				
ASCII protocol	✓	✓		
STX/ETX protocol	✓	✓		
3964(R) protocol	✓	✓		
RK512 protocol	-	-		
USS master protocol	✓	✓		
Modbus master protocol	✓	✓		
Modbus slave protocol	-	-		
Special protocols	-	-		
Functionality RJ45 interfaces				
Type	X5	X5		
Type of interface	Ethernet 10/100 MBit	Ethernet 10/100 MBit		
Connector	RJ45	RJ45		
Electrically isolated	✓	✓		
PG/OP channel	✓	✓		
Number of connections, max.	4	4		
Productive connections	-	-		
Housing				
Material	PPE	PPE		
Mounting	Rail System 300	Rail System 300		
Mechanical data				
Dimensions (WxHxD)	80 mm x 125 mm x 120 mm	120 mm x 125 mm x 120 mm		
Weight	480 g	610 g		
Environmental conditions				
Operating temperature	0 °C to 60 °C	0 °C to 60 °C		
Storage temperature	-25 °C to 70 °C	-25 °C to 70 °C		
Certifications				
UL508 certification	yes	yes		

SLIO
100V
200V
300S
500S
HMI
Teleservice
StarterKits
Safety
Solutions
Software
Accessories
Appendix

Connections, Interfaces

CPUs | CPUs STEP7 programmable, class C

312-5BE13
313-5BF13
313-6CF13
314-6CF02

314-6CF03
314-6CG13

314-6CF03

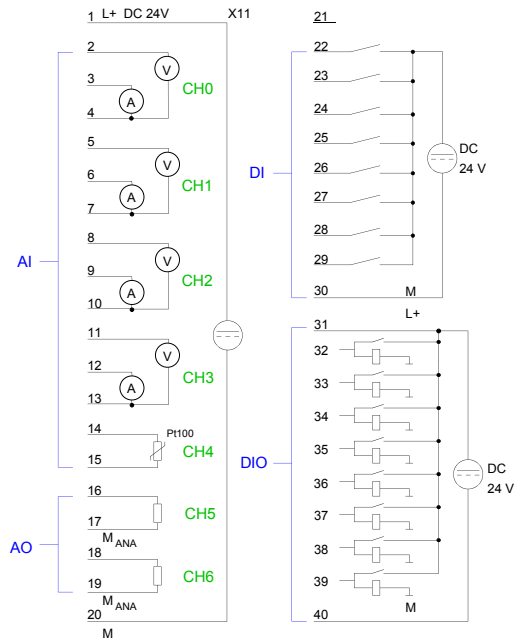
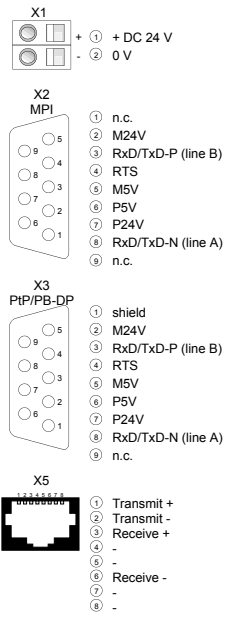
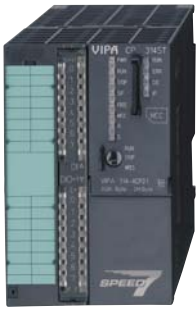

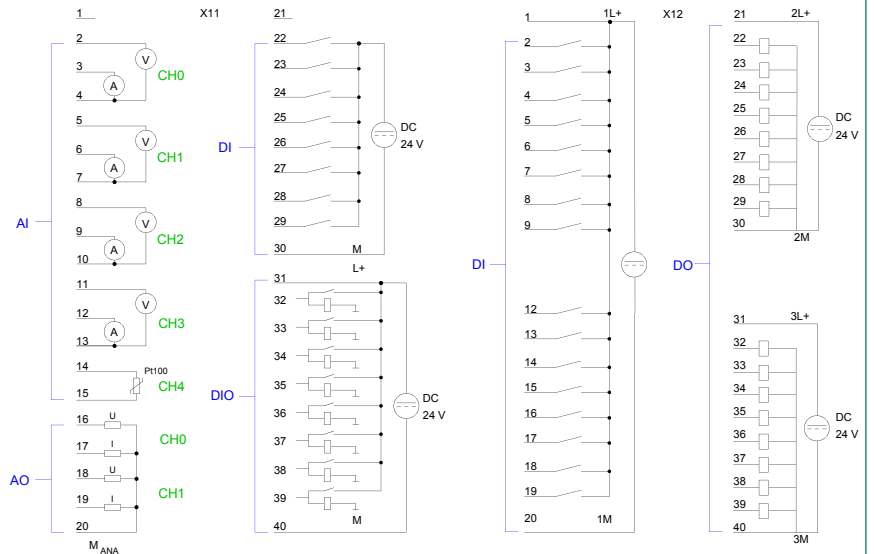
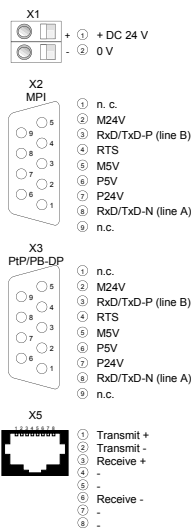
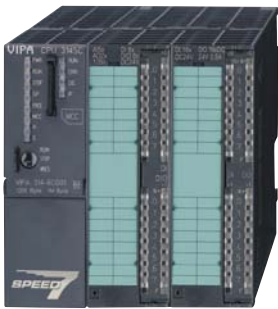

314-6CG13



SLIO
100V
200V
300S
500S
HMI
Teleservice
StarterKits
Safety
Solutions
Software
Accessories
Appendix

CPUs STEP7 programmable, EtherCAT

CPUs CPUs STEP7 programmable, EtherCAT					
315-4EC12					
317-4EC12					

Order number	315-4EC12	317-4EC12		
Figure				
Type	CPU 315SN/EC	CPU 317SN/EC		
General information				
Note	-	-		
Features	<ul style="list-style-type: none"> ▸ SPEED7 technology ▸ 1 MB work memory ▸ Memory extension (max. 2 MB) ▸ PROFIBUS-DP master / PtP (switchable) ▸ EtherCAT controller integrated 	<ul style="list-style-type: none"> ▸ SPEED7 technology, SPEED-Bus ▸ 2 MB work memory ▸ Memory extension (max. 8 MB) ▸ PROFIBUS-DP master / PtP (switchable) ▸ EtherCAT-Master integrated 		
SPEED-Bus	-	✓		
Technical data power supply				
Power supply (rated value)	DC 24 V	DC 24 V		
Power supply (permitted range)	DC 20.4...28.8 V	DC 20.4...28.8 V		
Reverse polarity protection	✓	✓		
Current consumption (no-load operation)	270 mA	270 mA		
Current consumption (rated value)	1.1 A	1.5 A		
Inrush current	6 A	6 A		
I ² t	0.28 A ² s	0.28 A ² s		
Max. current drain at backplane bus	2.5 A	4 A		
Power loss	8.5 W	10 W		
Load and working memory				
Load memory, integrated	2 MB	8 MB		
Load memory, maximum	2 MB	8 MB		
Work memory, integrated	1 MB	2 MB		
Work memory, maximal	2 MB	8 MB		
Memory divided in 50% program / 50% data	✓	✓		
Memory card slot	MMC-Card with max. 1 GB	MMC-Card with max. 1 GB		
Hardware configuration				
Racks, max.	4	4		
Modules per rack, max.	8 in multiple-, 32 in a single-rack configuration	8 in multiple-, 32 in a single-rack configuration		
Number of integrated DP master	1	1		
Number of DP master via CP	4	4		
Operable function modules	8	8		
Operable communication modules PtP	8	16		
Operable communication modules LAN	8	8		

SLIO
100V
200V
300S
500S
HMI
Teleservice
StarterKits
Safety
Solutions
Software
Accessories
Appendix

CPUs CPUs STEP7 programmable, EtherCAT					
315-4EC12					
317-4EC12					

Order number	315-4EC12	317-4EC12		
Command processing times				
Bit instructions, min.	0.01 µs	0.01 µs		
Word instruction, min.	0.01 µs	0.01 µs		
Double integer arithmetic, min.	0.01 µs	0.01 µs		
Floating-point arithmetic, min.	0.06 µs	0.06 µs		
Timers/Counters and their retentive characteristics				
Number of S7 counters	512	2048		
S7 counter remanence	adjustable 0 up to 512	adjustable 0 up to 2048		
S7 counter remanence adjustable	C0 .. C7	C0 .. C7		
Number of S7 times	512	2048		
S7 times remanence	adjustable 0 up to 512	adjustable 0 up to 2048		
S7 times remanence adjustable	not retentive	not retentive		
Data range and retentive characteristic				
Number of flags	8192 Byte	16384 Byte		
Bit memories retentive characteristic adjustable	adjustable 0 up to 8192	adjustable 0 up to 16384		
Bit memories retentive characteristic preset	MB0 .. MB15	MB0 .. MB15		
Number of data blocks	4095	8190		
Max. data blocks size	64 KB	64 KB		
Number range DBs	1 ... 4095	1 ... 8190		
Max. local data size per execution level	3072 Byte	3072 Byte		
Max. local data size per block	3072 Byte	3072 Byte		
Blocks				
Number of OBs	24	24		
Maximum OB size	64 KB	64 KB		
Totalnumber DBs, FBs, FCs	-	-		
Number of FBs	2048	8191		
Maximum FB size	64 KB	64 KB		
Number range FBs	0 ... 2047	0 ... 8190		
Number of FCs	2048	8191		
Maximum FC size	64 KB	64 KB		
Number range FC2	0 ... 2047	0 ... 8190		
Maximum nesting depth per priority class	8	16		
Maximum nesting depth additional within an error OB	4	4		
Time				
Real-time clock buffered	✓	✓		
Clock buffered period (min.)	6 w	6 w		
Type of buffering	-	-		
Load time for 50% buffering period	20 h	20 h		
Load time for 100% buffering period	48 h	48 h		
Accuracy (max. deviation per day)	10 s	10 s		
Number of operating hours counter	8	8		
Clock synchronization	✓	✓		
Synchronization via MPI	Master/Slave	Master/Slave		
Synchronization via Ethernet (NTP)	Slave	Slave		

SLIO
100V
200V
300S
500S
HMI
Teleservice
StarterKits
Safety
Solutions
Software
Accessories
Appendix

CPUs CPUs STEP7 programmable, EtherCAT					
315-4EC12					
317-4EC12					

Order number	315-4EC12	317-4EC12		
Address areas (I/O)				
Input I/O address area	2048 Byte	8192 Byte		
Output I/O address area	2048 Byte	8192 Byte		
Process image adjustable	✓	✓		
Input process image preset	128 Byte	256 Byte		
Output process image preset	128 Byte	256 Byte		
Input process image maximal	2048 Byte	8192 Byte		
Output process image maximal	2048 Byte	8192 Byte		
Digital inputs	16384	65536		
Digital outputs	16384	65536		
Digital inputs central	1024	1024		
Digital outputs central	1024	1024		
Integrated digital inputs	-	-		
Integrated digital outputs	-	-		
Analog inputs	1024	4096		
Analog outputs	1024	4096		
Analog inputs, central	256	256		
Analog outputs, central	256	256		
Integrated analog inputs	-	-		
Integrated analog outputs	-	-		
Communication functions				
PG/OP channel	✓	✓		
Global data communication	✓	✓		
Number of GD circuits, max.	8	8		
Size of GD packets, max.	22 Byte	22 Byte		
S7 basic communication	✓	✓		
S7 basic communication, user data per job	76 Byte	76 Byte		
S7 communication	✓	✓		
S7 communication as server	✓	✓		
S7 communication as client	-	-		
S7 communication, user data per job	160 Byte	160 Byte		
Number of connections, max.	32	32		
Functionality Sub-D interfaces				
Type	X2	X2		
Type of interface	RS485	RS485		
Connector	Sub-D, 9-pin, female	Sub-D, 9-pin, female		
Electrically isolated	✓	✓		
MPI	✓	✓		
MP ² I (MPI/RS232)	-	-		
DP master	-	-		
DP slave	-	-		
Point-to-point interface	-	-		

SLIO
100V
200V
300S
500S
HMI
Teleservice
StarterKits
Safety
Solutions
Software
Accessories
Appendix

CPUs CPUs STEP7 programmable, EtherCAT					
315-4EC12					
317-4EC12					

Order number	315-4EC12	317-4EC12		
Type	X3	X3		
Type of interface	RS485	RS485		
Connector	Sub-D, 9-pin, female	Sub-D, 9-pin, female		
Electrically isolated	✓	✓		
MPI	-	-		
MP ² I (MPI/RS232)	-	-		
DP master	yes	yes		
DP slave	yes	yes		
Point-to-point interface	✓	✓		
Functionality MPI				
Number of connections, max.	32	32		
PG/OP channel	✓	✓		
Routing	✓	✓		
Global data communication	✓	✓		
S7 basic communication	✓	✓		
S7 communication	✓	✓		
S7 communication as server	✓	✓		
S7 communication as client	-	-		
Transmission speed, min.	19.2 kbit/s	19.2 kbit/s		
Transmission speed, max.	12 Mbit/s	12 Mbit/s		
Functionality PROFIBUS master				
PG/OP channel	✓	✓		
Routing	✓	✓		
S7 basic communication	✓	✓		
S7 communication	✓	✓		
S7 communication as server	✓	✓		
S7 communication as client	-	-		
Activation/deactivation of DP slaves	✓	✓		
Direct data exchange (slave-to-slave communication)	-	-		
DPV1	✓	✓		
Transmission speed, min.	9.6 kbit/s	9.6 kbit/s		
Transmission speed, max.	12 Mbit/s	12 Mbit/s		
Number of DP slaves, max.	124	124		
Address range inputs, max.	8 KB	8 KB		
Address range outputs, max.	8 KB	8 KB		
User data inputs per slave, max.	244 Byte	244 Byte		
User data outputs per slave, max.	244 Byte	244 Byte		
Functionality PROFIBUS slave				
PG/OP channel	✓	✓		
Routing	✓	✓		
S7 communication	✓	✓		
S7 communication as server	✓	✓		
S7 communication as client	-	-		

CPUs CPUs STEP7 programmable, EtherCAT					
315-4EC12					
317-4EC12					

Order number	315-4EC12	317-4EC12		
Direct data exchange (slave-to-slave communication)	-	-		
DPV1	✓	✓		
Transmission speed, min.	9.6 kbit/s	9.6 kbit/s		
Transmission speed, max.	12 Mbit/s	12 Mbit/s		
Automatic detection of transmission speed	-	-		
Transfer memory inputs, max.	244 Byte	244 Byte		
Transfer memory outputs, max.	244 Byte	244 Byte		
Address areas, max.	32	32		
User data per address area, max.	32 Byte	32 Byte		
Point-to-point communication				
PtP communication	✓	✓		
Interface isolated	✓	✓		
RS232 interface	-	-		
RS422 interface	-	-		
RS485 interface	✓	✓		
Connector	Sub-D, 9-pin, female	Sub-D, 9-pin, female		
Transmission speed, min.	1200 bit/s	1200 bit/s		
Transmission speed, max.	115.5 kbit/s	115.5 kbit/s		
Cable length, max.	500 m	500 m		
Point-to-point protocol				
ASCII protocol	✓	✓		
STX/ETX protocol	✓	✓		
3964(R) protocol	✓	✓		
RK512 protocol	-	-		
USS master protocol	✓	✓		
Modbus master protocol	✓	✓		
Modbus slave protocol	-	-		
Special protocols	-	-		
Functionality RJ45 interfaces				
Type	X5	X5		
Type of interface	Ethernet 10/100 MBit	Ethernet 10/100 MBit		
Connector	RJ45	RJ45		
Electrically isolated	✓	✓		
PG/OP channel	✓	✓		
Number of connections, max.	4	4		
Productive connections	-	-		
Type	X8	X8		
Type of interface	Ethernet 10/100 MBit	Ethernet 10/100 MBit		
Connector	RJ45	RJ45		
Electrically isolated	✓	✓		
PG/OP channel	✓	✓		
Number of connections, max.	8	8		
Productive connections	✓	✓		

CPUs CPUs STEP7 programmable, EtherCAT						
315-4EC12 317-4EC12						

Order number	315-4EC12	317-4EC12		
Ethernet communication CP				
Number of productive connections, max.	8	24		
Number of productive connections by Siemens NetPro, max.	8	16		
S7 connections	BSEND, BRCV, GET, PUT, Connection of active and passive data handling	BSEND, BRCV, GET, PUT, Connection of active and passive data handling		
User data per S7 connection, max.	32 KB	32 KB		
TCP-connections	FETCH PASSIV, WRITE PASSIV, Connection of passive data handling	FETCH PASSIV, WRITE PASSIV, Connection of passive data handling		
User data per TCP connection, max.	64 KB	64 KB		
ISO-connections	-	-		
User data per ISO connection, max.	-	-		
ISO on TCP connections (RFC 1006)	FETCH PASSIV, WRITE PASSIV, Connection of passive data handling	FETCH PASSIV, WRITE PASSIV, Connection of passive data handling		
User data per ISO on TCP connection, max.	32 KB	32 KB		
UDP-connections	-	-		
User data per UDP connection, max.	-	-		
UDP-multicast-connections	-	-		
UDP-broadcast-connections	-	-		
Ethernet open communication				
Number of connections, max.	8	24		
User data per ISO on TCP connection, max.	8 KB	8 KB		
User data per native TCP connection, max.	8 KB	8 KB		
User data per ad hoc TCP connection, max.	1460 Byte	1460 Byte		
User data per UDP connection, max.	1472 Byte	1472 Byte		
EtherCAT Master				
Number of EtherCAT-slaves	128	512		
Update time	500 µs .. 512 ms	500 µs .. 512 ms		
Address range inputs, max.	2 KB	4 KB		
Address range outputs, max.	2 KB	4 KB		
EoE support	✓	✓		
FoE support	✓	✓		
Distributed Clock support	✓	✓		
Hotconnect Slaves	✓	✓		
Management & diagnosis				
Protocols	ICMP LLC	ICMP LLC		
Web based diagnosis	-	-		
NCM diagnosis	✓	✓		

CPUs CPUs STEP7 programmable, EtherCAT					
315-4EC12					
317-4EC12					

Order number	315-4EC12	317-4EC12		
Housing				
Material	PPE	PPE		
Mounting	Rail System 300	Rail System 300		
Mechanical data				
Dimensions (WxHxD)	80 mm x 125 mm x 120 mm	80 mm x 125 mm x 120 mm		
Weight	430 g	440 g		
Environmental conditions				
Operating temperature	0 °C to 60 °C	0 °C to 60 °C		
Storage temperature	-25 °C to 70 °C	-25 °C to 70 °C		
Certifications				
UL508 certification	in preparation	in preparation		

Connections, Interfaces

CPUs | CPUs STEP7 programmable, EtherCAT

315-4EC12
317-4EC12

315-4EC12



- + ① + DC 24 V
- ② 0 V



- ① Transmit +
- ② Transmit -
- ③ Receive +
- ④ -
- ⑤ -
- ⑥ Receive -
- ⑦ -
- ⑧ -

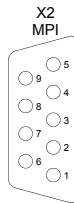

- ① n. c.
- ② M24V
- ③ RxD/TxD-P (line B)
- ④ RTS
- ⑤ M5V
- ⑥ P5V
- ⑦ P24V
- ⑧ RxD/TxD-N (line A)
- ⑨ n.c.

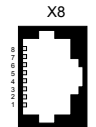

- ① Transmit +
- ② Transmit -
- ③ Receive +
- ④ -
- ⑤ -
- ⑥ Receive -
- ⑦ -
- ⑧ -

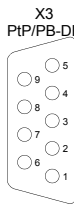

- ① shield
- ② M24V
- ③ RxD/TxD-P (line B)
- ④ RTS
- ⑤ M5V
- ⑥ P5V
- ⑦ P24V
- ⑧ RxD/TxD-N (line A)
- ⑨ n.c.

317-4EC12



- + ① + DC 24 V
- ② 0 V



- ① Transmit +
- ② Transmit -
- ③ Receive +
- ④ -
- ⑤ -
- ⑥ Receive -
- ⑦ -
- ⑧ -

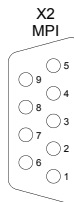

- ① n. c.
- ② M24V
- ③ RxD/TxD-P (line B)
- ④ RTS
- ⑤ M5V
- ⑥ P5V
- ⑦ P24V
- ⑧ RxD/TxD-N (line A)
- ⑨ n.c.

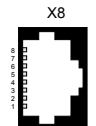

- ① Transmit +
- ② Transmit -
- ③ Receive +
- ④ -
- ⑤ -
- ⑥ Receive -
- ⑦ -
- ⑧ -

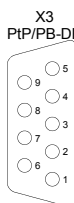

- ① shield
- ② M24V
- ③ RxD/TxD-P (line B)
- ④ RTS
- ⑤ M5V
- ⑥ P5V
- ⑦ P24V
- ⑧ RxD/TxD-N (line A)
- ⑨ n.c.

Power supply



Structure and Function

Power supply modules are used to supply the system as well as the sensors and actuators with direct current. They convert the mains AC voltage into a DC voltage of 24 V.

Power supply modules can be mounted on the mounting surface, together with 300S components using a profile rail.

The power supplies have no connection to the backplane bus.

Characteristics

- › Depending on the model Automatic Wide Range Input detection (AC 100 V - 240 V) or manual switching AC 120/230 V
- › Connection to a single phase AC voltage network
- › Nominal input voltage AC 120/230 V, 50/60 Hz
- › Nominal output voltage DC 24 V
- › Safe electrical isolation according to EN 60 950
- › Can be used as load power supply
- › Front integrated status LEDs for fault diagnosis
- › Protection against short circuit, overload and open circuit
- › IP 20 protection
- › Compact design
- › 24 month warranty

Characteristics SPEED-Bus power supply

- › Power supply for the CPU 317S
- › Automatic start-up with the power of the CPU 317S
- › Output current 5.5 A, total output current max. 10 A
- › Defined power-down in the case of a power supply failure
- › Protection against short circuit and overload
- › Overheat protection
- › 24 month warranty

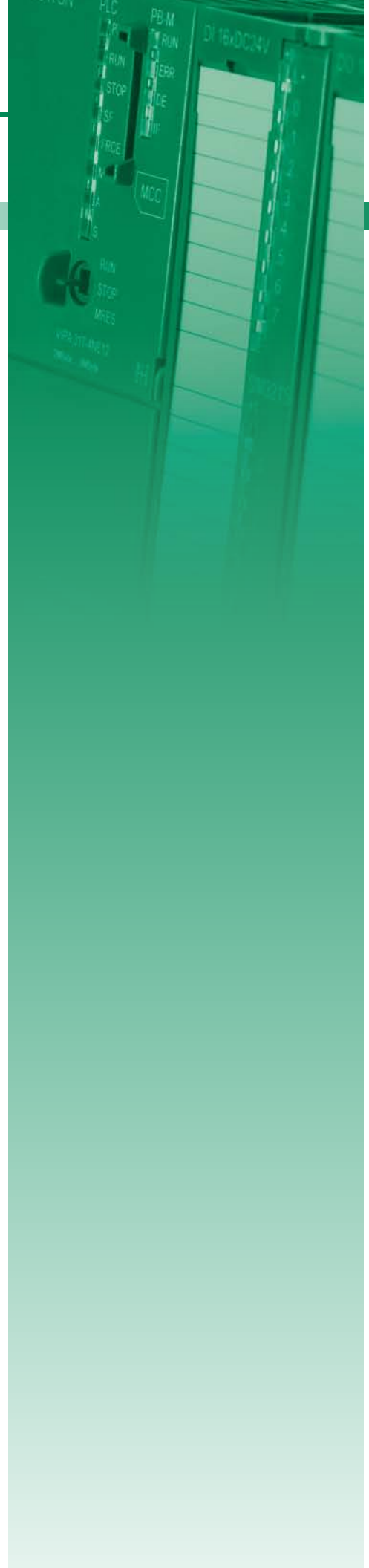

Overview



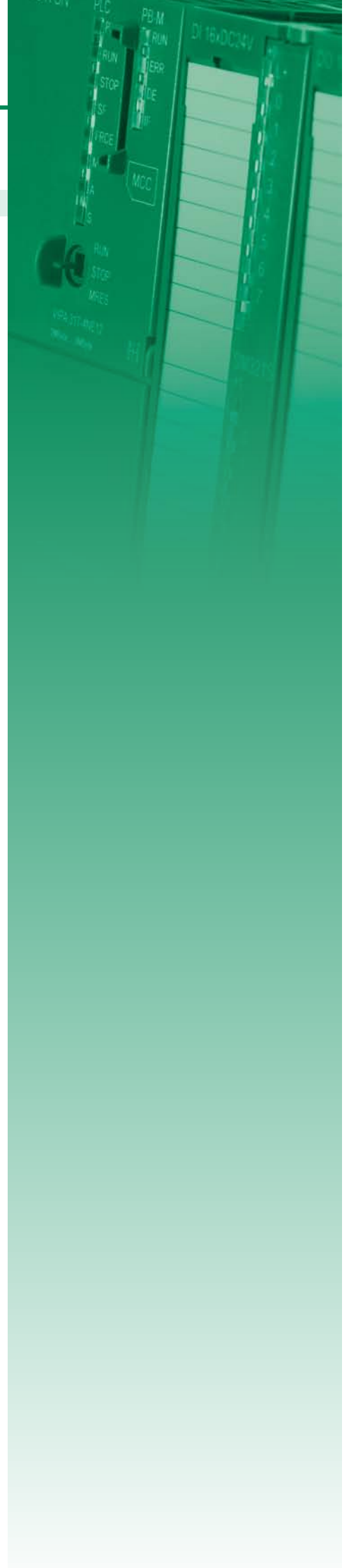

Order no.	Name/Description	Page
Power supply		
307-1BA00	PS 307 - Power supply ▶ Output current 2.5 A ▶ Output voltage DC 24 V ▶ AC 100...240 V without manual switch	480
307-1EA00	PS 307 - Power supply ▶ Output current 5 A ▶ Output voltage DC 24 V ▶ AC 120/230 V, 60/50 Hz switchable	480
307-1FB70	PS 307S - Power supply - SPEED-Bus ▶ Only for CPU 317S ▶ Output current 5.5A	480
307-1KA00	PS 307 - Power supply ▶ Output current 10 A ▶ Output voltage DC 24 V ▶ AC 120/230 V, 60/50 Hz switchable	480



Power supply

Power supply | Power supply

307-1BA00
307-1EA00
307-1FB70
307-1KA00

Order number	307-1BA00	307-1EA00	307-1FB70	307-1KA00
Figure				
Type	PS 307	PS 307	PS 307S - SPEED-Bus	PS 307
General information				
Note	-	-	-	-
Features	<ul style="list-style-type: none"> ▸ Output current 2.5 A ▸ Output voltage DC 24 V ▸ AC 100...240 V without manual switch 	<ul style="list-style-type: none"> ▸ Output current 5 A ▸ Output voltage DC 24 V ▸ AC 120/230 V, 60/50 Hz switchable 	<ul style="list-style-type: none"> ▸ Only for CPU 317S ▸ Output current 5.5A 	<ul style="list-style-type: none"> ▸ Output current 10 A ▸ Output voltage DC 24 V ▸ AC 120/230 V, 60/50 Hz switchable
SPEED-Bus	-	-	-	-
Technical data power supply				
Input voltage (rated value)	AC 100...240 V	AC 120/230 V	DC 24 V	AC 120/230 V
Input voltage (permitted range)	AC 100...240 V	AC 90...132/180...264 V	DC 20.4...28.8 V	AC 90...132/180...264 V
Mains frequency (rated value)	50...60 Hz	50...60 Hz	-	50...60 Hz
Mains frequency (permitted range)	47...63 Hz	47...63 Hz	-	47...63 Hz
Input current (at 120 V)	0.58 A	2.2 A	-	4.1 A
Input current (at 230 V)	0.29 A	1.3 A	-	2.1 A
Inrush current (at 25 °C)	30 A	45 A	5 A	55 A
I _{Δt}	1 A ² s	1.2 A ² s	0.5 A ² s	9 A ² s
Power consumption typ.	67 W	138 W	36 W	275 W
Output voltage (rated value)	24 V	24 V	5.2 V	24 V
Output current (rated value)	2.5 A	5 A	5.5 A	10 A
Power supply parallel switchable	-	-	-	-
Protect type	short circuits, overload, vacancy, over temperature (IP20)	short circuits (electr.) non-latching, overload, vacancy	short circuit (electr.), overload, over temperature (IP20)	short circuits (electr.) non-latching, overload, vacancy
Ripple of output voltage (max.), BW=20 MHz	150 mV	150 mV	150 mV	150 mV
Efficiency typ.	90 %	87 %	90 %	87 %
Power loss typ.	6 W	18 W	6 W	35 W
Status information, alarms, diagnostics				
Status display	yes	yes	yes	yes
Interrupts	no	no	no	no
Process alarm	no	no	no	no
Diagnostic interrupt	no	no	no	no
Diagnostic functions	no	no	no	no
Diagnostics information read-out	none	none	none	none
Supply voltage display	none	none	green LED	none
Group error display	none	none	red LED	none
Channel error display	none	none	none	none

Power supply | Power supply

307-1BA00
307-1EA00
307-1FB70
307-1KA00

Order number	307-1BA00	307-1EA00	307-1FB70	307-1KA00
Housing				
Material	PPE	PPE	PPE / PA 6.6	PPE
Mounting	Rail System 300	Rail System 300	DIN rail SPEED-Bus	Rail System 300
Mechanical data				
Dimensions (WxHxD)	40 mm x 125 mm x 120 mm	80 mm x 125 mm x 120 mm	40 mm x 125 mm x 120 mm	120 mm x 125 mm x 120 mm
Weight	310 g	610 g	210 g	1110 g
Environmental conditions				
Operating temperature	0 °C to 60 °C	0 °C to 60 °C	0 °C to 60 °C	0 °C to 60 °C
Storage temperature	-25 °C to 70 °C	-25 °C to 70 °C	-25 °C to 70 °C	-25 °C to 70 °C
Certifications				
UL508 certification	-	-	-	-

Connections, Interfaces

Power supply | Power supply

307-1BA00
 307-1EA00
 307-1FB70
 307-1KA00

307-1BA00

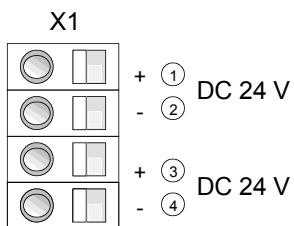
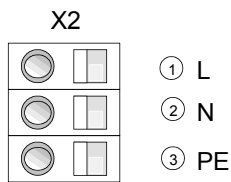

307-1EA00

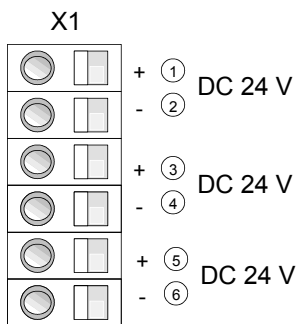
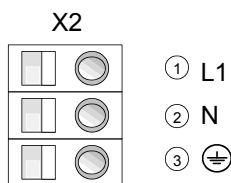

Power supply | Power supply

307-1BA00
 307-1EA00
 307-1FB70
 307-1KA00

307-1FB70

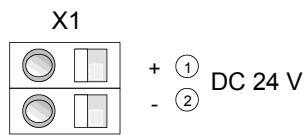

307-1KA00

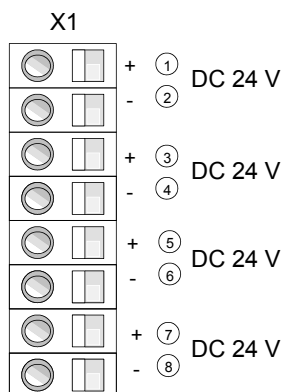
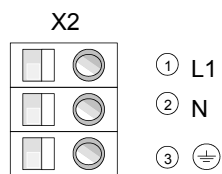

Signal modules digital



Structure and Function

Digital modules for the connection of sensors and actuators are the interface of the PLC to the process. Digital input modules acquire the binary control signals from the process level and transform them into interpretable signals for the control. Digital output modules convert the internal binary control signals into signals suitable for the process level.

Characteristics

- › Large selection. Modules are available for all popular applications
- › High-Speed DI-module for the SPEED-Bus (parameters 2.56 μ s ... 40 ms)
- › High-Speed DO-module for the SPEED-Bus (100 kHz)
- › Compact design
- › LED-status indicator
- › Electrically isolated to the backplane bus
- › Selectable connection method - screw terminals or cage clamps
- › Label strips included and easily visible on the front
- › 24 month warranty

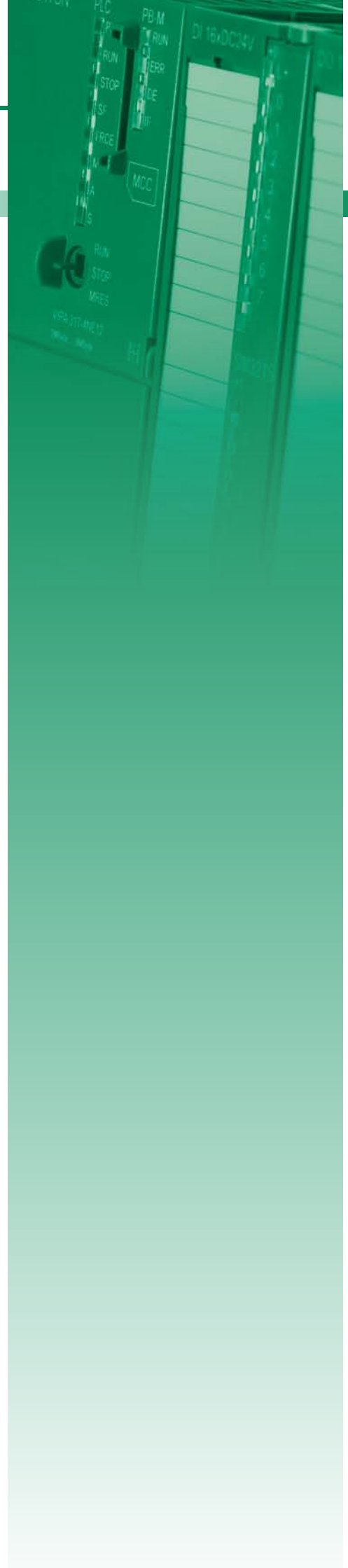



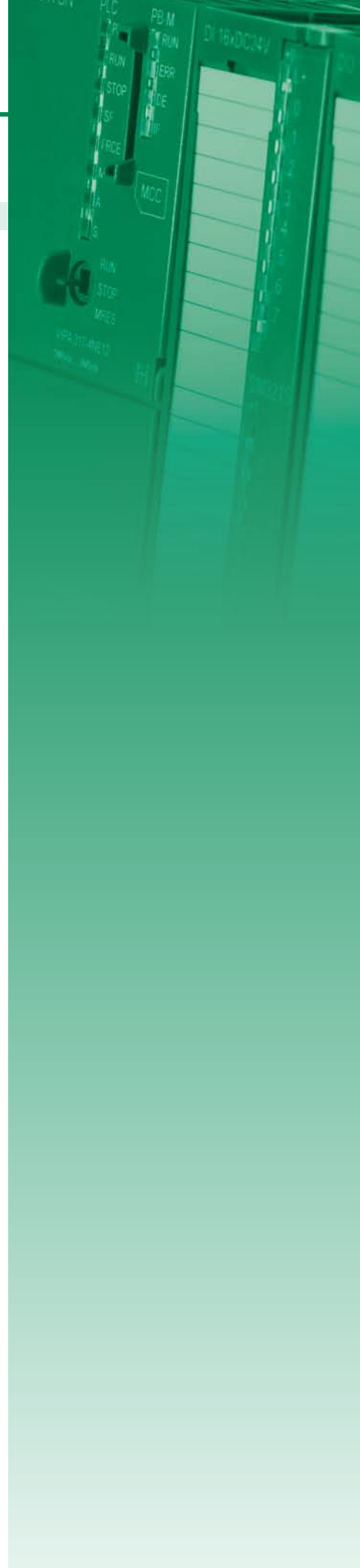

Overview

Order no.	Name/Description	Page
Digital input modules		
321-1BH01	SM 321 - Digital input ‣ 16 inputs	486
321-1BH70	SM 321S - FAST Digital input - SPEED-Bus ‣ SPEED-Bus ‣ 16 fast inputs ‣ Parameterizable as alarm/ETS	486
321-1BL00	SM 321 - Digital input ‣ 32 inputs	486
321-1FH00	SM 321 - Digital input ‣ 16 inputs, in groups of 4 ‣ AC 120/230 V	486
Digital output modules		
322-1BF01	SM 322 - Digital output ‣ 8 outputs, in groups of 4 ‣ Output current 2 A	490
322-1BH01	SM 322 - Digital output ‣ 16 outputs, in groups of 8 ‣ Output current 1 A	490
322-1BH41	SM 322 - Digital output ‣ 16 outputs, in groups of 8 ‣ DC 24 V ‣ Output current 2 A	490
322-1BH60	SM 322 - Digital output ‣ 16 outputs ‣ 1 input (activation for outputs) ‣ 16 switches (automatic, manual 0/1) ‣ Output current 0.5 A	490
322-1BH70	SM 322S - FAST Digital output - SPEED-Bus ‣ SPEED-Bus ‣ 16 fast outputs ‣ Output current 0.5 A	494
322-1BL00	SM 322 - Digital output ‣ 32 outputs, in groups of 8 ‣ DC 24 V ‣ Output current 1 A	494
322-1HH00	SM 322 - Digital output ‣ 16 relay outputs, in groups of 8 ‣ AC 230 V/ DC 30 V ‣ Contact rating per channel 5 A	494
322-5FF00	SM 322 - Digital output ‣ 8 outputs, in groups of 1 ‣ AC 120/230 V ‣ Output current 2 A ‣ Substitute value output (programmable)	494
Digital in/output modules		
323-1BH00	SM 323 - Digital in-/output ‣ 16 channels (as inputs or outputs) ‣ Diagnostic function ‣ Output current 1 A	498
323-1BH01	SM 323 - Digital in-/output ‣ 8 inputs/ 8 outputs ‣ Output current 1 A	498
323-1BH70	SM 323S - FAST Digital in-/output - SPEED-Bus ‣ SPEED-Bus ‣ 16 fast inputs/outputs ‣ Output current 0.5 A	498
323-1BL00	SM 323 - Digital in-/output ‣ 16 inputs/ 16 outputs ‣ Output current 1 A	498



Digital input modules

Signal modules digital Digital input modules						
321-1BH01						
321-1BH70						
321-1BL00						
321-1FH00						

Order number	321-1BH01	321-1BH70	321-1BL00	321-1FH00
Figure				
Type	SM 321	SM 321S - SPEED-Bus	SM 321	SM 321
General information				
Note	-	-	-	-
Features	▷ 16 inputs	▷ SPEED-Bus ▷ 16 fast inputs ▷ Parameterizable as alarm/ETS	▷ 32 inputs	▷ 16 inputs, in groups of 4 ▷ AC 120/230 V
SPEED-Bus	-	✓	-	-
Current consumption/power loss				
Current consumption from backplane bus	25 mA	390 mA	35 mA	35 mA
Power loss	3.5 W	5 W	6.5 W	5 W
Technical data digital inputs				
Number of inputs	16	16	32	16
Cable length, shielded	1000 m	1000 m	1000 m	1000 m
Cable length, unshielded	600 m	600 m	600 m	600 m
Rated load voltage	-	DC 20.4...28.8 V	-	AC 120/230 V
Current consumption from load voltage L+ (without load)	-	15 mA	-	-
Rated value	DC 20.4...28.8 V	DC 24 V	DC 20.4...28.8 V	AC 120/230 V
Input voltage for signal "0"	DC 0...5 V	DC 0...5 V	DC 0...5 V	AC 0...40 V
Input voltage for signal "1"	DC 15...28.8 V	DC 15...28.8 V	DC 15...28.8 V	AC 79...264 V
Input voltage hysteresis	-	-	-	-
Frequency range	-	-	-	47...63 Hz
Input resistance	-	-	-	-
Input current for signal "1"	7 mA	7 mA	7 mA	7 mA
Connection of Two-Wire-BEROs possible	✓	✓	✓	✓
Max. permissible BERO quiescent current	1.5 mA	1.5 mA	1.5 mA	1.5 mA
Input delay of "0" to "1"	3 ms	parameterizable 2.56µs - 40ms	3 ms	25 ms
Input delay of "1" to "0"	3 ms	parameterizable 2.56µs - 40ms	3 ms	25 ms
Number of simultaneously utilizable inputs horizontal configuration	16	16	32	16
Number of simultaneously utilizable inputs vertical configuration	16	16	32	16
Input characteristic curve	IEC 61131-2, type 1	IEC 61131-2, type 1	IEC 61131-2, type 1	-
Initial data size	2 Byte	2 Byte	4 Byte	2 Byte

Signal modules digital | Digital input modules

321-1BH01					
321-1BH70					
321-1BL00					
321-1FH00					

Order number	321-1BH01	321-1BH70	321-1BL00	321-1FH00
Status information, alarms, diagnostics				
Status display	green LED per channel	green LED per channel	green LED per channel	green LED per channel
Interrupts	no	yes	no	no
Process alarm	no	yes, parameterizable	no	no
Diagnostic interrupt	no	yes, parameterizable	no	no
Diagnostic functions	no	yes	no	no
Diagnostics information read-out	none	possible	none	none
Supply voltage display	none	green LED	none	none
Group error display	none	none	none	none
Channel error display	none	none	none	none
Isolation				
Between channels	-	-	-	✓
Between channels of groups to	16	16	16	4
Between channels and backplane bus	✓	✓	✓	✓
Insulation tested with	DC 500 V	DC 500 V	DC 500 V	DC 4000 V
Datasizes				
Input bytes	2	2 / 48	4	2
Output bytes	0	0	0	0
Parameter bytes	0	0 / 66	0	0
Diagnostic bytes	0	16	0	0
Housing				
Material	PPE	PPE	PPE	PPE
Mounting	Rail System 300	DIN rail SPEED-Bus	Rail System 300	Rail System 300
Mechanical data				
Dimensions (WxHxD)	40 mm x 125 mm x 120 mm	40 mm x 125 mm x 120 mm	40 mm x 125 mm x 120 mm	40 mm x 125 mm x 120 mm
Weight	220 g	220 g	240 g	240 g
Environmental conditions				
Operating temperature	0 °C to 60 °C	0 °C to 60 °C	0 °C to 60 °C	0 °C to 60 °C
Storage temperature	-25 °C to 70 °C	-25 °C to 70 °C	-25 °C to 70 °C	-25 °C to 70 °C
Certifications				
UL508 certification	yes	yes	yes	yes

SLIO
100V
200V
300S
500S
HMI
Teleservice
StarterKits
Safety
Solutions
Software
Accessories
Appendix

Connections, Interfaces

Signal modules digital Digital input modules					
321-1BH01					
321-1BH70					
321-1BL00					
321-1FH00					

321-1BH01

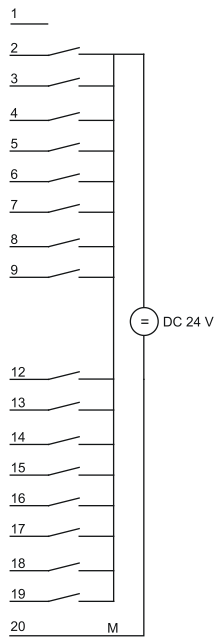

321-1BH70

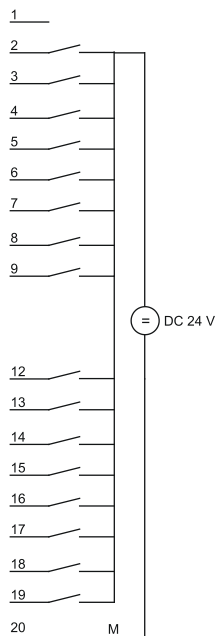

Signal modules digital | Digital input modules

321-1BH01
 321-1BH70
 321-1BL00
 321-1FH00

321-1BL00

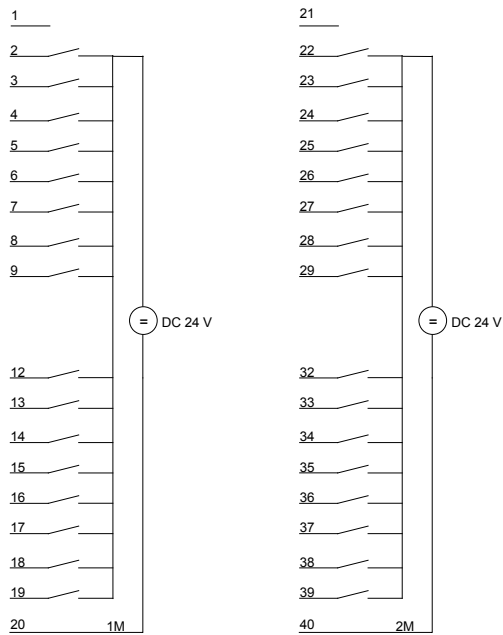



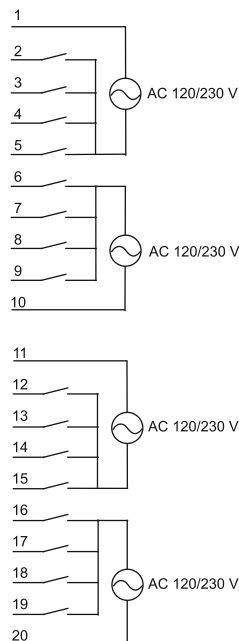

321-1FH00



Digital output modules

Signal modules digital Digital output modules					
322-1BF01	322-1BH70				
322-1BH01	322-1BL00				
322-1BH41	322-1HH00				
322-1BH60	322-5FF00				

Order number	322-1BF01	322-1BH01	322-1BH41	322-1BH60
Figure				
Type	SM 322	SM 322	SM 322	SM 322
General information				
Note	-	-	-	-
Features	<ul style="list-style-type: none"> 8 outputs, in groups of 4 Output current 2 A 	<ul style="list-style-type: none"> 16 outputs, in groups of 8 Output current 1 A 	<ul style="list-style-type: none"> 16 outputs, in groups of 8 DC 24 V Output current 2 A 	<ul style="list-style-type: none"> 16 outputs 1 input (activation for outputs) 16 switches (automatic, manual 0/1) Output current 0.5 A
SPEED-Bus	-	-	-	-
Current consumption/power loss				
Current consumption from backplane bus	65 mA	110 mA	110 mA	100 mA
Power loss	7.5 W	4 W	4 W	6 W
Technical data digital outputs				
Number of outputs	8	16	16	16
Cable length, shielded	1000 m	1000 m	1000 m	1000 m
Cable length, unshielded	600 m	600 m	600 m	600 m
Rated load voltage	DC 24 V	DC 24 V	DC 24 V	DC 24 V
Current consumption from load voltage L+ (without load)	68 mA	30 mA	30 mA	140 mA
Total current per group, horizontal configuration, 40°C	8 A	4 A	8 A	8 A
Total current per group, horizontal configuration, 60°C	8 A	4 A	8 A	8 A
Total current per group, vertical configuration	8 A	4 A	8 A	8 A
Output current at signal "1", rated value	2 A	1 A	2 A	0.5 A
Output delay of "0" to "1"	150 µs	150 µs	150 µs	max. 100 µs
Output delay of "1" to "0"	100 µs	100 µs	100 µs	max. 500 µs
Minimum load current	-	-	-	-
Lamp load	10 W	5 W	10 W	5 W
Parallel switching of outputs for redundant control of a load	possible (only outputs group)	possible (only outputs group)	possible (only outputs group)	not possible
Parallel switching of outputs for increased power	possible (only outputs group)	possible (only outputs group)	possible (only outputs group)	not possible
Actuation of digital input	✓	✓	✓	✓
Switching frequency with resistive load	max. 1000 Hz	max. 1000 Hz	max. 1000 Hz	max. 1000 Hz
Switching frequency with inductive load	max. 0.5 Hz	max. 0.5 Hz	max. 0.5 Hz	max. 0.5 Hz
Switching frequency on lamp load	max. 10 Hz	max. 10 Hz	max. 10 Hz	max. 10 Hz
Internal limitation of inductive shut-off voltage	L+ (-52 V)	L+ (-52 V)	L+ (-52 V)	L+ (-52 V)
Short-circuit protection of output	yes, electronic	yes, electronic	yes, electronic	yes, electronic
Trigger level	3 A	1.5 A	3 A	1 A

Signal modules digital Digital output modules					
322-1BF01	322-1BH70				
322-1BH01	322-1BL00				
322-1BH41	322-1HH00				
322-1BH60	322-5FF00				

Order number	322-1BF01	322-1BH01	322-1BH41	322-1BH60
Number of operating cycle of relay outputs	-	-	-	-
Switching capacity of contacts	-	-	-	-
Output data size	1 Byte	2 Byte	2 Byte	2 Byte
Status information, alarms, diagnostics				
Status display	green LED per channel	green LED per channel	green LED per channel	green LED per channel
Interrupts	no	no	no	no
Process alarm	no	no	no	no
Diagnostic interrupt	no	no	no	no
Diagnostic functions	no	no	no	no
Diagnostics information read-out	none	none	none	none
Supply voltage display	green LED per group	green LED per group	green LED per group	green LED per group
Group error display	red SF LED	red SF LED	red SF LED	red SF LED
Channel error display	none	none	none	none
Isolation				
Between channels	✓	✓	✓	-
Between channels of groups to	4	8	8	16
Between channels and backplane bus	✓	✓	✓	✓
Insulation tested with	DC 500 V	DC 500 V	DC 500 V	DC 500 V
Datasizes				
Input bytes	0	0	0	0
Output bytes	1	2	2	2
Parameter bytes	0	0	0	0
Diagnostic bytes	0	0	0	0
Housing				
Material	PPE	PPE	PPE	PPE
Mounting	Rail System 300	Rail System 300	Rail System 300	Rail System 300
Mechanical data				
Dimensions (WxHxD)	40 mm x 125 mm x 120 mm	40 mm x 125 mm x 120 mm	40 mm x 125 mm x 120 mm	40 mm x 125 mm x 120 mm
Weight	240 g	230 g	230 g	230 g
Environmental conditions				
Operating temperature	0 °C to 60 °C	0 °C to 60 °C	0 °C to 60 °C	0 °C to 60 °C
Storage temperature	-25 °C to 70 °C	-25 °C to 70 °C	-25 °C to 70 °C	-25 °C to 70 °C
Certifications				
UL508 certification	yes	yes	yes	yes

SLIO
100V
200V
300S
500S
HMI
Teleservice
StarterKits
Safety
Solutions
Software
Accessories
Appendix

Connections, Interfaces

Signal modules digital Digital output modules					
322-1BF01	322-1BH70				
322-1BH01	322-1BL00				
322-1BH41	322-1HH00				
322-1BH60	322-5FF00				

322-1BF01

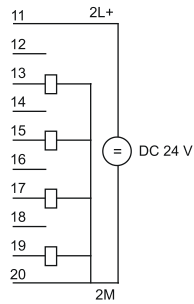
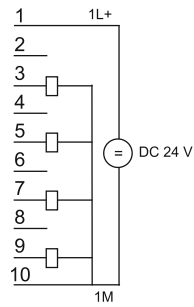

322-1BH01

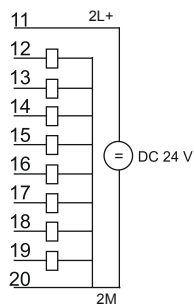
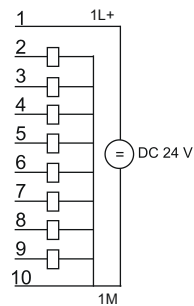

Signal modules digital | Digital output modules

322-1BF01	322-1BH70				
322-1BH01	322-1BL00				
322-1BH41	322-1HH00				
322-1BH60	322-5FF00				

322-1BH41

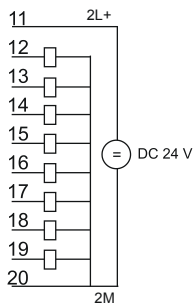
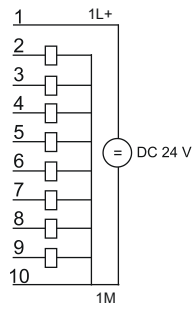

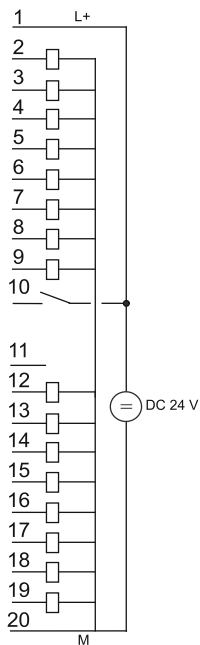

322-1BH60



- SLIO
- 100V
- 200V
- 300S
- 500S
- HMI
- Teleservice
- StarterKits
- Safety
- Solutions
- Software
- Accessories
- Appendix

Digital output modules

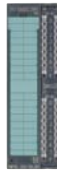
Signal modules digital Digital output modules					
322-1BF01	322-1BH70				
322-1BH01	322-1BL00				
322-1BH41	322-1HH00				
322-1BH60	322-5FF00				

Order number	322-1BH70	322-1BL00	322-1HH00	322-5FF00
Figure				
Type	SM 322S - SPEED-Bus	SM 322	SM 322	SM 322
General information				
Note	-	-	-	-
Features	<ul style="list-style-type: none"> › SPEED-Bus › 16 fast outputs › Output current 0.5 A 	<ul style="list-style-type: none"> › 32 outputs, in groups of 8 › DC 24 V › Output current 1 A 	<ul style="list-style-type: none"> › 16 relay outputs, in groups of 8 › AC 230 V/ DC 30 V › Contact rating per channel 5 A 	<ul style="list-style-type: none"> › 8 outputs, in groups of 1 › AC 120/230 V › Output current 2 A › Substitute value output (programmable)
SPEED-Bus	✓	-	-	-
Current consumption/power loss				
Current consumption from backplane bus	390 mA	200 mA	80 mA	100 mA
Power loss	5 W	6 W	4 W	8.6 W
Technical data digital outputs				
Number of outputs	16	32	16	8
Cable length, shielded	1000 m	1000 m	1000 m	1000 m
Cable length, unshielded	600 m	600 m	600 m	600 m
Rated load voltage	DC 24 V	DC 24 V	DC 30 V/ AC 230 V	AC 120/230 V
Current consumption from load voltage L+ (without load)	30 mA	30 mA	-	2 mA
Total current per group, horizontal configuration, 40°C	4 A	2.5 A	8 A	8 A
Total current per group, horizontal configuration, 60°C	4 A	2.5 A	8 A	4 A
Total current per group, vertical configuration	4 A	2.5 A	8 A	4 A
Output current at signal "1", rated value	0.5 A	1 A	5 A	2 A
Output delay of "0" to "1"	6.12 µs	150 µs	10 ms	-
Output delay of "1" to "0"	6.12 µs	100 µs	5 ms	-
Minimum load current	-	-	-	-
Lamp load	5 W	6 W	6 W	50 W
Parallel switching of outputs for redundant control of a load	not possible	possible (only outputs group)	not possible	possible
Parallel switching of outputs for increased power	not possible	not possible	not possible	not possible
Actuation of digital input	✓	✓	✓	✓
Switching frequency with resistive load	max. 100 kHz	max. 1000 Hz	max. 10 Hz	max. 10 Hz
Switching frequency with inductive load	max. 0.5 Hz	max. 0.5 Hz	max. 0.5 Hz	max. 0.5 Hz
Switching frequency on lamp load	max. 10 Hz	max. 1 Hz	max. 1 Hz	max. 1 Hz
Internal limitation of inductive shut-off voltage	L+ (-52 V)	L+ (-52 V)	-	-
Short-circuit protection of output	yes, electronic	yes, electronic	-	Fuse 3.15 A / 250 V, quick response

Signal modules digital Digital output modules					
322-1BF01	322-1BH70				
322-1BH01	322-1BL00				
322-1BH41	322-1HH00				
322-1BH60	322-5FF00				

Order number	322-1BH70	322-1BL00	322-1HH00	322-5FF00
Trigger level	1 A	1.5 A	-	3.15 A
Number of operating cycle of relay outputs	-	-	-	-
Switching capacity of contacts	-	-	5 A	-
Output data size	2 Byte	4 Byte	2 Byte	1 Byte
Status information, alarms, diagnostics				
Status display	green LED per channel	green LED per channel	green LED per channel	green LED per channel
Interrupts	no	no	no	no
Process alarm	no	no	no	no
Diagnostic interrupt	no	no	no	no
Diagnostic functions	no	no	no	no
Diagnostics information read-out	none	none	none	none
Supply voltage display	green LED per group	green LED per group	none	none
Group error display	red SF LED	red SF LED	none	red SF LED
Channel error display	none	none	none	none
Isolation				
Between channels	✓	✓	✓	✓
Between channels of groups to	8	8	8	1
Between channels and backplane bus	✓	✓	✓	✓
Insulation tested with	DC 500 V	DC 500 V	AC 1500 V	AC 1500 V
Datasizes				
Input bytes	0	0	0	0
Output bytes	2	4	2	1
Parameter bytes	0	0	0	21
Diagnostic bytes	0	0	0	0
Housing				
Material	PPE	PPE	PPE	PPE
Mounting	DIN rail SPEED-Bus	Rail System 300	Rail System 300	Rail System 300
Mechanical data				
Dimensions (WxHxD)	40 mm x 125 mm x 120 mm	40 mm x 125 mm x 120 mm	40 mm x 125 mm x 120 mm	40 mm x 125 mm x 120 mm
Weight	250 g	260 g	290 g	330 g
Environmental conditions				
Operating temperature	0 °C to 60 °C	0 °C to 60 °C	0 °C to 60 °C	0 °C to 60 °C
Storage temperature	-25 °C to 70 °C	-25 °C to 70 °C	-25 °C to 70 °C	-25 °C to 70 °C
Certifications				
UL508 certification	yes	yes	yes	yes

Connections, Interfaces

Signal modules digital | Digital output modules

322-1BF01	322-1BH70				
322-1BH01	322-1BL00				
322-1BH41	322-1HH00				
322-1BH60	322-5FF00				

322-1BH70

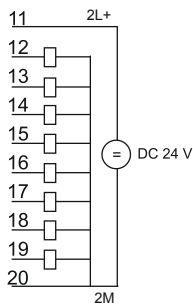
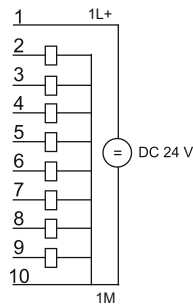

322-1BL00

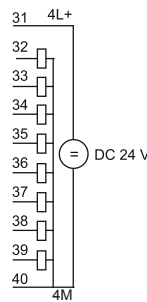
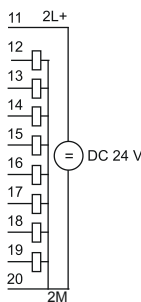
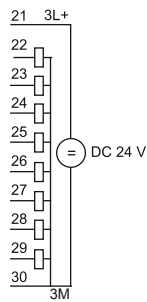
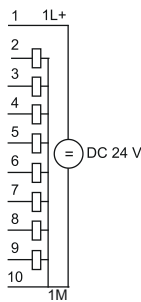

Signal modules digital | Digital output modules

322-1BF01	322-1BH70				
322-1BH01	322-1BL00				
322-1BH41	322-1HH00				
322-1BH60	322-5FF00				

322-1HH00

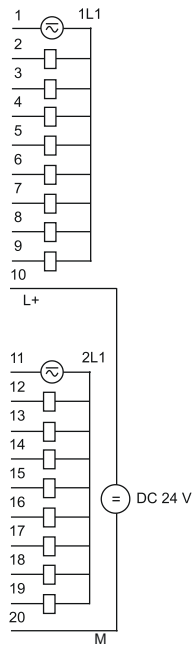



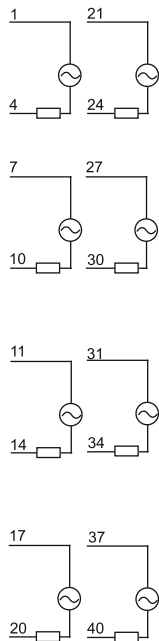

322-5FF00



Digital in/output modules

Signal modules digital Digital in/output modules					
323-1BH00					
323-1BH01					
323-1BH70					
323-1BL00					

Order number	323-1BH00	323-1BH01	323-1BH70	323-1BL00
Figure				
Type	SM 323	SM 323	SM 323S - SPEED-Bus	SM 323
General information				
Note	-	-	-	-
Features	<ul style="list-style-type: none"> ▶ 16 channels (as inputs or outputs) ▶ Diagnostic function ▶ Output current 1 A 	<ul style="list-style-type: none"> ▶ 8 inputs/ 8 outputs ▶ Output current 1 A 	<ul style="list-style-type: none"> ▶ SPEED-Bus ▶ 16 fast inputs/outputs ▶ Output current 0.5 A 	<ul style="list-style-type: none"> ▶ 16 inputs/ 16 outputs ▶ Output current 1 A
SPEED-Bus	-	-	✓	-
Current consumption/power loss				
Current consumption from backplane bus	130 mA	70 mA	390 mA	130 mA
Power loss	4 W	4 W	5 W	5.8 W
Technical data digital inputs				
Number of inputs	16	8	16	16
Cable length, shielded	1000 m	1000 m	1000 m	1000 m
Cable length, unshielded	600 m	600 m	600 m	600 m
Rated load voltage	DC 24 V	DC 24 V	DC 24 V	DC 24 V
Current consumption from load voltage L+ (without load)	30 mA	15 mA	-	30 mA
Rated value	DC 20.4...28.8 V	DC 20.4...28.8 V	DC 20.4...28.8 V	DC 20.4...28.8 V
Input voltage for signal "0"	DC 0...5 V	DC 0...5 V	DC 0...5 V	DC 0...5 V
Input voltage for signal "1"	DC 15...28.8 V	DC 15...28.8 V	DC 15...28.8 V	DC 15...28.8 V
Input voltage hysteresis	-	-	-	-
Frequency range	-	-	-	-
Input resistance	-	-	-	-
Input current for signal "1"	7 mA	7 mA	7 mA	7 mA
Connection of Two-Wire-BERs possible	✓	✓	✓	✓
Max. permissible BERO quiescent current	1.5 mA	1.5 mA	1.5 mA	1.5 mA
Input delay of "0" to "1"	3 ms	3 ms	parameterizable 2.56µs - 40ms	3 ms
Input delay of "1" to "0"	3 ms	3 ms	parameterizable 2.56µs - 40ms	3 ms
Number of simultaneously utilizable inputs horizontal configuration	16	8	16	16
Number of simultaneously utilizable inputs vertical configuration	16	8	16	16
Input characteristic curve	IEC 61131-2, type 1	IEC 61131-2, type 1	IEC 61131-2, type 1	IEC 61131-2, type 1
Initial data size	2 Byte	1 Byte	2 Byte	2 Byte

Signal modules digital | Digital in/output modules

323-1BH00					
323-1BH01					
323-1BH70					
323-1BL00					

Order number	323-1BH00	323-1BH01	323-1BH70	323-1BL00
Technical data digital outputs				
Number of outputs	16	8	16	16
Cable length, shielded	1000 m	1000 m	1000 m	1000 m
Cable length, unshielded	600 m	600 m	600 m	600 m
Rated load voltage	DC 24 V	DC 24 V	DC 24 V	DC 24 V
Reverse polarity protection of rated load voltage	✓	✓	✓	✓
Current consumption from load voltage L+ (without load)	30 mA	15 mA	50 mA	30 mA
Output current at signal "1", rated value	1 A	1 A	0.5 A	1 A
Output delay of "0" to "1"	150 µs	150 µs	6.12 µs	150 µs
Output delay of "1" to "0"	100 µs	100 µs	6.12 µs	100 µs
Minimum load current	-	-	-	-
Lamp load	5 W	5 W	5 W	5 W
Parallel switching of outputs for redundant control of a load	possible (only outputs group)	possible (only outputs group)	not possible	possible (only outputs group)
Parallel switching of outputs for increased power	not possible	not possible	not possible	not possible
Actuation of digital input	✓	✓	✓	✓
Switching frequency with resistive load	max. 1000 Hz	max. 1000 Hz	max. 100 kHz	max. 1000 Hz
Switching frequency with inductive load	max. 0.5 Hz	max. 0.5 Hz	max. 0.5 Hz	max. 0.5 Hz
Switching frequency on lamp load	max. 10 Hz	max. 10 Hz	max. 10 Hz	max. 10 Hz
Internal limitation of inductive shut-off voltage	L+ (-52 V)	L+ (-52 V)	L+ (-52 V)	L+ (-52 V)
Short-circuit protection of output	yes, electronic	yes, electronic	yes, electronic	yes, electronic
Trigger level	1.5 A	1.5 A	1 A	1.5 A
Number of operating cycle of relay outputs	-	-	-	-
Switching capacity of contacts	-	-	-	-
Output data size	2 Byte	1 Byte	2 Byte	2 Byte
Status information, alarms, diagnostics				
Status display	green LED per channel	green LED per channel	green LED per channel	green LED per channel
Interrupts	no	no	no	no
Process alarm	no	no	no	no
Diagnostic interrupt	no	no	no	no
Diagnostic functions	no	no	no	no
Diagnostics information read-out	none	none	none	none
Supply voltage display	green LED per group	green LED per group	green LED per group	green LED per group
Group error display	red SF LED	red SF LED	red SF LED	red SF LED
Channel error display	none	none	none	none
Isolation				
Between channels	✓	✓	✓	✓
Between channels of groups to	8	8	8	8
Between channels and backplane bus	✓	✓	✓	✓
Insulation tested with	DC 500 V	DC 500 V	DC 500 V	DC 500 V

Signal modules digital Digital in/output modules						
323-1BH00						
323-1BH01						
323-1BH70						
323-1BL00						

Order number	323-1BH00	323-1BH01	323-1BH70	323-1BL00
Datasizes				
Input bytes	2	1	2 / 48	2
Output bytes	2	1	2	2
Parameter bytes	0	0	0 / 66	0
Diagnostic bytes	0	0	16	0
Housing				
Material	PPE	PPE	PPE	PPE
Mounting	Rail System 300	Rail System 300	DIN rail SPEED-Bus	Rail System 300
Mechanical data				
Dimensions (WxHxD)	40 mm x 125 mm x 120 mm	40 mm x 125 mm x 120 mm	40 mm x 125 mm x 120 mm	40 mm x 125 mm x 120 mm
Weight	230 g	240 g	240 g	260 g
Environmental conditions				
Operating temperature	0 °C to 60 °C	0 °C to 60 °C	0 °C to 60 °C	0 °C to 60 °C
Storage temperature	-25 °C to 70 °C	-25 °C to 70 °C	-25 °C to 70 °C	-25 °C to 70 °C
Certifications				
UL508 certification	yes	yes	yes	yes

Connections, Interfaces

Signal modules digital | Digital in/output modules

323-1BH00
 323-1BH01
 323-1BH70
 323-1BL00

323-1BH00

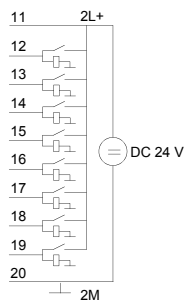
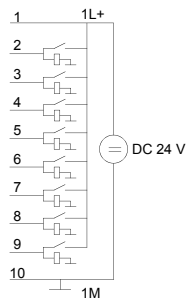

323-1BH01

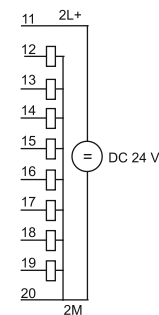
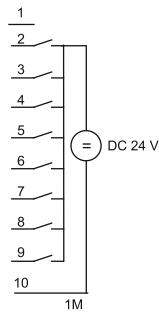

Signal modules digital Digital in/output modules						
323-1BH00						
323-1BH01						
323-1BH70						
323-1BL00						

323-1BH70

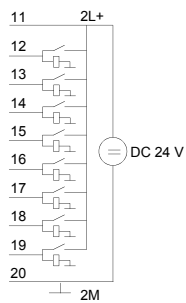
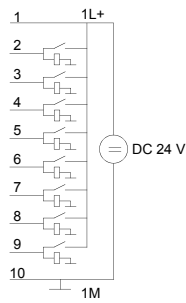

323-1BL00

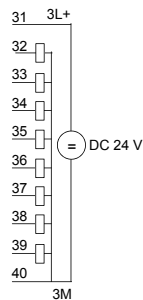
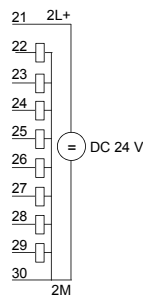
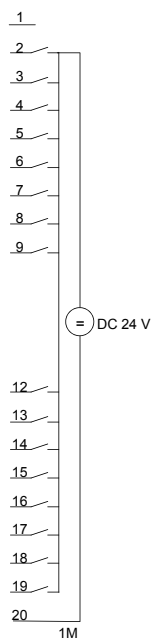

Signal modules analog



Structure and Function

Analog modules for the connection of sensors and actuators are the interface of the PLC to the process. Analog input modules acquire the analog control signals from the process level and transform them into interpretable signals for the control. Analog output modules convert the internal control signals into signals suitable for the process level.

Characteristics

- › Large selection. Modules are available for all popular applications
- › High speed AI-module for the SPEED-Bus (parameterization capable with integrated cache memory)
- › Compact design
- › LED-status indicator
- › Electrically isolated to the backplane bus
- › Selectable connection method - screw terminals or cage clamps
- › Label strips included and easily visible on the front
- › 24 month warranty

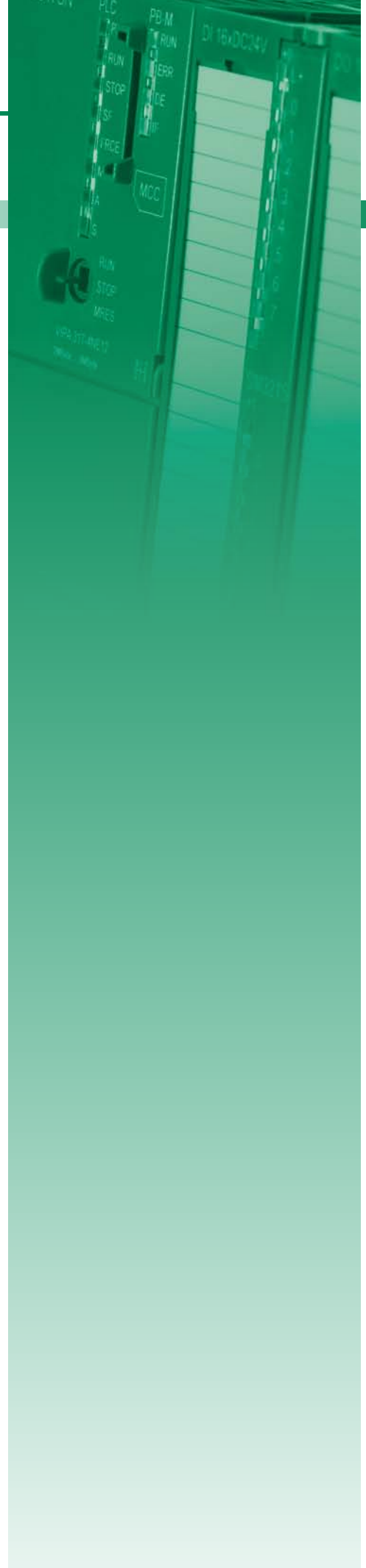



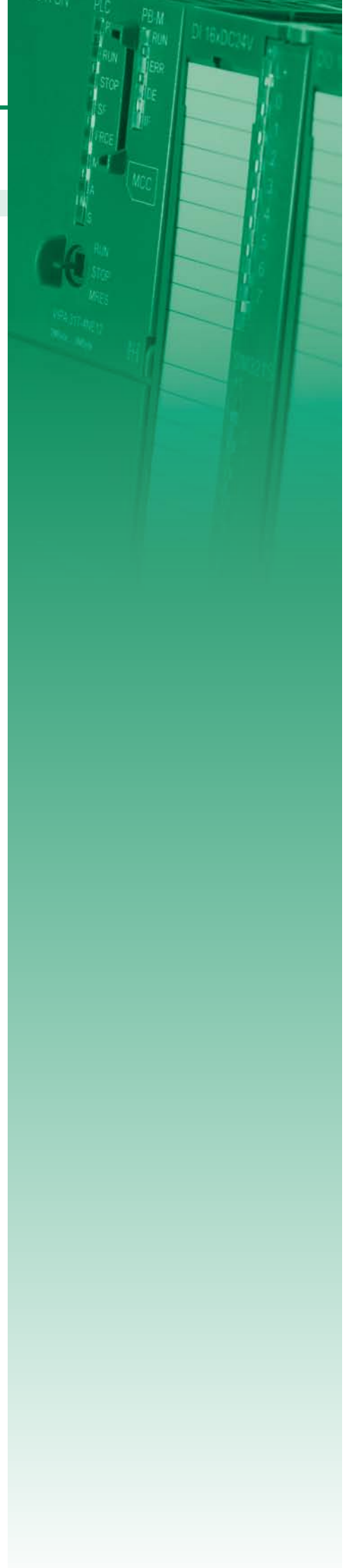

Overview

Order no.	Name/Description	Page
Analog input modules		
331-1KF01	SM 331 - Analog input ▶ 8 inputs 13 bit ▶ Voltage, current ▶ Resistance ▶ Resistance thermometer	506
331-7KF01	SM 331 - Analog input ▶ 8 inputs, in 4 groups ▶ Voltage, current ▶ Resistance ▶ Resistance thermometer ▶ Thermocouples	506
331-7KB01	SM 331 - Analog input ▶ 2 inputs, in 1 group ▶ Voltage, current ▶ Resistance ▶ Resistance thermometer ▶ Thermocouples	506
331-7AF70	SM 331S - Analog input FAST - SPEED-Bus ▶ 8 inputs ▶ Current ± 20 mA ▶ Oscilloscope-/FIFO function ▶ Interrupt parameterizable	506
331-7BF70	SM 331S - Analog input FAST - SPEED-Bus ▶ 8 inputs ▶ Voltage ± 10 V ▶ Oscilloscope-/FIFO-Function ▶ Interrupt parameterizable	512
Analog output modules		
332-5HB01	SM 332 - Analog output ▶ 2 outputs ▶ Configurable ▶ Voltage, current	516
332-5HD01	SM 332 - Analog output ▶ 4 outputs ▶ Configurable ▶ Voltage, current	516
Analog in/output modules		
334-0KE00	SM 334 - Analog in-/output ▶ 4 inputs, 2 outputs ▶ Configurable ▶ Resistance ▶ Voltage 0...10 V	520



Analog input modules

Signal modules analog Analog input modules					
331-1KF01	331-7BF70				
331-7KF01					
331-7KB01					
331-7AF70					

Order number	331-1KF01	331-7KF01	331-7KB01	331-7AF70
Figure				
Type	SM 331	SM 331	SM 331	SM 331S - SPEED-Bus
General information				
Note	-	-	-	-
Features	<ul style="list-style-type: none"> 8 inputs 13 bit Voltage, current Resistance Resistance thermometer 	<ul style="list-style-type: none"> 8 inputs, in 4 groups Voltage, current Resistance Resistance thermometer Thermocouples 	<ul style="list-style-type: none"> 2 inputs, in 1 group Voltage, current Resistance Resistance thermometer Thermocouples 	<ul style="list-style-type: none"> 8 inputs Current ± 20 mA Oscilloscope-/FIFO function Interrupt parameterizable
SPEED-Bus	-	-	-	✓
Current consumption/power loss				
Current consumption from backplane bus	255 mA	95 mA	95 mA	530 mA
Power loss	1.3 W	3 W	3 W	4 W
Technical data analog inputs				
Number of inputs	8	8	2	8
Cable length, shielded	50 m	50 m	50 m	50 m
Rated load voltage	-	DC 24 V	DC 24 V	DC 24 V
Current consumption from load voltage L+ (without load)	-	100 mA	100 mA	62 mA
Voltage inputs	✓	✓	✓	-
Min. input resistance (voltage range)	100 k Ω	100 k Ω	100 k Ω	-
Input voltage ranges	-50 mV ... +50 mV -500 mV ... +500 mV -1 V ... +1 V -5 V ... +5 V 0 V ... +10 V -10 V ... +10 V +1 V ... +5 V	-80 mV ... +80 mV -250 mV ... +250 mV -500 mV ... +500 mV -1 V ... +1 V -2.5 V ... +2.5 V -5 V ... +5 V +1 V ... +5 V -10 V ... +10 V	-80 mV ... +80 mV -250 mV ... +250 mV -500 mV ... +500 mV -1 V ... +1 V -2.5 V ... +2.5 V -5 V ... +5 V +1 V ... +5 V -10 V ... +10 V	-
Operational limit of voltage ranges	+/-0.5% ... +/-0.6%	+/-0.6% ... +/-1.0%	+/-0.6% ... +/-1.0%	-
Operational limit of voltage ranges with SFU	-	-	-	-
Basic error limit voltage ranges	+/-0.3% ... +/-0.4%	+/-0.4% ... +/-0.7%	+/-0.4% ... +/-0.7%	-
Basic error limit voltage ranges with SFU	-	-	-	-
Destruction limit current	-	-	-	-
Current inputs	✓	✓	✓	✓
Max. input resistance (current range)	100 Ω	85 Ω	85 Ω	100 Ω
Input current ranges	-20 mA ... +20 mA 0 mA ... +20 mA +4 mA ... +20 mA	-3.2 mA ... +3.2 mA -10 mA ... +10 mA -20 mA ... +20 mA 0 mA ... +20 mA +4 mA ... +20 mA	-3.2 mA ... +3.2 mA -10 mA ... +10 mA -20 mA ... +20 mA 0 mA ... +20 mA +4 mA ... +20 mA	-20 mA ... +20 mA
Operational limit of current ranges	+/-0.5%	+/-0.7%	+/-0.7%	+/-0.6%
Operational limit of current ranges with SFU	-	-	-	-
Radical error limit current ranges with SFU	+/-0.3%	+/-0.5%	+/-0.5%	+/-0.4%

Signal modules analog Analog input modules					
331-1KF01	331-7BF70				
331-7KF01					
331-7KB01					
331-7AF70					

Order number	331-1KF01	331-7KF01	331-7KB01	331-7AF70
Radical error limit current ranges with SFU	-	-	-	-
Destruction limit current inputs (electrical current)	-	-	-	-
Destruction limit current inputs (voltage)	-	-	-	-
Resistance inputs	✓	✓	✓	-
Resistance ranges	0 ... 600 Ohm 0 ... 6000 Ohm	0 ... 150 Ohm 0 ... 300 Ohm 0 ... 600 Ohm	0 ... 150 Ohm 0 ... 300 Ohm 0 ... 600 Ohm	-
Operational limit of resistor ranges	+/-0.5%	+/-0.7%	+/-0.7%	-
Operational limit of resistor ranges with SFU	-	-	-	-
Basic error limit	+/-0.3%	+/-0.5%	+/-0.5%	-
Basic error limit with SFU	-	-	-	-
Destruction limit resistance inputs	-	-	-	-
Resistance thermometer inputs	✓	✓	✓	-
Resistance thermometer ranges	Pt100 Ni100 Ni1000	Pt100 Ni100	Pt100 Ni100	-
Operational limit of resistance thermometer ranges	+/-1K ... +/-1.2K	+/-0.7% ... +/-0.8%	+/-0.7% ... +/-0.8%	-
Operational limit of resistance thermometer ranges with SFU	-	-	-	-
Basic error limit thermoresistor ranges	+/-0.8K	+/-0.5% ... +/-0.6%	+/-0.5% ... +/-0.6%	-
Basic error limit thermoresistor ranges with SFU	-	-	-	-
Destruction limit resistance thermometer inputs	-	-	-	-
Thermocouple inputs	-	✓	✓	-
Thermocouple ranges	-	type J type R type K type N type L type E type T type S type B type C	type J type R type K type N type L type E type T type S type B type C	-
Operational limit of thermocouple ranges	-	+/-1.3% ... +/-2.0%	+/-1.3% ... +/-2.0%	-
Operational limit of thermocouple ranges with SFU	-	-	-	-
Basic error limit thermoelement ranges	-	+/-0.7% ... +/-1.0%	+/-0.7% ... +/-1.0%	-
Basic error limit thermoelement ranges with SFU	-	-	-	-
Destruction limit thermocouple inputs	-	-	-	-
Programmable temperature compensation	-	✓	✓	-
External temperature compensation	-	✓	✓	-
Internal temperature compensation	-	✓	✓	-
Internal temperature compensation	-	3 K	3 K	-
Technical unit of temperature measurement	-	-	-	-
Resolution in bit	13	14	14	16

SLIO
100V
200V
300S
500S
HMI
Teleservice
StarterKits
Safety
Solutions
Software
Accessories
Appendix

Signal modules analog Analog input modules					
331-1KF01	331-7BF70				
331-7KF01					
331-7KB01					
331-7AF70					

Order number	331-1KF01	331-7KF01	331-7KB01	331-7AF70
Measurement principle	Sigma-Delta	Sigma-Delta	Sigma-Delta	successive approximation
Basic conversion time	61 ms/51 ms / channel	4 ms/18 ms/22 ms/68 ms / channel	4 ms/18 ms/22 ms/68 ms / channel	25 µs all channels
Noise suppression for frequency	50 Hz/60 Hz	1300 Hz/190 Hz/150 Hz/50 Hz + 60 Hz	1300 Hz/190 Hz/150 Hz/50 Hz + 60 Hz	-
Initial data size	16 Byte	16 Byte	4 Byte	16 Byte
Status information, alarms, diagnostics				
Status display	none	none	none	none
Interrupts	no	yes	yes	yes
Process alarm	no	yes, parameterizable	yes, parameterizable	yes, parameterizable
Diagnostic interrupt	no	yes, parameterizable	yes, parameterizable	yes, parameterizable
Diagnostic functions	no	yes	yes	yes
Diagnostics information read-out	none	possible	possible	possible
Supply voltage display	none	none	none	none
Group error display	none	red SF LED	red SF LED	red SF LED
Channel error display	none	red LED per channel	red LED per channel	none
Isolation				
Between channels	-	-	-	✓
Between channels of groups to	-	-	-	1
Between channels and backplane bus	✓	✓	✓	✓
Between channels and power supply	-	✓	✓	✓
Max. potential difference between circuits	-	-	-	-
Max. potential difference between inputs (Ucm)	DC 2 V	DC 3 V	DC 3 V	DC 30 V
Max. potential difference between Mana and Mintern (Uiso)	-	DC 75 V/ AC 60 V	DC 75 V/ AC 60 V	-
Max. potential difference between inputs and Mana (Ucm)	-	DC 3 V	DC 3 V	-
Max. potential difference between inputs and Mintern (Uiso)	DC 75 V/ AC 60 V	-	-	DC 75 V/ AC 60 V
Max. potential difference between Mintern and outputs	-	-	-	-
Insulation tested with	DC 500 V	DC 500 V	DC 500 V	DC 500 V
Datasizes				
Input bytes	16	16	4	16
Output bytes	0	0	0	0
Parameter bytes	21	21	21	41
Diagnostic bytes	0	16	16	16

Signal modules analog | Analog input modules

331-1KF01 331-7KF01 331-7KB01 331-7AF70	331-7BF70					
--	-----------	--	--	--	--	--

Order number	331-1KF01	331-7KF01	331-7KB01	331-7AF70
Housing				
Material	PPE	PPE	PPE	PPE
Mounting	Rail System 300	Rail System 300	Rail System 300	DIN rail SPEED-Bus
Mechanical data				
Dimensions (WxHxD)	40 mm x 125 mm x 120 mm	40 mm x 125 mm x 120 mm	40 mm x 125 mm x 120 mm	40 mm x 125 mm x 120 mm
Weight	260 g	240 g	220 g	235 g
Environmental conditions				
Operating temperature	0 °C to 60 °C	0 °C to 60 °C	0 °C to 60 °C	0 °C to 60 °C
Storage temperature	-25 °C to 70 °C	-25 °C to 70 °C	-25 °C to 70 °C	-25 °C to 70 °C
Certifications				
UL508 certification	yes	yes	yes	yes

Connections, Interfaces

Signal modules analog Analog input modules					
331-1KF01	331-7BF70				
331-7KF01					
331-7KB01					
331-7AF70					

331-1KF01



1	U+	21	U+
2	I+	22	I+
CH 0	3 S-	CH 4	23 S-
4	M+	24	M+
5	M-	25	M-
6	U+	26	U+
7	I+	27	I+
CH 1	8 S-	CH 5	28 S-
9	M+	29	M+
10	M-	30	M-
11	U+	31	U+
12	I+	32	I+
CH 2	13 S-	CH 6	33 S-
14	M+	34	M+
15	M-	35	M-
16	U+	36	U+
17	I+	37	I+
CH 3	18 S-	CH 7	38 S-
19	M+	39	M+
20	M-	40	M-

331-7KF01

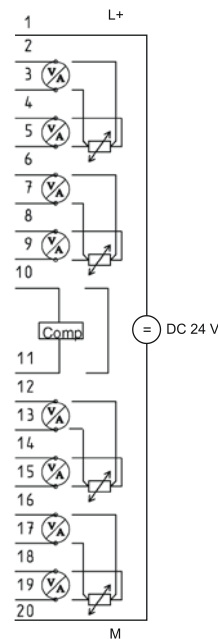

Signal modules analog | Analog input modules

331-1KF01 331-7KF01 331-7KB01 331-7AF70	331-7BF70					
--	-----------	--	--	--	--	--

331-7KB01

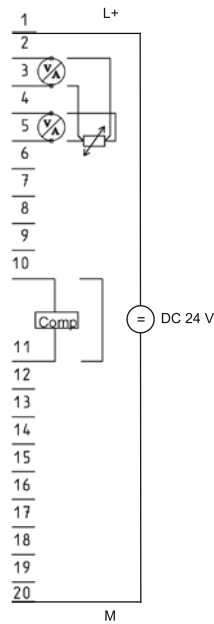

331-7AF70

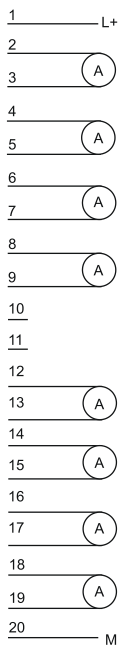

Analog input modules

Signal modules analog Analog input modules					
331-1KF01	331-7BF70				
331-7KF01					
331-7KB01					
331-7AF70					

Order number	331-7BF70			
Figure				
Type	SM 331S - SPEED-Bus			
General information				
Note	-			
Features	<ul style="list-style-type: none"> ▶ 8 inputs ▶ Voltage ±10 V ▶ Oscilloscope-/FIFO-Function ▶ Interrupt paramete-rizable 			
SPEED-Bus	✓			
Current consumption/power loss				
Current consumption from backplane bus	530 mA			
Power loss	4 W			
Technical data analog inputs				
Number of inputs	8			
Cable length, shielded	50 m			
Rated load voltage	DC 24 V			
Current consumption from load voltage L+ (without load)	62 mA			
Voltage inputs	✓			
Min. input resistance (voltage range)	120 kΩ			
Input voltage ranges	-10 V ... +10 V			
Operational limit of voltage ranges	+/-0.6%			
Operational limit of voltage ranges with SFU	-			
Basic error limit voltage ranges	+/-0.4%			
Basic error limit voltage ranges with SFU	-			
Destruction limit current	-			
Current inputs	-			
Max. input resistance (current range)	-			
Input current ranges	-			
Operational limit of current ranges	-			
Operational limit of current ranges with SFU	-			
Radical error limit current ranges with SFU	-			
Radical error limit current ranges with SFU	-			
Destruction limit current inputs (electrical current)	-			
Destruction limit current inputs (voltage)	-			
Resistance inputs	-			
Resistance ranges	-			
Operational limit of resistor ranges	-			

Signal modules analog Analog input modules					
331-1KF01	331-7BF70				
331-7KF01					
331-7KB01					
331-7AF70					

Order number	331-7BF70			
Operational limit of resistor ranges with SFU	-			
Basic error limit	-			
Basic error limit with SFU	-			
Destruction limit resistance inputs	-			
Resistance thermometer inputs	-			
Resistance thermometer ranges	-			
Operational limit of resistance thermometer ranges	-			
Operational limit of resistance thermometer ranges with SFU	-			
Basic error limit thermoresistor ranges	-			
Basic error limit thermoresistor ranges with SFU	-			
Destruction limit resistance thermometer inputs	-			
Thermocouple inputs	-			
Thermocouple ranges	-			
Operational limit of thermocouple ranges	-			
Operational limit of thermocouple ranges with SFU	-			
Basic error limit thermoelement ranges	-			
Basic error limit thermoelement ranges with SFU	-			
Destruction limit thermocouple inputs	-			
Programmable temperature compensation	-			
External temperature compensation	-			
Internal temperature compensation	-			
Internal temperature compensation	-			
Technical unit of temperature measurement	-			
Resolution in bit	16			
Measurement principle	successive approximation			
Basic conversion time	25 µs all channels			
Noise suppression for frequency	-			
Initial data size	16 Byte			
Status information, alarms, diagnostics				
Status display	none			
Interrupts	yes			
Process alarm	yes, parameterizable			
Diagnostic interrupt	yes, parameterizable			
Diagnostic functions	yes			
Diagnostics information read-out	possible			
Supply voltage display	none			
Group error display	red SF LED			
Channel error display	none			

SLIO
100V
200V
300S
500S
HMI
Teleservice
StarterKits
Safety
Solutions
Software
Accessories
Appendix

Signal modules analog Analog input modules					
331-1KF01	331-7BF70				
331-7KF01					
331-7KB01					
331-7AF70					

Order number	331-7BF70			
Isolation				
Between channels	✓			
Between channels of groups to	1			
Between channels and backplane bus	✓			
Between channels and power supply	✓			
Max. potential difference between circuits	-			
Max. potential difference between inputs (Ucm)	DC 30 V			
Max. potential difference between Mana and Mintern (Uiso)	-			
Max. potential difference between inputs and Mana (Ucm)	-			
Max. potential difference between inputs and Mintern (Uiso)	DC 75 V/ AC 60 V			
Max. potential difference between Mintern and outputs	-			
Insulation tested with	DC 500 V			
Datasizes				
Input bytes	16			
Output bytes	0			
Parameter bytes	41			
Diagnostic bytes	16			
Housing				
Material	PPE			
Mounting	DIN rail SPEED-Bus			
Mechanical data				
Dimensions (WxHxD)	40 mm x 125 mm x 120 mm			
Weight	235 g			
Environmental conditions				
Operating temperature	0 °C to 60 °C			
Storage temperature	-25 °C to 70 °C			
Certifications				
UL508 certification	yes			

Connections, Interfaces

Signal modules analog | Analog input modules

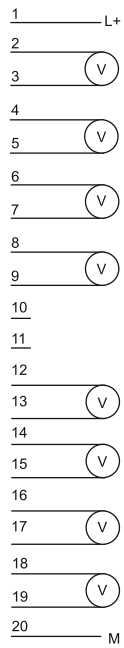

331-1KF01 331-7KF01 331-7KB01 331-7AF70	331-7BF70					
--	-----------	--	--	--	--	--

331-7BF70



Analog output modules

Signal modules analog Analog output modules					
332-5HB01					
332-5HD01					

Order number	332-5HB01	332-5HD01		
Figure				
Type	SM 332	SM 332		
General information				
Note	-	-		
Features	<ul style="list-style-type: none"> ▸ 2 outputs ▸ Configurable ▸ Voltage, current 	<ul style="list-style-type: none"> ▸ 4 outputs ▸ Configurable ▸ Voltage, current 		
SPEED-Bus	-	-		
Current consumption/power loss				
Current consumption from backplane bus	100 mA	125 mA		
Power loss	2.5 W	3.5 W		
Technical data analog outputs				
Number of outputs	2	4		
Cable length, shielded	-	-		
Rated load voltage	DC 24 V	DC 24 V		
Reverse polarity protection of rated load voltage	-	-		
Current consumption from load voltage L+ (without load)	70 mA	115 mA		
Voltage output short-circuit protection	✓	✓		
Voltage outputs	✓	✓		
Min. load resistance (voltage range)	1 kΩ	1 kΩ		
Max. capacitive load (current range)	1 μF	1 μF		
Max. inductive load (current range)	30 mA	30 mA		
Output voltage ranges	-10 V ... +10 V 0 V ... +10 V +1 V ... +5 V	-10 V ... +10 V 0 V ... +10 V +1 V ... +5 V		
Operational limit of voltage ranges	+/-0.2% ... +/-0.8%	+/-0.2% ... +/-0.8%		
Basic error limit voltage ranges	+/-0.1% ... +/-0.5%	+/-0.1% ... +/-0.5%		
Destruction limit against external applied voltage	-	-		
Current outputs	✓	✓		
Max. in load resistance (current range)	500 Ω	500 Ω		
Max. inductive load (current range)	10 mH	10 mH		
Max. inductive load (current range)	-	-		
Output current ranges	-20 mA ... +20 mA 0 mA ... +20 mA +4 mA ... +20 mA	-20 mA ... +20 mA 0 mA ... +20 mA +4 mA ... +20 mA		
Operational limit of current ranges	+/-0.3% ... +/-0.8%	+/-0.3% ... +/-0.8%		
Basic error limit current ranges	+/-0.2% ... +/-0.5%	+/-0.2% ... +/-0.5%		

Signal modules analog Analog output modules					
332-5HB01					
332-5HD01					

Order number	332-5HB01	332-5HD01		
Destruction limit against external applied voltage	-	-		
Settling time for ohmic load	0.2 ms	0.2 ms		
Settling time for capacitive load	1 ms	1 ms		
Settling time for inductive load	1 ms	1 ms		
Resolution in bit	13	13		
Conversion time	0.5 ms all channels	1 ms all channels		
Substitute value can be applied	yes	yes		
Output data size	4 Byte	8 Byte		
Status information, alarms, diagnostics				
Status display	green LED per channel	green LED per channel		
Interrupts	yes	yes		
Process alarm	no	no		
Diagnostic interrupt	yes, parameterizable	yes, parameterizable		
Diagnostic functions	yes	yes		
Diagnostics information read-out	possible	possible		
Supply voltage display	none	none		
Group error display	red SF LED	red SF LED		
Channel error display	red LED per channel	red LED per channel		
Isolation				
Between channels	-	-		
Between channels of groups to	-	-		
Between channels and backplane bus	✓	✓		
Between channels and power supply	✓	✓		
Max. potential difference between circuits	-	-		
Max. potential difference between inputs (Ucm)	-	-		
Max. potential difference between Mana and Mintern (Uiso)	DC 75 V/ AC 60 V	DC 75 V/ AC 60 V		
Max. potential difference between inputs and Mana (Ucm)	-	-		
Max. potential difference between inputs and Mintern (Uiso)	-	-		
Max. potential difference between Mintern and outputs	-	-		
Insulation tested with	DC 500 V	DC 500 V		
Datasizes				
Input bytes	0	0		
Output bytes	4	8		
Parameter bytes	21	21		
Diagnostic bytes	16	16		

Signal modules analog Analog output modules					
332-5HB01					
332-5HD01					

Order number	332-5HB01	332-5HD01		
Housing				
Material	PPE	PPE		
Mounting	Rail System 300	Rail System 300		
Mechanical data				
Dimensions (WxHxD)	40 mm x 125 mm x 120 mm	40 mm x 125 mm x 120 mm		
Weight	230 g	230 g		
Environmental conditions				
Operating temperature	0 °C to 60 °C	0 °C to 60 °C		
Storage temperature	-25 °C to 70 °C	-25 °C to 70 °C		
Certifications				
UL508 certification	yes	yes		

Connections, Interfaces

Signal modules analog | Analog output modules

332-5HB01
332-5HD01

332-5HB01

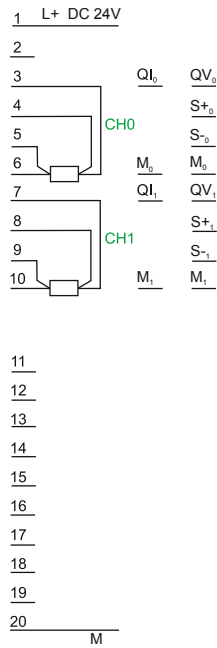

332-5HD01

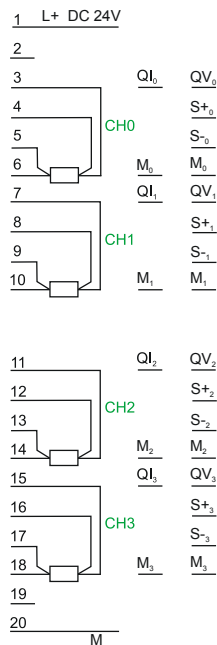

Analog in/output modules

Signal modules analog Analog in/output modules					
334-0KE00					

Order number	334-0KE00			
Figure				
Type	SM 334			
General information				
Note	-			
Features	<ul style="list-style-type: none"> ▸ 4 inputs, 2 outputs ▸ Configurable ▸ Resistance ▸ Voltage 0...10 V 			
SPEED-Bus	-			
Current consumption/power loss				
Current consumption from backplane bus	95 mA			
Power loss	2 W			
Technical data analog inputs				
Number of inputs	4			
Cable length, shielded	100 m			
Rated load voltage	DC 24 V			
Reverse polarity protection of rated load voltage	-			
Current consumption from load voltage L+ (without load)	40 mA			
Voltage inputs	✓			
Min. input resistance (voltage range)	100 kΩ			
Input voltage ranges	0 V ... +10 V			
Operational limit of voltage ranges	+/-0.7%			
Operational limit of voltage ranges with SFU	-			
Basic error limit voltage ranges	+/-0.5%			
Basic error limit voltage ranges with SFU	-			
Destruction limit current	-			
Current inputs	-			
Max. input resistance (current range)	-			
Input current ranges	-			
Operational limit of current ranges	-			
Operational limit of current ranges with SFU	-			
Basic error limit current ranges	-			
Radical error limit current ranges with SFU	-			
Destruction limit current inputs (electrical current)	-			
Destruction limit current inputs (voltage)	-			
Resistance inputs	✓			
Resistance ranges	10000 Ohm			
Operational limit of resistor ranges	+/-3.5%			

Signal modules analog Analog in/output modules					
334-0KE00					

Order number	334-0KE00			
Operational limit of resistor ranges with SFU	-			
Basic error limit	+/-2.8%			
Basic error limit with SFU	-			
Destruction limit resistance inputs	-			
Resistance thermometer inputs	✓			
Resistance thermometer ranges	Pt100			
Operational limit of resistance thermometer ranges	+/-0.1%			
Operational limit of resistance thermometer ranges with SFU	-			
Basic error limit thermoresistor ranges	+/-0.8%			
Basic error limit thermoresistor ranges with SFU	-			
Destruction limit resistance thermometer inputs	-			
Thermocouple inputs	-			
Thermocouple ranges	-			
Operational limit of thermocouple ranges	-			
Operational limit of thermocouple ranges with SFU	-			
Basic error limit thermoelement ranges	-			
Basic error limit thermoelement ranges with SFU	-			
Destruction limit thermocouple inputs	-			
Programmable temperature compensation	-			
External temperature compensation	-			
Internal temperature compensation	-			
Technical unit of temperature measurement	-			
Resolution in bit	12			
Measurement principle	Sigma-Delta			
Basic conversion time	350 ms			
Noise suppression for frequency	50 Hz/60 Hz			
Initial data size	8 Byte			
Technical data analog outputs				
Number of outputs	2			
Cable length, shielded	100 m			
Rated load voltage	DC 24 V			
Reverse polarity protection of rated load voltage	✓			
Current consumption from load voltage L+ (without load)	40 mA			
Voltage output short-circuit protection	✓			
Voltage outputs	✓			
Min. load resistance (voltage range)	1 kΩ			
Max. capacitive load (current range)	1 μF			

SLIO
100V
200V
300S
500S
HMI
Teleservice
StarterKits
Safety
Solutions
Software
Accessories
Appendix

Signal modules analog Analog in/output modules					
334-0KE00					

Order number	334-0KE00			
Max. inductive load (current range)	25 mA			
Output voltage ranges	0 V ... +10 V			
Operational limit of voltage ranges	+/-1%			
Basic error limit voltage ranges	+/-0.8%			
Destruction limit against external applied voltage	-			
Current outputs	-			
Max. in load resistance (current range)	-			
Max. inductive load (current range)	-			
Max. inductive load (current range)	-			
Output current ranges	-			
Operational limit of current ranges	-			
Basic error limit current ranges	-			
Destruction limit against external applied voltage	-			
Settling time for ohmic load	0.8 ms			
Settling time for capacitive load	0.8 ms			
Settling time for inductive load	0.3 ms			
Resolution in bit	12			
Conversion time	0.5 ms per channel			
Substitute value can be applied	-			
Output data size	4 Byte			
Status information, alarms, diagnostics				
Status display	none			
Interrupts	no			
Process alarm	no			
Diagnostic interrupt	no			
Diagnostic functions	no			
Diagnostics information read-out	none			
Supply voltage display	none			
Group error display	none			
Channel error display	none			
Isolation				
Between channels	-			
Between channels of groups to	-			
Between channels and backplane bus	✓			
Between channels and power supply	✓			
Max. potential difference between circuits	-			
Max. potential difference between inputs (Ucm)	DC 1 V			
Max. potential difference between Mana and Mintern (Uiso)	DC 75 V/ AC 60 V			
Max. potential difference between inputs and Mana (Ucm)	DC 1 V			
Max. potential difference between inputs and Mintern (Uiso)	-			

Signal modules analog Analog in/output modules						
334-0KE00						

Order number	334-0KE00			
Max. potential difference between Mintern and outputs	-			
Insulation tested with	DC 500 V			
Datasizes				
Input bytes	8			
Output bytes	4			
Parameter bytes	21			
Diagnostic bytes	0			
Housing				
Material	PPE			
Mounting	Rail System 300			
Mechanical data				
Dimensions (WxHxD)	40 mm x 125 mm x 120 mm			
Weight	210 g			
Environmental conditions				
Operating temperature	0 °C to 60 °C			
Storage temperature	-25 °C to 70 °C			
Certifications				
UL508 certification	yes			

Connections, Interfaces

Signal modules analog Analog in/output modules					
334-0KE00					

334-0KE00



1 L+ DC 24V
 2 IC+₀₁
 3 M+₀
 4 M-₀
 5 M+₁
 6 M-₁
 7 IC-₀₁ M_{ANA}
 8 IC+₂₃
 9 M+₂
 10
 11 M-₂
 12 M+₃
 13 M-₃
 14 M-₃
 15 M_{ANA}
 16 QV₀
 17 M_{ANA}
 18 QV₁
 19 M_{ANA}
 20 M

CH0
 CH1
 CH2
 CH3
 CH0
 CH1

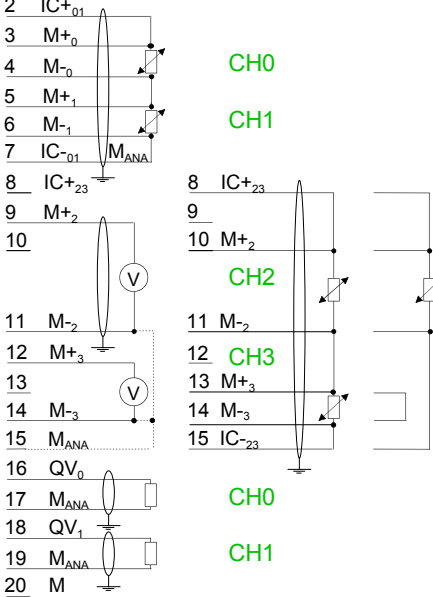

Communication processors



Structure and Function

Communication processors for the connection of different target and source systems, such as via Ethernet to higher-level MES and ERP systems or serially to underlying scanners, printers and other peripherals.

Characteristics

- ▶ High performance
- ▶ Simple parameterization
- ▶ Support for common protocols
- ▶ Compact design
- ▶ LED-status indicator
- ▶ Electrically isolated to the backplane bus
- ▶ 24 month warranty



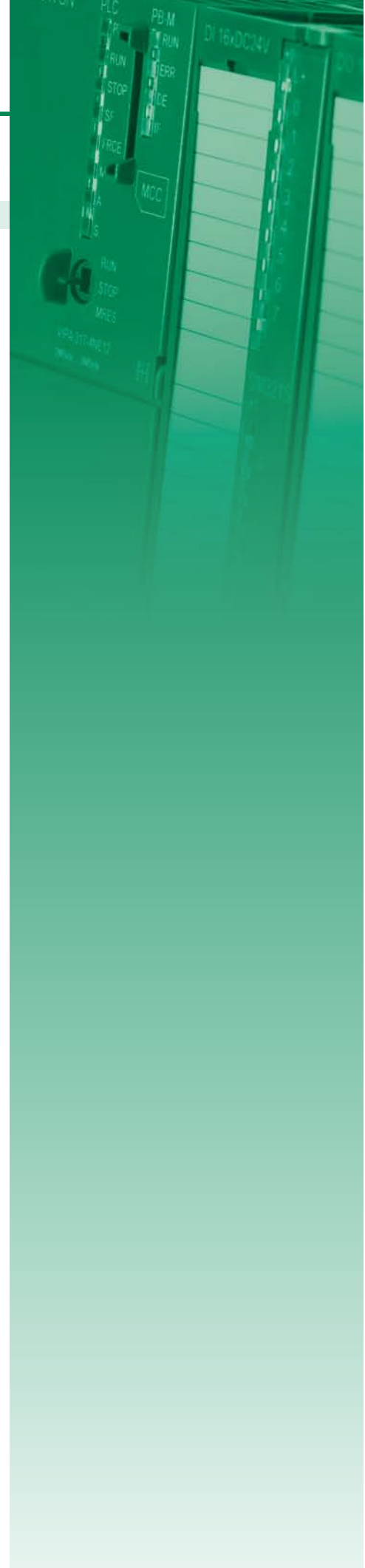

Overview

Order no.	Name/Description	Page
RS232/422/485 and other CPs		
341-1AH01	CP 341 - Communication processor ▶ RS232, isolated ▶ Function compatibility to Siemens CP 341 ▶ Parameterization via the Siemens parameterization package ▶ Data transfer rate up to 76.8 kbit/s ▶ Power supply via backplane bus	528
341-1CH01	CP 341 - Communication processor ▶ RS422/485, isolated ▶ Function compatibility to Siemens CP 341 ▶ Parameterization via the Siemens parameterization package ▶ Data transfer rate up to 76.8 kbit/s ▶ Power supply via backplane bus	528
341-2CH71	CP 341S - Communication processor - SPEED-Bus ▶ 2x RS422/485, isolated ▶ SPEED-Bus ▶ Data transfer rate up to 115.2 kbit/s ▶ Integrated diagnostics buffer	528
Fieldbus master modules		
342-1CA70	CP 342S CAN - CANopen master - SPEED-Bus ▶ CANopen master, SPEED-Bus ▶ 125 CAN slaves connectable ▶ 40 Transmit PDOs, 40 Receive PDOs ▶ 1 SDO (Server), 127 SDO (Client) ▶ Project engineering: VIPA WinCoCT	532
342-1DA70	CP 342S DP - PROFIBUS-DP master - SPEED-Bus ▶ PROFIBUS-DP master (Class 1), SPEED-Bus ▶ RS485 ▶ 124 DP slaves connectable ▶ Project engineering: Siemens SIMATIC Manager ▶ Diagnostic facilities	532
342-1IA70	CP 342S IBS - INTERBUS master - SPEED-Bus ▶ INTERBUS master, SPEED-Bus ▶ RS422 ▶ Diagnostics via LEDs, RS232, Mini-DIN, Dual Port Master ▶ Up to 512 slaves connectable	532
342-2IA71	CP 342S IBS - INTERBUS master - SPEED-Bus ▶ Dual INTERBUS master, SPEED-Bus ▶ 2x RS422 ▶ Diagnostics via LEDs, diagnostics device (2x RJ45), Dual Port Master ▶ Up to 512 slaves connectable	532
Actor/sensor interfaces		
343-2AH10	CP 343-2P ASI - AS-i master ▶ Up to 62 slaves connectable ▶ Corresponding to AS-i specification 3.0 (master profile M3) ▶ Support of analog slaves concerning profile 7.3 resp. 7.4 ▶ Automatic address programming possible (address 0)	536
Ethernet-CPs		
343-1EX71	CP 343S TCP/IP - Ethernet-CP 343 - SPEED-Bus ▶ Ethernet CP 343S-NET, SPEED-Bus ▶ RJ45 ▶ 16 connections via Siemens NetPro ▶ 64 connections via user program ▶ 32 PG/OP connections	539



RS232/422/485 and other CPs

Communication processors RS232/422/485 and other CPs					
341-1AH01					
341-1CH01					
341-2CH71					

Order number	341-1AH01	341-1CH01	341-2CH71	
Figure				
Type	CP 341	CP 341	CP 341	
General information				
Note	-	-	-	
Features	<ul style="list-style-type: none"> ▸ RS232, isolated ▸ Function compatibility to Siemens CP 341 ▸ Parameterization via the Siemens parameterization package ▸ Data transfer rate up to 76.8 kbit/s ▸ Power supply via backplane bus 	<ul style="list-style-type: none"> ▸ RS422/485, isolated ▸ Function compatibility to Siemens CP 341 ▸ Parameterization via the Siemens parameterization package ▸ Data transfer rate up to 76.8 kbit/s ▸ Power supply via backplane bus 	<ul style="list-style-type: none"> ▸ 2x RS422/485, isolated ▸ SPEED-Bus ▸ Data transfer rate up to 115.2 kbit/s ▸ Integrated diagnostics buffer 	
SPEED-Bus	-	-	✓	
Current consumption/power loss				
Current consumption from backplane bus	160 mA	160 mA	750 mA	
Power loss	0.8 W	0.8 W	3.75 W	
Status information, alarms, diagnostics				
Status display	yes	yes	yes	
Interrupts	no	no	no	
Process alarm	no	no	no	
Diagnostic interrupt	yes, parameterizable	yes, parameterizable	no	
Diagnostic functions	no	no	yes, parameterizable	
Diagnostics information read-out	possible	possible	possible	
Supply voltage display	yes	yes	none	
Group error display	red SF LED	red SF LED	yes	
Channel error display	none	none	red LED per channel	
Functionality Sub-D interfaces				
Type	X2	X2	X2	
Type of interface	RS232	RS422/485	RS422/485	
Connector	Sub-D, 9-pin, male	Sub-D, 9-pin, female	Sub-D, 9-pin, female	
Electrically isolated	✓	✓	✓	
MPI	-	-	-	
MP ² (MPI/RS232)	-	-	-	
Point-to-point interface	✓	✓	✓	
Type	-	-	X3	
Type of interface	-	-	RS422/485	
Connector	-	-	Sub-D, 9-pin, female	
Electrically isolated	-	-	✓	
MPI	-	-	-	
MP ² (MPI/RS232)	-	-	-	
Point-to-point interface	-	-	✓	

SLIO
100V
200V
300S
500S
HMI
Teleservice
StarterKits
Safety
Solutions
Software
Accessories
Appendix

Communication processors | RS232/422/485 and other CPs

341-1AH01
341-1CH01
341-2CH71

Order number	341-1AH01	341-1CH01	341-2CH71	
Point-to-point communication				
PtP communication	✓	✓	✓	
Interface isolated	✓	✓	✓	
RS232 interface	✓	-	-	
RS422 interface	-	✓	✓	
RS485 interface	-	✓	✓	
Connector	Sub-D, 9-pin, male	Sub-D, 9-pin, female	Sub-D, 9-pin, female	
Transmission speed, min.	-	150 bit/s	150 bit/s	
Transmission speed, max.	76.8 kbit/s	76.8 kbit/s	115.2 kbit/s	
Cable length, max.	15 m	1200 m	1200 m	
Point-to-point protocol				
ASCII protocol	✓	✓	✓	
STX/ETX protocol	✓	✓	✓	
3964(R) protocol	✓	✓	-	
RK512 protocol	-	-	-	
USS master protocol	-	-	-	
Modbus master protocol	✓	✓	-	
Modbus slave protocol	✓	✓	-	
Special protocols	-	-	-	
Datasizes				
Input bytes	16	16	32	
Output bytes	16	16	32	
Parameter bytes	(16 + 106)	(16 + 106)	75	
Diagnostic bytes	4	4	0	
Housing				
Material	PPE	PPE	PPE	
Mounting	Rail System 300	Rail System 300	DIN rail SPEED-Bus	
Mechanical data				
Dimensions (WxHxD)	40 mm x 125 mm x 120 mm	40 mm x 125 mm x 120 mm	40 mm x 125 mm x 120 mm	
Weight	170 g	170 g	185 g	
Environmental conditions				
Operating temperature	0 °C to 60 °C	0 °C to 60 °C	0 °C to 60 °C	
Storage temperature	-25 °C to 70 °C	-25 °C to 70 °C	-25 °C to 70 °C	
Certifications				
UL508 certification	yes	yes	yes	

Connections, Interfaces

Communication processors RS232/422/485 and other CPs					
341-1AH01					
341-1CH01					
341-2CH71					

341-1AH01

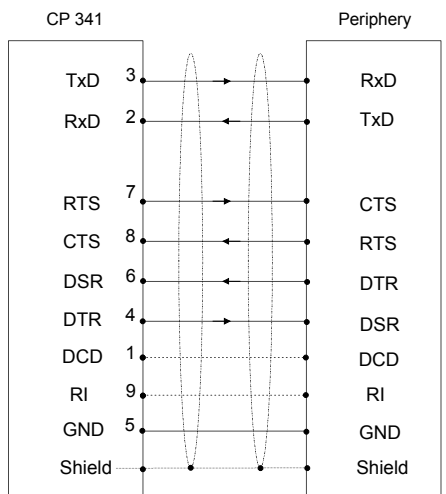
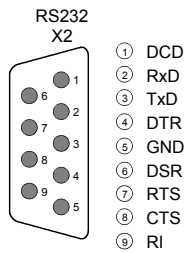

341-1CH01

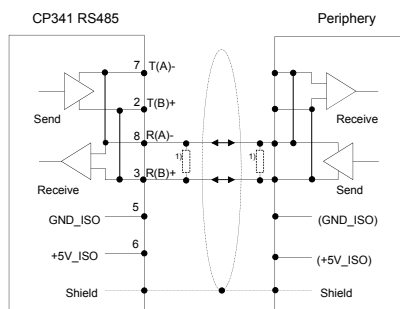
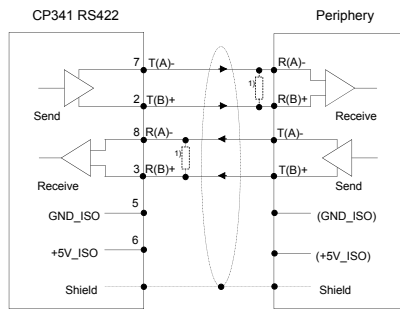
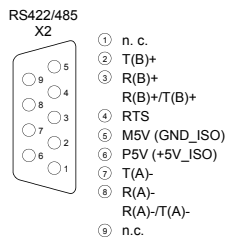

Communication processors | RS232/422/485 and other CPs

341-1AH01
341-1CH01
341-2CH71

341-2CH71



RS422/485 X2

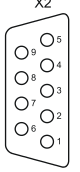

- ① n.c.
- ② T(B)+
- ③ R(B)+/T(B)+
- ④ RTS
- ⑤ M5V (GND_ISO)
- ⑥ P5V (+5V_ISO)
- ⑦ T(A)-
- ⑧ R(A)-
- ⑨ R(A)-/T(A)-
- ⓪ n.c.

CP341 - RS422

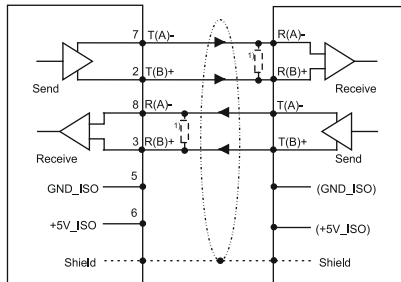

Periphery

RS422/485 X3

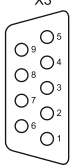

- ① n.c.
- ② T(B)+
- ③ R(B)+/T(B)+
- ④ RTS
- ⑤ M5V (GND_ISO)
- ⑥ P5V (+5V_ISO)
- ⑦ T(A)-
- ⑧ R(A)-
- ⑨ R(A)-/T(A)-
- ⓪ n.c.



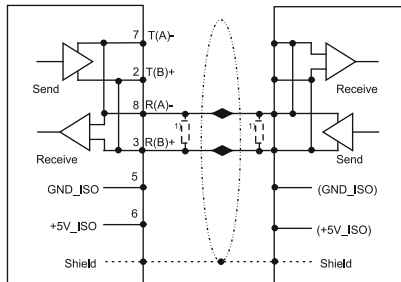

CP341 - RS485



Periphery

Fieldbus master modules

Communication processors Fieldbus master modules						
342-1CA70						
342-1DA70						
342-1IA70						
342-2IA71						

Order number	342-1CA70	342-1DA70	342-1IA70	342-2IA71
Figure				
Type	CP 342S CAN, CANopen master SPEED-Bus	CP 342S DP, PROFIBUS-DP master SPEED-Bus	CP 342S IBS, INTERBUS master SPEED-Bus	CP 342S IBS, dual INTERBUS master SPEED-Bus
General information				
Note	-	-	-	-
Features	<ul style="list-style-type: none"> ▸ CANopen master, SPEED-Bus ▸ 125 CAN slaves connectable ▸ 40 Transmit PDOs, 40 Receive PDOs ▸ 1 SDO (Server), 127 SDO (Client) ▸ Project engineering: VIPA WinCoCT 	<ul style="list-style-type: none"> ▸ PROFIBUS-DP master (Class 1), SPEED-Bus ▸ RS485 ▸ 124 DP slaves connectable ▸ Project engineering: Siemens SIMATIC Manager ▸ Diagnostic facilities 	<ul style="list-style-type: none"> ▸ INTERBUS master, SPEED-Bus ▸ RS422 ▸ Diagnostics via LEDs, RS232, Mini-DIN, Dual Port Master ▸ Up to 512 slaves connectable 	<ul style="list-style-type: none"> ▸ Dual INTERBUS master, SPEED-Bus ▸ 2x RS422 ▸ Diagnostics via LEDs, diagnostics device (2x RJ45), Dual Port Master ▸ Up to 512 slaves connectable
SPEED-Bus	✓	✓	✓	✓
Current consumption/power loss				
Current consumption from backplane bus	550 mA	560 mA	600 mA	1 A
Power loss	2.75 W	2.8 W	3 W	4.5 W
Status information, alarms, diagnostics				
Status display	yes	yes	yes	yes
Interrupts	no	no	no	no
Process alarm	no	no	no	no
Diagnostic interrupt	no	no	no	no
Diagnostic functions	no	no	no	no
Diagnostics information read-out	possible	possible	none	none
Supply voltage display	none	none	green LED	yes
Group error display	yes	yes	yes	yes
Channel error display	none	none	none	none
Functionality Sub-D interfaces				
Type	CAN	DP	IBS	X2
Type of interface	CAN	RS485	RS422	RS422
Connector	Sub-D, 9-pin, male	Sub-D, 9-pin, female	Sub-D, 9-pin, female	Sub-D, 9-pin, female
Electrically isolated	✓	✓	✓	✓
MPI	-	-	-	-
MP ² I (MPI/RS232)	-	-	-	-
Point-to-point interface	-	-	-	-

Communication processors | Fieldbus master modules

342-1CA70					
342-1DA70					
342-1IA70					
342-2IA71					

Order number	342-1CA70	342-1DA70	342-1IA70	342-2IA71
Type	-	-	DIAG 1	X3
Type of interface	-	-	RS232	RS422
Connector	-	-	Sub-D, 9-pin, male	Sub-D, 9-pin, female
Electrically isolated	-	-	✓	✓
MPI	-	-	-	-
MP ² I (MPI/RS232)	-	-	-	-
Point-to-point interface	-	-	✓	-
Functionality RJ45 interfaces				
Type	-	-	-	DIAG 1
Type of interface	-	-	-	-
Connector	-	-	-	RJ45
Electrically isolated	-	-	-	-
PG/OP channel	-	-	-	-
Number of connections, max.	-	-	-	-
Productive connections	-	-	-	-
Type	-	-	-	DIAG 2
Type of interface	-	-	-	-
Connector	-	-	-	RJ45
Electrically isolated	-	-	-	-
PG/OP channel	-	-	-	-
Number of connections, max.	-	-	-	-
Productive connections	-	-	-	-
Housing				
Material	PPE	PPE	PPE	PPE
Mounting	DIN rail SPEED-Bus	DIN rail SPEED-Bus	DIN rail SPEED-Bus	DIN rail SPEED-Bus
Mechanical data				
Dimensions (WxHxD)	40 mm x 125 mm x 120 mm	40 mm x 125 mm x 120 mm	40 mm x 125 mm x 120 mm	40 mm x 125 mm x 120 mm
Weight	210 g	210 g	260 g	260 g
Environmental conditions				
Operating temperature	0 °C to 60 °C	0 °C to 60 °C	0 °C to 60 °C	0 °C to 60 °C
Storage temperature	-25 °C to 70 °C	-25 °C to 70 °C	-25 °C to 70 °C	-25 °C to 70 °C
Certifications				
UL508 certification	yes	yes	yes	-

Connections, Interfaces

Communication processors Fieldbus master modules						
342-1CA70						
342-1DA70						
342-1IA70						
342-2IA71						

342-1CA70



CANopen master X2

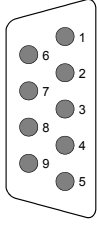

- ① n. c.
- ② CAN low
- ③ CAN Ground
- ④ n. c.
- ⑤ shield
- ⑥ optional Ground
- ⑦ CAN high
- ⑧ n. c.
- ⑨ n. c.

master

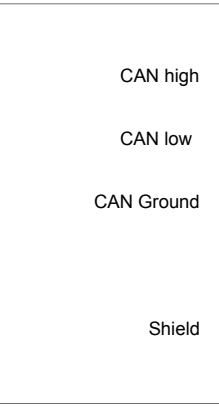

slave

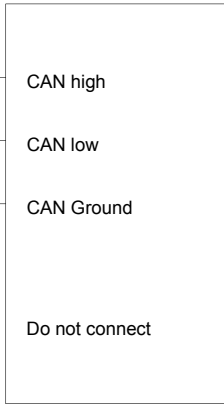

342-1DA70



DP master X2

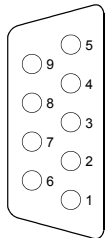

- ① shield
- ② n. c.
- ③ RxD/TxD-P (line B)
- ④ RTS
- ⑤ M5V
- ⑥ P5V
- ⑦ n. c.
- ⑧ RxD/TxD-N (line A)
- ⑨ n.c.

CP 342

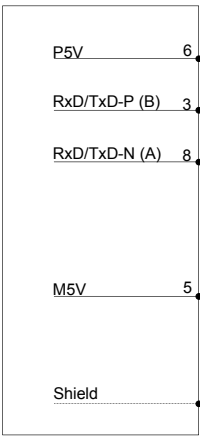

Periphery

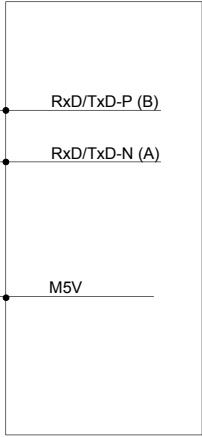

Communication processors | Fieldbus master modules

342-1CA70
342-1DA70
342-1IA70
342-2IA71

342-1IA70



Interbus
RS422
X2

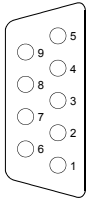

- ① DOH
- ② DIH
- ③ GND-ISO
- ④ GND
- ⑤ +5V
- ⑥ DOL
- ⑦ DIL
- ⑧ +5V
- ⑨ reserved

RS232
diagnostics
X3

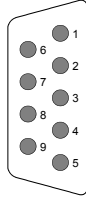

- ① reserved
- ② TxD
- ③ RxD
- ④ reserved
- ⑤ GND
- ⑥ reserved
- ⑦ RTS
- ⑧ CTS
- ⑨ reserved

Mini-DIN slot
diagnostics
X4



342-2IA71



IBS1/IBS2
RS422
X2/X3

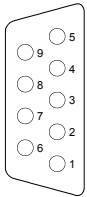

- ① DOH
- ② DIH
- ③ GND (ISO)
- ④ GND
- ⑤ +5V (ISO)
- ⑥ DOL
- ⑦ DIL
- ⑧ +5V
- ⑨ reserved

2x RJ45
Diagnostic device
VIPA-342-0IA01



- ① GND
- ② PCS3
- ③ MISO
- ④ MOSI
- ⑤ SCK
- ⑥ PCS2
- ⑦ VCC
- ⑧ n. c.

Actor/sensor interfaces

Communication processors Actor/sensor interfaces						
343-2AH10						

Order number	343-2AH10			
Figure				
Type	CP 343-2P ASI, AS-i master			
General information				
Note	-			
Features	<ul style="list-style-type: none"> › Up to 62 slaves connectable › Corresponding to AS-i specification 3.0 (master profile M3) › Support of analog slaves concerning profile 7.3 resp. 7.4 › Automatic address programming possible (address 0) 			
SPEED-Bus	-			
Current consumption/power loss				
Current consumption from backplane bus	200 mA			
Power loss	2.5 W			
Status information, alarms, diagnostics				
Status display	yes			
Interrupts	yes			
Process alarm	-			
Diagnostic interrupt	yes			
Diagnostic functions	yes			
Diagnostics information read-out	possible			
Supply voltage display	yes			
Group error display	red SF LED			
Channel error display	none			
Functionality interfaces				
Type of interface	AS-Interface			
Connector	20-pin front connector			
Electrically isolated	-			

Communication processors Actor/sensor interfaces						
343-2AH10						





Order number	343-2AH10			
Housing				
Material	PPE			
Mounting	Rail System 300			
Mechanical data				
Dimensions (WxHxD)	40 mm x 125 mm x 120 mm			
Weight	250 g			
Environmental conditions				
Operating temperature	0 °C to 60 °C			
Storage temperature	-25 °C to 70 °C			
Certifications				
UL508 certification	yes			

Connections, Interfaces

Communication processors Actor/sensor interfaces						
343-2AH10						

343-2AH10



1 _____
 2 _____
 3 _____
 4 _____
 5 _____
 6 _____
 7 _____
 8 _____
 9 _____
 10 _____
 11 _____
 12 _____
 13 _____
 14 _____
 15 _____
 16 _____
 17 +  AS-i + (brown)
 18 -  AS-i - (blue)
 19 +  AS-i + (brown)
 20 -  AS-i - (blue)

Ethernet-CPs

Communication processors Ethernet-CPs						
343-1EX71						

Order number	343-1EX71			
Figure				
Type	CP 343S TCP/IP, Ethernet-CP 343 SPEED-Bus			
General information				
Note	-			
Features	<ul style="list-style-type: none"> ▶ Ethernet CP 343S-NET, SPEED-Bus ▶ RJ45 ▶ 16 connections via Siemens NetPro ▶ 64 connections via user program ▶ 32 PG/OP connections 			
SPEED-Bus	✓			
Current consumption/power loss				
Current consumption from backplane bus	550 mA			
Power loss	2.75 W			
Status information, alarms, diagnostics				
Status display	yes			
Interrupts	no			
Process alarm	no			
Diagnostic interrupt	no			
Diagnostic functions	no			
Diagnostics information read-out	possible			
Supply voltage display	green LED			
Group error display	red SF LED			
Channel error display	none			
Ethernet communication CP				
Number of productive connections, max.	64			
Number of productive connections by Siemens NetPro, max.	16			
S7 connections	USEND, URCV, BSEND, BRCV, GET, PUT, Connection of active and passive data handling			
User data per S7 connection, max.	32 KB			
TCP-connections	SEND, RECEIVE, FETCH PASSIV, WRITE PASSIV, Connection of active and passive data handling			
User data per TCP connection, max.	64 KB			

Communication processors Ethernet-CPs						
343-1EX71						

Order number	343-1EX71			
ISO-connections	SEND, RECEIVE, FETCH PASSIV, WRITE PASSIV, Connection of active and passive data handling			
User data per ISO connection, max.	8 KB			
ISO on TCP connections (RFC 1006)	SEND, RECEIVE, FETCH PASSIV, WRITE PASSIV, Connection of active and passive data handling			
User data per ISO on TCP connection, max.	32 KB			
UDP-connections	SEND and RECEIVE			
User data per UDP connection, max.	2 KB			
UDP-multicast-connections	SEND and RECEIVE (max. 16 Multicast groups)			
UDP-broadcast-connections	SEND			
Functionality RJ45 interfaces				
Type	X1			
Type of interface	Ethernet 10/100 MBit			
Connector	RJ45			
Electrically isolated	✓			
PG/OP channel	✓			
Number of connections, max.	32			
Productive connections	✓			
Housing				
Material	PPE			
Mounting	DIN rail SPEED-Bus			
Mechanical data				
Dimensions (WxHxD)	40 mm x 125 mm x 120 mm			
Weight	210 g			
Environmental conditions				
Operating temperature	0 °C to 60 °C			
Storage temperature	-25 °C to 70 °C			
Certifications				
UL508 certification	yes			

Connections, Interfaces

Communication processors | Ethernet-CPs

343-1EX71						
-----------	--	--	--	--	--	--

343-1EX71



RJ45
X1

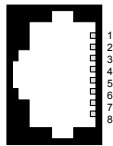

- ① Transmit +
- ② Transmit -
- ③ Receive +
- ④ -
- ⑤ -
- ⑥ Receive -
- ⑦ -
- ⑧ -

Interface modules



Structure and Function

Fieldbus slave modules for the expansion of decentralized control systems with up to 99 fieldbus slave modules, plus I/O modules.

Characteristics

- › For the leading PROFIBUS-DP fieldbus system
- › Cross manufacturer deployable
- › Cross manufacturer mixed operation possible
- › Compact design
- › LED-status indicator
- › Advanced diagnostics
- › Electrically isolated to the backplane bus
- › Profile rail construction
- › 24 month warranty



Overview

Order no.	Name/Description	Page
Fieldbus slave modules w/o I/Os		
353-1DP01	IM 353DP - PROFIBUS-DP slave ▶ PROFIBUS-DP slave (DP-V0, DP-V1) ▶ For max. 29 peripheral modules (16 analog) ▶ 244 Byte input and 244 Byte output data ▶ Integrated DC 24 V power supply	544

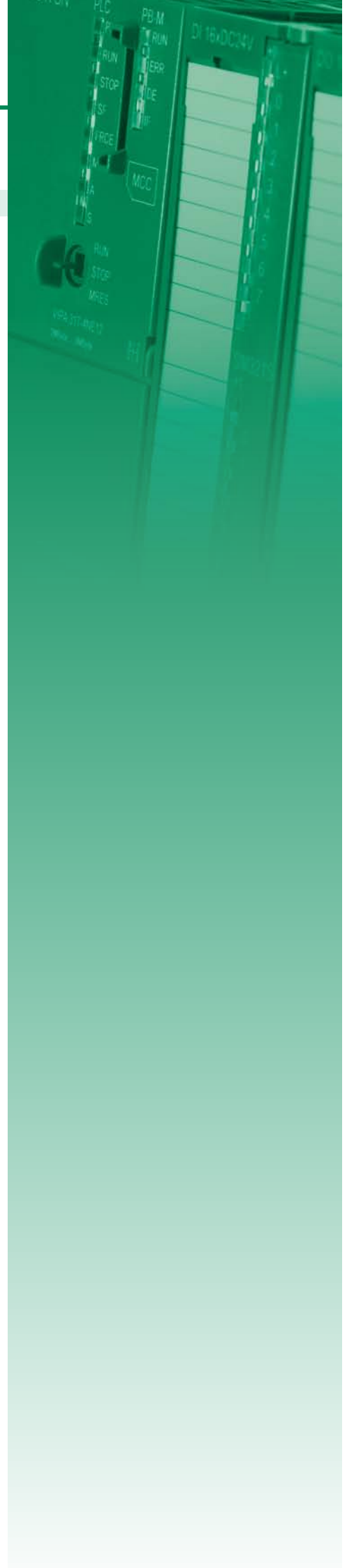

Fieldbus slave modules w/o I/Os

Interface modules Fieldbus slave modules w/o I/Os						
353-1DP01						

Order number	353-1DP01			
Figure				
Type	IM 353DP			
General information				
Note	-			
Features	<ul style="list-style-type: none"> ▸ PROFIBUS-DP slave (DP-V0, DP-V1) ▸ For max. 29 peripheral modules (16 analog) ▸ 244 Byte input and 244 Byte output data ▸ Integrated DC 24 V power supply 			
SPEED-Bus	-			
Technical data power supply				
Power supply (rated value)	DC 24 V			
Power supply (permitted range)	DC 20.4...28.8 V			
Reverse polarity protection	✓			
Current consumption (no-load operation)	70 mA			
Current consumption (rated value)	1 A			
Inrush current	60 A			
I²t	0.45 A²s			
Max. current drain at backplane bus	3.5 A			
Max. current drain load supply	-			
Power loss	2.5 W			
Status information, alarms, diagnostics				
Status display	yes			
Interrupts	yes, parameterizable			
Process alarm	yes, parameterizable			
Diagnostic interrupt	yes, parameterizable			
Diagnostic functions	yes, parameterizable			
Diagnostics information read-out	possible			
Supply voltage display	green LED			
Service Indicator	-			
Group error display	red LED			
Channel error display	none			
Hardware configuration				
Racks, max.	1			
Modules per rack, max.	29			
Number of digital modules, max.	29			
Number of analog modules, max.	16			

Interface modules Fieldbus slave modules w/o I/Os						
353-1DP01						

Order number	353-1DP01			
Communication				
Fieldbus	PROFIBUS-DP to EN 50170			
Type of interface	RS485			
Connector	Sub-D, 9-pin, female			
Topology	Linear bus with bus termination at both ends			
Electrically isolated	✓			
Number of participants, max.	125			
Node addresses	1 - 99			
Transmission speed, min.	9.6 kbit/s			
Transmission speed, max.	12 Mbit/s			
Address range inputs, max.	244 Byte			
Address range outputs, max.	244 Byte			
Number of TxPDOs, max.	-			
Number of RxPDOs, max.	-			
Housing				
Material	PPE			
Mounting	Rail System 300			
Mechanical data				
Dimensions (WxHxD)	40 mm x 125 mm x 120 mm			
Weight	170 g			
Environmental conditions				
Operating temperature	0 °C to 60 °C			
Storage temperature	-25 °C to 70 °C			
Certifications				
UL508 certification	yes			

- SLIO
- 100V
- 200V
- 300S
- 500S
- HMI
- Teleservice
- StarterKits
- Safety
- Solutions
- Software
- Accessories
- Appendix

Connections, Interfaces

Interface modules Fieldbus slave modules w/o I/Os						
353-1DP01						

353-1DP01



PB DP X2

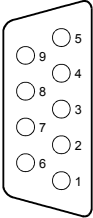

- ① n. c.
- ② n. c.
- ③ RxD/TxD-P (line B)
- ④ RTS
- ⑤ M5V
- ⑥ P5V
- ⑦ n. c.
- ⑧ RxD/TxD-N (line A)
- ⑨ n.c.

X1

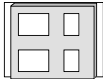

- + ① + DC 24 V
- ② 0 V

300S accessories



Structure and Function

System accessories expand the use of the system and facilitate starting.

Note: Front connectors and label strips are supplied with the modules.

Memory Extension

MMC cards can be used to store program and data. By inserting a VIPA MCC card the work memory can be expanded without exchanging the CPU.

Each CPU has an integrated memory. During the program flow, 50% of the work memory is used for the program code and 50% for data.

Profile Rail with integrated High-SPEED Backplane Bus

Various SPEED7 CPUs are equipped with a parallel SPEED-Bus, which enables the additional connection of up to 10 modules from the SPEED-Bus peripheral. While, the standard I/O modules are plugged right of the CPU and connected via single-bus connector, the connection of the SPEED-Bus I/O modules takes place via the SPEED-Bus connector strip integrated in the profile rail left of the CPU.

Front Connectors

For signal modules and CPUs with integrated peripherals appropriate front connector with spring clamp or screw terminals are available.

Manuals

The technical documentation of the respective modules encompasses various manuals with the necessary hardware and programming information, detailed descriptions of each module, and instructions for structure and assembly.



Memory extensions



Order number	Type	Description	Note
953-0KX10	MMC - MultiMediaCard	Extension memory for VIPA CPUs 11x, 21x, 24x, 31x, 51x, and 208-1DP01, CC 03 (for load memory not necessary)	
953-1LE00	Memory Configuration Card (MCC) 32kByte	for SPEED7 CPUs, 16kByte program/16kByte data	
953-1LF00	Memory Configuration Card (MCC) 64kByte	for SPEED7 CPUs, 32kByte program/32kByte data	
953-1LG00	Memory Configuration Card (MCC) 128kByte	for SPEED7 CPUs, 64kByte program/64kByte data	
953-1LH00	Memory Configuration Card (MCC) 256kByte	for SPEED7 CPUs, 128kByte program/128kByte data	
953-1LJ00	Memory Configuration Card (MCC) 512kByte	for SPEED7 CPUs, 256kByte program/256kByte data	
953-1LK00	Memory Configuration Card (MCC) 1MByte	for SPEED7 CPUs, 512kByte program/512kByte data	
953-1LL00	Memory Configuration Card (MCC) 2MByte	for SPEED7 CPUs, 1MByte program/1MByte data	
953-1LM00	Memory Configuration Card (MCC) 4MByte	for SPEED7 CPUs, 2MByte program/2MByte data	
953-1LP00	Memory Configuration Card (MCC) 8MByte	for SPEED7 CPUs, 4MByte program/4MByte data	

Configuration and diagnosis modules

Order number	Type	Description	Note
342-0IA01	CP 342 IBS - Configuration/diagnosis module	LC display, 7 buttons, cable 0.5 m, RJ45 plug, for 342-2IA71	

Profile rail



Order number	Type	Description	Note
391-1AF10	BP 391 - SPEED-Bus	Profile rail, 530 mm with integrated High-SPEED rear panel bus for 2 expansion slots	
391-1AF30	BP 391 - SPEED-Bus	Profile rail, 530 mm with integrated High-SPEED rear panel bus for 6 expansion slots	
391-1AF50	BP 391 - SPEED-Bus	Profile rail, 530 mm with integrated High-SPEED rear panel bus for 10 expansion slots	

Order number	Type	Description	Note
391-1AJ10	BP 391 - SPEED-Bus	Profile rail, 830 mm with integrated High-SPEED rear panel bus for 2 expansion slots, left justified	
391-1AJ30	BP 391 - SPEED-Bus	Profile rail, 830 mm with integrated High-SPEED rear panel bus for 6 expansion slots, left justified	
391-1AJ50	BP 391 - SPEED-Bus	Profile rail, 830 mm with integrated High-SPEED rear panel bus for 10 expansion slots, left justified	
390-1AB60	Profile rail	Length: 160 mm	
390-1AE80	Profile rail	Length: 482 mm	
390-1AF30	Profile rail	Length: 530 mm	
390-1AJ30	Profile rail	Length: 830 mm	
390-9AB60	Profile rail	Length: 160 mm, ECO pack: 100 pieces	
390-9AE80	Profile rail	Length: 482 mm, ECO pack: 32 pieces	
390-9AF30	Profile rail	Length: 530 mm, ECO pack: 32 pieces	
390-9AJ30	Profile rail	Length: 830 mm, ECO pack: 20 pieces	
390-9BC00	Profile rail	Length: 2000 mm, ECO pack: 10 pieces	

Front connector



Order number	Type	Description	Note
392-1BJ00	Front connector	20pole with cage clamps	
392-1AJ00	Front connector	20pole with screw contact	
392-9AJ00	Front connector	20pole with screw contact, ECO pack: 100 pieces	
392-1BM01	Front connector	40pole with cage clamps	
392-1AM00	Front connector	40pole with screw contact	
392-9AM00	Front connector	40pole with screw contact, ECO pack: 100 pieces	
922-3BC50	Preassembled front connectors	with screw contact, for 300 series, 2.5m, 20 pin with 20 single cores 0,5 mm ² , all the wires are marked at regular intervals with wire numbers	
922-3BD20	Preassembled front connectors	with screw contact, for 300 series, 3.2m, 20 pin with 20 single cores 0,5 mm ² , all the wires are marked at regular intervals with wire numbers	
922-3BF00	Preassembled front connectors	with screw contact, for 300 series, 5.0m, 20 pin with 20 single cores 0,5 mm ² , all the wires are marked at regular intervals with wire numbers	
922-6BC50	Preassembled front connectors	with screw contact, for 300 series, 2.5m, 40 pin with 40 single cores 0,5 mm ² , all the wires are marked at regular intervals with wire numbers	
922-6BD20	Preassembled front connectors	with screw contact, for 300 series, 3.2m, 40 pin with 40 single cores 0,5 mm ² , all the wires are marked at regular intervals with wire numbers	
922-6BF00	Preassembled front connectors	with screw contact, for 300 series, 5.0m, 40 pin with 40 single cores 0,5 mm ² , all the wires are marked at regular intervals with wire numbers	

Manuals and operating instructions



Order number	Title	Contents	Language
HB130D	Manual System 300V - Compendium, German	HB130D_PS, HB130D_CP, HB130D_FM, HB130D_IM	DE
HB130E	Manual System 300V - Compendium, English	HB130E_PS, HB130E_CP, HB130E_FM, HB130E_IM	EN
HB130D_CP	Manual System 300V - German	CP 34x Communication processors	DE
HB130E_CP	Manual System 300V - English	CP 34x Communication processors	EN
HB130D_IM	Manual System 300V - German	IM - Interface modules	DE
HB130E_IM	Manual System 300V - English	IM - Interface modules	EN
HB130D_PS	Manual System 300V - German	PS - Power supply	DE
HB130E_PS	Manual System 300V - English	PS - Power supply	EN
HB140D	Manual System 300S - SPEED7, Compendium, German	HB140D_PS, HB140D_SM-AIO, HB140D_SM-DIO, HB140D_CP	DE
HB140E	Manual System 300S - SPEED7, Compendium, English	HB140E_PS, HB140E_SM-AIO, HB140E_SM-DIO, HB140E_CP	EN
HB140D_CP	Manual System 300S - SPEED7, German	CP 34x SPEED bus communication processors	DE
HB140E_CP	Manual System 300S - SPEED7, English	CP 34x SPEED-Bus communication processors	EN
HB140D_CPU	Manual System 300S - SPEED7, German	CPU 31xS, incl. operations list	DE
HB140E_CPU	Manual System 300S - SPEED7, English	CPU 31xS, incl. operations list	EN
HB140D_CPU_SC	Manual System 300S - SPEED7, German	CPU 31xSC, incl. operations list	DE
HB140E_CPU_SC	Manual System 300S - SPEED7, English	CPU 31xSC, incl. operations list	EN
HB140D_PS	Manual System 300S - SPEED7, German	PS - SPEED-Bus power supply	DE
HB140E_PS	Manual System 300S - SPEED7, English	PS - SPEED-Bus power supply	EN
HB140D_SM-AIO	Manual System 300S, German	SM-AIO - SPEED-Bus analog signal modules	DE
HB140E_SM-AIO	Manual System 300S, English	SM-AIO - SPEED-Bus analog signal modules	EN
HB140D_SM-DIO	Manual System 300S - German	SM-DIO - SPEED bus digital Signal modules	DE
HB140E_SM-DIO	Manual System 300S - English	SM-DIO - SPEED bus digital Signal modules	EN
HB144D_IBS-DIAG	Manual CP 342 IBS-DIAG German	Manual CP 342 IBS-DIAG for configuration / diagnosis module 342-0IA00 or 342-0IA01	DE
HB144E_IBS-DIAG	Manual CP 342 IBS-DIAG English	Manual CP 342 IBS-DIAG for configuration / diagnosis module 342-0IA00 or 342-0IA01	EN

At a glance

System description 500S	554
CPUs	556
500S accessories	566

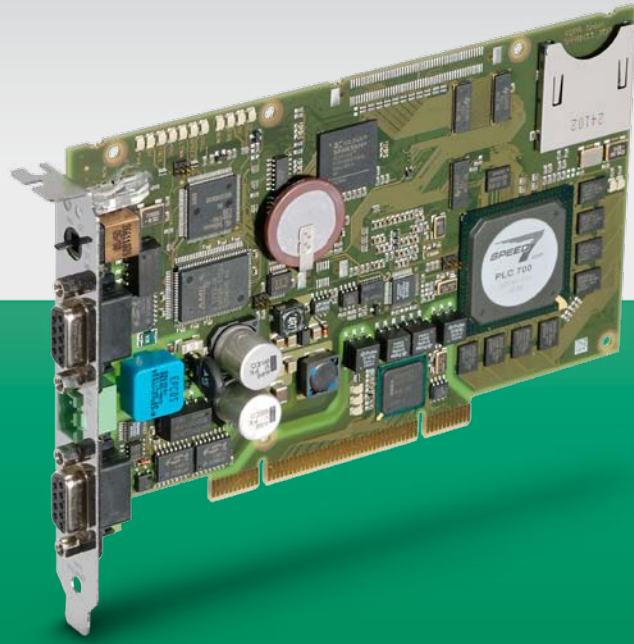

| 500S

System description 500S

Structure and Concept

The Slot PLC, based on the SPEED7 technology is designed for use within the core of a PC with a PCI interface.

500S can be extended with up to 124 PROFIBUS-DP slave stations. Thereby all systems from VIPA can be used with PROFIBUS-DP slave peripherals.

The CPU is supplied with power externally, for example with an interconnected UPS, thereby autarchic operation is possible and the operation of the CPU is also secured during a power outage.

Operation and monitoring of the CPU are supported by the program "PLCTool". The tool provides schematic representation of a CPU from 300S with all status LEDs on the PC monitor.

An OPC server for communication between the CPU and PC is included in the delivery.

Due to the module size, the CPUs fit into any standard desktop PC.

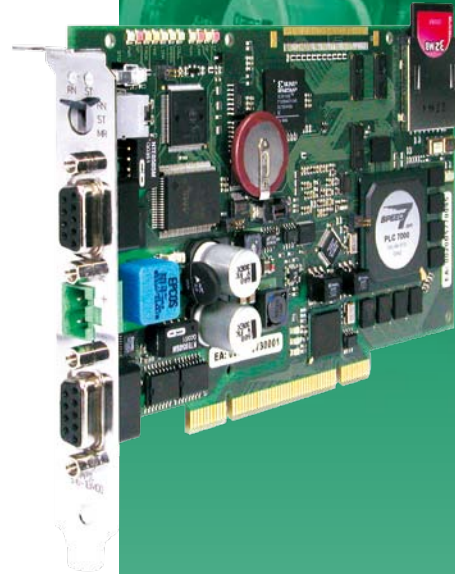

Performance and Application

500S is designed for centralized automation tasks for application within a PC with a PCI interface. It covers all requirements in the manufacturing and process industries up to the highest power range. With 500S CPU integrated SPEED7 ASIC the system is among the fastest automation systems worldwide.

Programming

500S is programmed with VIPA WinPLC7 or with STEP7 from Siemens in LAD, FBD and STL.

Memory

The CPUs in 500S have the work and load memory already integrated. Depending on the CPU-memory variant of the different users are available. The work and load memory can be adapted to the needs of memory card by plugging in an MCC memory expansion card. To back up program and data MMC cards are also supported.

Functions

Signal, communication and function modules, and devices with PROFIBUS-DP slave interfaces are connected via the integrated PROFIBUS-DP master interface.

Communication

An Ethernet programming interface is integrated on all CPUs in 500S. The integrated Ethernet communication processor CP 543 or a network card integrated in the PC link 500S horizontally and vertically into network structures. Therefore, all relevant data is made available to the connected host systems. The CPUs in 500S already have a PROFIBUS-DP master interface integrated, therefore the system can act, manufacturer-independent, as master control.

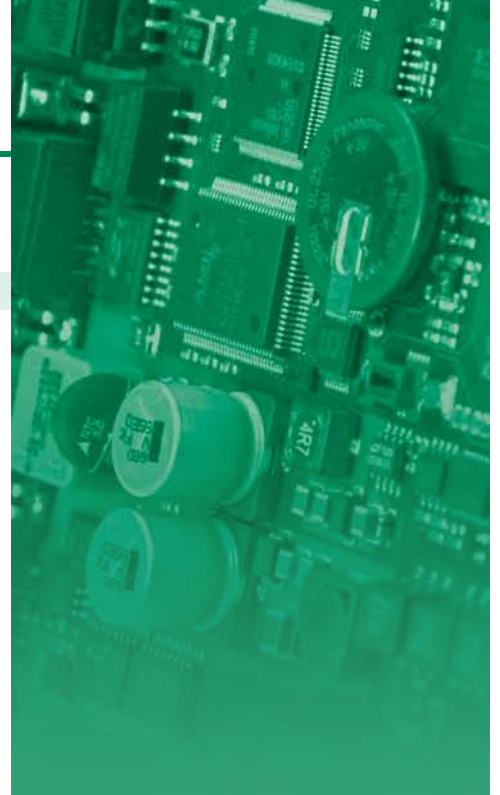

CPUs



CPUs-Central Modules

System 500S CPU SPEED7 represents a full PLC CPU in the form of a PCI bus card for PC-based applications. Windows operating systems 98, ME, NT4, 2000, XP and W7-32bit are supported.

The scope of performance corresponds to that of a SPEED7 CPU from System 300S. Programming is done using the standard programming tools VIPA WinPLC7 or Siemens STEP7.

For the connection to the process level, an MPI and a PROFIBUS-DP master interface are available. In addition, depending on the CPU type, a CP 543 for communication tasks is integrated. The scope of supply includes the OPC Server.

After the hardware installation, the plug-in card from the PC is connected as "Intel Ethernet integrated interface". To operate the card independent from the PC, it will be supplied externally with DC 24 V.

In the CPUs of System 500S memory for code and data is already integrated. It can be expanded by inserting a MCC memory card into the MMC slot. To back up program and data MMC cards are also supported.

Due to the high performance and scalable memory, the CPUs of System 500S are especially suitable for complex control tasks.

Operation Safety

- › External power supply for the CPU (autarchic operation)
- › ESD / Burst 61000-4-2/IEC in accordance with IEC 61000-4-4 (up to level 3)
- › Shock resistance in accordance with IEC 60068-2-6 / IEC 60068-2-27 (1G/12G)

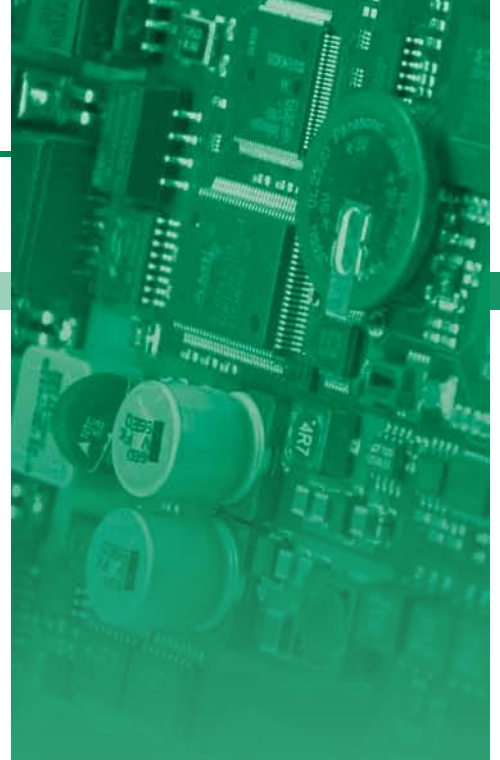



Overview

Order no.	Name/Description	Page
CPUs		
515-2AJ02	CPU 515S/DPM - SPEED7 technology ▶ SPEED7 technology ▶ 1 MB work memory ▶ Memory extension (max. 2 MB) ▶ PROFIBUS-DP master	558
517-2AJ02	CPU 517S/DPM - SPEED7 technology ▶ SPEED7 technology ▶ 2 MB work memory ▶ Memory extension (max. 8 MB) ▶ PROFIBUS-DP master	558
517-4NE02	CPU 517SN/NET - SPEED7 technology ▶ SPEED7 technology ▶ 2 MB work memory ▶ Memory extension (max. 8 MB) ▶ PROFIBUS-DP master and CP 543	558

CPUs

CPUs CPUs						
515-2AJ02						
517-2AJ02						
517-4NE02						

Order number	515-2AJ02	517-2AJ02	517-4NE02	
Figure				
Type	CPU 515S/DPM	CPU 517S/DPM	CPU 517SN/NET	
General information				
Note	-	-	-	
Features	<ul style="list-style-type: none"> ▸ SPEED7 technology ▸ 1 MB work memory ▸ Memory extension (max. 2 MB) ▸ PROFIBUS-DP master 	<ul style="list-style-type: none"> ▸ SPEED7 technology ▸ 2 MB work memory ▸ Memory extension (max. 8 MB) ▸ PROFIBUS-DP master 	<ul style="list-style-type: none"> ▸ SPEED7 technology ▸ 2 MB work memory ▸ Memory extension (max. 8 MB) ▸ PROFIBUS-DP master and CP 543 	
Technical data power supply				
Power supply (rated value)	DC 24 V	DC 24 V	DC 24 V	
Power supply (permitted range)	DC 20.4...28.8 V	DC 20.4...28.8 V	DC 20.4...28.8 V	
Reverse polarity protection	✓	✓	✓	
Current consumption (no-load operation)	250 mA	250 mA	300 mA	
Current consumption (rated value)	1 A	1 A	1.2 A	
Inrush current	5 A	5 A	5 A	
I^2t	0.5 A ² s	0.5 A ² s	0.5 A ² s	
Max. current drain at backplane bus	-	-	-	
Power loss	5 W	5 W	6.5 W	
Load and working memory				
Load memory, integrated	2 MB	8 MB	8 MB	
Load memory, maximum	2 MB	8 MB	8 MB	
Work memory, integrated	1 MB	2 MB	2 MB	
Work memory, maximal	2 MB	8 MB	8 MB	
Memory divided in 50% program / 50% data	✓	✓	✓	
Memory card slot	MMC-Card with max. 1 GB	MMC-Card with max. 1 GB	MMC-Card with max. 1 GB	
Hardware configuration				
Racks, max.	-	-	-	
Modules per rack, max.	-	-	-	
Number of integrated DP master	1	1	1	
Number of DP master via CP	-	-	-	
Operable function modules	-	-	-	
Operable communication modules PtP	-	-	-	
Operable communication modules LAN	-	-	-	
Command processing times				
Bit instructions, min.	0.01 μs	0.01 μs	0.01 μs	
Word instruction, min.	0.01 μs	0.01 μs	0.01 μs	
Double integer arithmetic, min.	0.01 μs	0.01 μs	0.01 μs	
Floating-point arithmetic, min.	0.06 μs	0.06 μs	0.06 μs	

CPU5 CPU5						
515-2AJ02						
517-2AJ02						
517-4NE02						

Order number	515-2AJ02	517-2AJ02	517-4NE02	
Timers/Counters and their retentive characteristics				
Number of S7 counters	512	2048	2048	
S7 counter remanence	adjustable 0 up to 512	adjustable 0 up to 2048	adjustable 0 up to 2048	
S7 counter remanence adjustable	C0 .. C7	C0 .. C7	C0 .. C7	
Number of S7 times	512	2048	2048	
S7 times remanence	adjustable 0 up to 512	adjustable 0 up to 2048	adjustable 0 up to 2048	
S7 times remanence adjustable	not retentive	not retentive	not retentive	
Data range and retentive characteristic				
Number of flags	8192 Byte	16384 Byte	16384 Byte	
Bit memories retentive characteristic adjustable	adjustable 0 up to 8192	adjustable 0 up to 16384	adjustable 0 up to 16384	
Bit memories retentive characteristic preset	MB0 .. MB15	MB0 .. MB15	MB0 .. MB15	
Number of data blocks	4095	8190	8190	
Max. data blocks size	64 KB	64 KB	64 KB	
Number range DBs	1 ... 4095	1 ... 8190	1 ... 8190	
Max. local data size per execution level	510 Byte	510 Byte	510 Byte	
Max. local data size per block	-	-	-	
Blocks				
Number of OBs	24	24	24	
Maximum OB size	64 KB	64 KB	64 KB	
Total number DBs, FBs, FCs	-	-	-	
Number of FBs	2048	8191	8191	
Maximum FB size	64 KB	64 KB	64 KB	
Number range FBs	0 ... 2047	0 ... 8190	0 ... 8190	
Number of FCs	2048	8191	8191	
Maximum FC size	64 KB	64 KB	64 KB	
Number range FC2	0 ... 2047	0 ... 8190	0 ... 8190	
Maximum nesting depth per priority class	8	8	8	
Maximum nesting depth additional within an error OB	4	4	4	
Time				
Real-time clock buffered	✓	✓	✓	
Clock buffered period (min.)	6 w	6 w	6 w	
Type of buffering	-	-	-	
Load time for 50% buffering period	20 h	20 h	20 h	
Load time for 100% buffering period	48 h	48 h	48 h	
Accuracy (max. deviation per day)	10 s	10 s	10 s	
Number of operating hours counter	8	8	8	
Clock synchronization	✓	✓	✓	
Synchronization via MPI	Master/Slave	Master/Slave	Master/Slave	
Synchronization via Ethernet (NTP)	no	no	Slave	
Address areas (I/O)				
Input I/O address area	8192 Byte	8192 Byte	8192 Byte	
Output I/O address area	8192 Byte	8192 Byte	8192 Byte	
Process image adjustable	✓	✓	✓	

SLIO
100V
200V
300S
500S
HMI
Teleservice
StarterKits
Safety
Solutions
Software
Accessories
Appendix

CPUs CPUs						
515-2AJ02						
517-2AJ02						
517-4NE02						

Order number	515-2AJ02	517-2AJ02	517-4NE02	
Input process image preset	256 Byte	256 Byte	256 Byte	
Output process image preset	256 Byte	256 Byte	256 Byte	
Input process image maximal	2048 Byte	8192 Byte	8192 Byte	
Output process image maximal	2048 Byte	8192 Byte	8192 Byte	
Digital inputs	65536	65536	65536	
Digital outputs	65536	65536	65536	
Digital inputs central	-	-	-	
Digital outputs central	-	-	-	
Integrated digital inputs	-	-	-	
Integrated digital outputs	-	-	-	
Analog inputs	4096	4096	4096	
Analog outputs	4096	4096	4096	
Analog inputs, central	-	-	-	
Analog outputs, central	-	-	-	
Integrated analog inputs	-	-	-	
Integrated analog outputs	-	-	-	
Communication functions				
PG/OP channel	✓	✓	✓	
Global data communication	✓	✓	✓	
Number of GD circuits, max.	16	16	16	
Size of GD packets, max.	54 Byte	54 Byte	54 Byte	
S7 basic communication	✓	✓	✓	
S7 basic communication, user data per job	76 Byte	76 Byte	76 Byte	
S7 communication	✓	✓	✓	
S7 communication as server	✓	✓	✓	
S7 communication as client	-	-	-	
S7 communication, user data per job	160 Byte	160 Byte	160 Byte	
Number of connections, max.	32	32	32	
Functionality Sub-D interfaces				
Type	X2	X2	X2	
Type of interface	RS485	RS485	RS485	
Connector	Sub-D, 9-pin, female	Sub-D, 9-pin, female	Sub-D, 9-pin, female	
Electrically isolated	✓	✓	✓	
MPI	✓	✓	✓	
MP ² I (MPI/RS232)	-	-	-	
DP master	-	-	-	
DP slave	-	-	-	
Point-to-point interface	-	-	-	
Functionality Sub-C interfaces				
Type	X3	X3	X3	
Type of interface	RS485	RS485	RS485	
Connector	Sub-D, 9-pin, female	Sub-D, 9-pin, female	Sub-D, 9-pin, female	
Electrically isolated	✓	✓	✓	
MPI	-	-	-	
MP ² I (MPI/RS232)	-	-	-	

CPU5 CPU5						
515-2AJ02						
517-2AJ02						
517-4NE02						

Order number	515-2AJ02	517-2AJ02	517-4NE02	
DP master	yes	yes	yes	
DP slave	yes	yes	yes	
Point-to-point interface	-	-	-	
Functionality MPI				
Number of connections, max.	32	32	32	
PG/OP channel	✓	✓	✓	
Routing	✓	✓	✓	
Global data communication	✓	✓	✓	
S7 basic communication	✓	✓	✓	
S7 communication	✓	✓	✓	
S7 communication as server	✓	✓	✓	
S7 communication as client	-	-	-	
Transmission speed, min.	19.2 kbit/s	19.2 kbit/s	19.2 kbit/s	
Transmission speed, max.	12 Mbit/s	12 Mbit/s	12 Mbit/s	
Functionality PROFIBUS master				
PG/OP channel	✓	✓	✓	
Routing	✓	✓	✓	
S7 basic communication	✓	✓	✓	
S7 communication	✓	✓	✓	
S7 communication as server	✓	✓	✓	
S7 communication as client	-	-	-	
Activation/deactivation of DP slaves	✓	✓	✓	
Direct data exchange (slave-to-slave communication)	-	-	-	
DPV1	✓	✓	✓	
Transmission speed, min.	9.6 kbit/s	9.6 kbit/s	9.6 kbit/s	
Transmission speed, max.	12 Mbit/s	12 Mbit/s	12 Mbit/s	
Number of DP slaves, max.	32	32	32	
Address range inputs, max.	1 KB	1 KB	1 KB	
Address range outputs, max.	1 KB	1 KB	1 KB	
User data inputs per slave, max.	244 Byte	244 Byte	244 Byte	
User data outputs per slave, max.	244 Byte	244 Byte	244 Byte	
Functionality PROFIBUS slave				
PG/OP channel	✓	✓	✓	
Routing	✓	✓	✓	
S7 communication	✓	✓	✓	
S7 communication as server	✓	✓	✓	
S7 communication as client	-	-	-	
Direct data exchange (slave-to-slave communication)	-	-	-	
DPV1	✓	✓	✓	
Transmission speed, min.	9.6 kbit/s	9.6 kbit/s	9.6 kbit/s	
Transmission speed, max.	12 Mbit/s	12 Mbit/s	12 Mbit/s	
Automatic detection of transmission speed	-	-	-	
Transfer memory inputs, max.	244 Byte	244 Byte	244 Byte	
Transfer memory outputs, max.	244 Byte	244 Byte	244 Byte	

CPUs CPUs						
515-2AJ02						
517-2AJ02						
517-4NE02						

Order number	515-2AJ02	517-2AJ02	517-4NE02	
Address areas, max.	32	32	32	
User data per address area, max.	32 Byte	32 Byte	32 Byte	
Functionality RJ45 interfaces				
Type	n/d	n/d	n/d	
Type of interface	Ethernet 10/100 MBit	Ethernet 10/100 MBit	Ethernet 10/100 MBit	
Connector	PCI bus	PCI bus	PCI bus	
Electrically isolated	✓	✓	-	
PG/OP channel	✓	✓	✓	
Number of connections, max.	4	4	4	
Productive connections	-	-	-	
Type	-	-	X4	
Type of interface	-	-	Ethernet 10/100 MBit	
Connector	-	-	RJ45	
Electrically isolated	-	-	✓	
PG/OP channel	-	-	✓	
Number of connections, max.	-	-	32	
Productive connections	-	-	✓	
Ethernet communication CP				
Number of productive connections, max.	-	-	64	
Number of productive connections by Siemens NetPro, max.	-	-	16	
S7 connections	-	-	USEND, URCV, BSEND, BRCV, GET, PUT, Connection of active and passive data handling	
User data per S7 connection, max.	-	-	32 KB	
TCP-connections	-	-	SEND, RECEIVE, FETCH PASSIV, WRITE PASSIV, Connection of active and passive data handling	
User data per TCP connection, max.	-	-	64 KB	
ISO-connections	-	-	SEND, RECEIVE, FETCH PASSIV, WRITE PASSIV, Connection of active and passive data handling	
User data per ISO connection, max.	-	-	8 KB	
ISO on TCP connections (RFC 1006)	-	-	SEND, RECEIVE, FETCH PASSIV, WRITE PASSIV, Connection of active and passive data handling	
User data per ISO on TCP connection, max.	-	-	32 KB	
UDP-connections	-	-	SEND and RECEIVE	
User data per UDP connection, max.	-	-	2 KB	
UDP-multicast-connections	-	-	SEND and RECEIVE (max. 16 Multicast groups)	
UDP-broadcast-connections	-	-	SEND	

CPU5 CPU5						
515-2AJ02						
517-2AJ02						
517-4NE02						

Order number	515-2AJ02	517-2AJ02	517-4NE02	
Ethernet open communication				
Number of connections, max.	-	-	8	
User data per ISO on TCP connection, max.	-	-	8 KB	
User data per native TCP connection, max.	-	-	8 KB	
User data per ad hoc TCP connection, max.	-	-	1460 Byte	
User data per UDP connection, max.	-	-	1472 Byte	
Housing				
Material	-	-	-	
Mounting	-	-	-	
Mechanical data				
Dimensions (WxHxD)	20 mm x 106 mm x 174 mm	20 mm x 106 mm x 174 mm	40 mm x 106 mm x 174 mm	
Weight	280 g	290 g	390 g	
Environmental conditions				
Operating temperature	0 °C to 60 °C	0 °C to 60 °C	0 °C to 60 °C	
Storage temperature	-25 °C to 70 °C	-25 °C to 70 °C	-25 °C to 70 °C	
Certifications				
UL508 certification	in preparation	in preparation	in preparation	

Connections, Interfaces

CPU | CPUs

515-2AJ02
517-2AJ02
517-4NE02

515-2AJ02



DP master

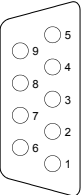

- ① shield
- ② M24V
- ③ RxD/TxD-P (line B)
- ④ RTS
- ⑤ M5V
- ⑥ P5V
- ⑦ P24V
- ⑧ RxD/TxD-N (line A)
- ⑨ n.c.

MPI

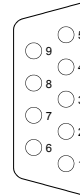

- ① reserved
- ② M24V
- ③ RxD/TxD-P (line B)
- ④ RTS
- ⑤ M5V
- ⑥ P5V
- ⑦ P24V
- ⑧ RxD/TxD-N (line A)
- ⑨ n.c.



- ① DC 24 V
- ②

517-2AJ02



DP master

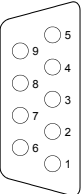

- ① shield
- ② M24V
- ③ RxD/TxD-P (line B)
- ④ RTS
- ⑤ M5V
- ⑥ P5V
- ⑦ P24V
- ⑧ RxD/TxD-N (line A)
- ⑨ n.c.

MPI

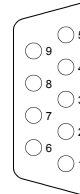

- ① reserved
- ② M24V
- ③ RxD/TxD-P (line B)
- ④ RTS
- ⑤ M5V
- ⑥ P5V
- ⑦ P24V
- ⑧ RxD/TxD-N (line A)
- ⑨ n.c.



- ① DC 24 V
- ②

517-4NE02

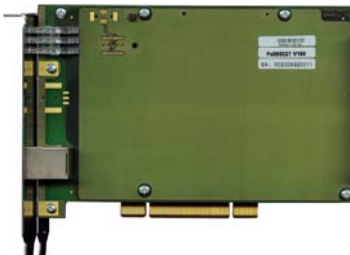

DP master

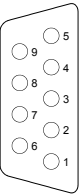

- ① shield
- ② M24V
- ③ RxD/TxD-P (line B)
- ④ RTS
- ⑤ M5V
- ⑥ P5V
- ⑦ P24V
- ⑧ RxD/TxD-N (line A)
- ⑨ n.c.

MPI

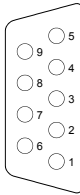

- ① reserved
- ② M24V
- ③ RxD/TxD-P (line B)
- ④ RTS
- ⑤ M5V
- ⑥ P5V
- ⑦ P24V
- ⑧ RxD/TxD-N (line A)
- ⑨ n.c.



- ① DC 24 V
- ②

CP 543 RJ45



- ① Transmit +
- ② Transmit -
- ③ Receive +
- ④ -
- ⑤ -
- ⑥ Receive -
- ⑦ -
- ⑧ -

500S accessories



Structure and Function

System accessories enable and expand the use of the system and facilitate starting.

Memory Expansion

MMC cards can be used for storing programs and data. By inserting a VIPA-MCC card the work memory is expanded without exchanging the CPU.

Each CPU has an integrated work memory. During the program flow, 50% of the work memory is used for the program code and 50% for data.

Manuals

The technical documentation of the respective modules encompasses various manuals with the necessary hardware and programming information, detailed descriptions of each module, and instructions for structure and assembly.

Memory extensions



Order number	Type	Description	Note
953-0KX10	MMC - MultiMediaCard	Extension memory for VIPA CPUs 11x, 21x, 24x, 31x, 51x, and 208-1DP01, CC 03 (for load memory not necessary)	
953-1LE00	Memory Configuration Card (MCC) 32kByte	for SPEED7 CPUs, 16kByte program/16kByte data	
953-1LF00	Memory Configuration Card (MCC) 64kByte	for SPEED7 CPUs, 32kByte program/32kByte data	
953-1LG00	Memory Configuration Card (MCC) 128kByte	for SPEED7 CPUs, 64kByte program/64kByte data	
953-1LH00	Memory Configuration Card (MCC) 256kByte	for SPEED7 CPUs, 128kByte program/128kByte data	
953-1LJ00	Memory Configuration Card (MCC) 512kByte	for SPEED7 CPUs, 256kByte program/256kByte data	
953-1LK00	Memory Configuration Card (MCC) 1MByte	for SPEED7 CPUs, 512kByte program/512kByte data	
953-1LL00	Memory Configuration Card (MCC) 2MByte	for SPEED7 CPUs, 1MByte program/1MByte data	
953-1LM00	Memory Configuration Card (MCC) 4MByte	for SPEED7 CPUs, 2MByte program/2MByte data	
953-1LP00	Memory Configuration Card (MCC) 8MByte	for SPEED7 CPUs, 4MByte program/4MByte data	

Manuals



Order number	Title	Contents	Language
HB145D_CPU	Manual System 500S - SPEED7, German	PCI CPU 51xS, incl. operations list	DE
HB145E_CPU	Manual System 500S - SPEED7, English	PCI CPU 51xS, incl. operations list	EN

At a glance



System description HMI	570
Lines displays	572
professional Panels	594
eco Panels	608
Panel PC	620
HMI software	630
HMI accessories	634



| HMI

System description HMI

Structure and Concept

The VIPA professional Touch Panels with 4,3" to 12,1" TFT display, the Windows Embedded CE 6.0 operating system, and the Movicon 11 visualization system can be used universally.

The VIPA eco Panels in four different display sizes from 4,3" to 15" are characterized by absolute reliability and flexibility and also special longevity and quality because of the special construction.

The VIPA panel PCs in the display sizes 15,6" und 21,5" are a combination of industrial PC with the most modern features and a Touch Panel with optimum display possibilities. The latest Intel Atom Processor technology combined with Windows Embedded Compact 7 or Standard 7 operating systems correspond to state of the art in the PC world.

The VIPA Commander Compact CC 03 with double spaced display and integrated PLC CPU is the ideal device for smaller controlling and operating tasks.

The VIPA Operator Panel OP 03 and the Text Display TD 03 are universal operating units for deployment with VIPA systems and other control systems with MPI interface.



Performance and deployment

VIPA operating and monitoring devices are universal in the manufacturing and process industry, but can also be used in building automation. The line displays and touch panels are designed both for watching and for active operation of machinery, plant and building.

Parameterization and programming

The Text Display TD 03 are parameterized with the free Tool TD Wizard *). The Operator Panel OP 03 and the Commander Compact CC 03 devices are configured with the OP Manager or alternatively with Siemens ProTool. The PLC CPUs, integrated in Commander Compact CC 03, are programmed in addition via VIPA WinPLC7 or Siemens STEP7. The basis for the Touch Panels is Windows Embedded CE operating system from Microsoft. Here the applications and visualizations offered by VIPA (also partially their own) are ported. VIPA Touch Panels are shipped with pre-installed operating system and Movicon. The project, created with the appropriate editor on the PC, is transferred via data cable or memory card from the PC to the Touch Panel.

Memory

The Text Display TD 03 has no built-in memory. The messages, generated with TD-Wizard, are stored in the CPU. The Operator Panel OP 03 make 256 kByte and the Commander Compact CC 03 devices 128 kByte work memory available for projects. Incorporated in the Commander Compact CC 03 devices is an additional 16/24/32 kByte work memory for the PLC program. The touch panels offer up to 2048 MB of user memory (depending on the model). External expansion of the memory can easily be achieved by inserting a CF or MMC-/SD-Card.

Functions

Depending on the device type different and very versatile functions are realizable. The Text Display TD 03 is provided primarily for the simple presentation and the acknowledgement of messages. With the Operator Panels OP 03 advanced operating and monitoring tasks are already being realized with their own projects deposited in OP 03. Touch panels have multi-functional use. Depending on the application projects with up to several thousand variables will be realized on the PC. Thereby CPUs, higher-level systems and other devices are connected for the purpose of data collection, data sharing, visualization and operation.

Communication

The exchange of data with the CPUs occurs at TD 03 and OP 03 via MPI. The Commander Compact CC 03 devices combine display and operating elements as well as PLC CPU with I/O peripherals in one casing. They can thus be used completely self-contained.

*) Downloadable on the tool Demo-CD SW900T0LA or under <http://www.vipa.com/en/service-support/downloads/software/>.

Lines displays



Structure and Function

Line displays are used for the operation and monitoring of process parameters in machinery, plant and buildings.

TD 03 – Text Display

The compact VIPA Text Display TD 03 shows via a backlit LCD display defined message texts. Inputs and outputs, and process parameters can be set through the membrane keys and changed. The configuration of the messages and the parameter block is performed using the TD-Wizard from VIPA. The menu can be selected in English and German. The text display is designed for use in combination with VIPA CPUs 11x, 21x, 31x, 51x and the S7-300/400 CPUs designed by Siemens.

OP 03 – Operator Panel

The VIPA Operator Panel OP 03 is particularly suitable for operating and monitoring of small applications in conjunction with VIPA CPUs 11x, 21x, 31x, 51x and Siemens S7-300/400 CPUs. Up to seven OPs can be connected to a CPU and up to 2 CPUs to an OP 03 via the MPI interface. For managing and processing operating notifications and data, 256 kByte user memory is available. Project planning is carried out with VIPA OP-Manager or Siemens ProTool.

CC 03 – Commander Compact

In the VIPA Commander Compact CC 03 a PLC CPU, programmable with Siemens STEP7, is integrated. Besides the 128 kByte user memory, the CPU has 16/24/32 kByte program and 24/32/40 kByte load memory (depending on version). In addition, 16 digital inputs and outputs each are integrated. The CC 03 is expandable with up to four 100V or 200V modules (160 digital inputs/outputs, or up to 32 analog inputs/outputs respectively are supported).

Characteristics

- › Backlit LC-Display
- › Parameterization capable function keys
- › MPI-interface
- › Multilingual Language Support
- › Operation and project planning friendly
- › LED-status indicator (CC 03)
- › Compact design

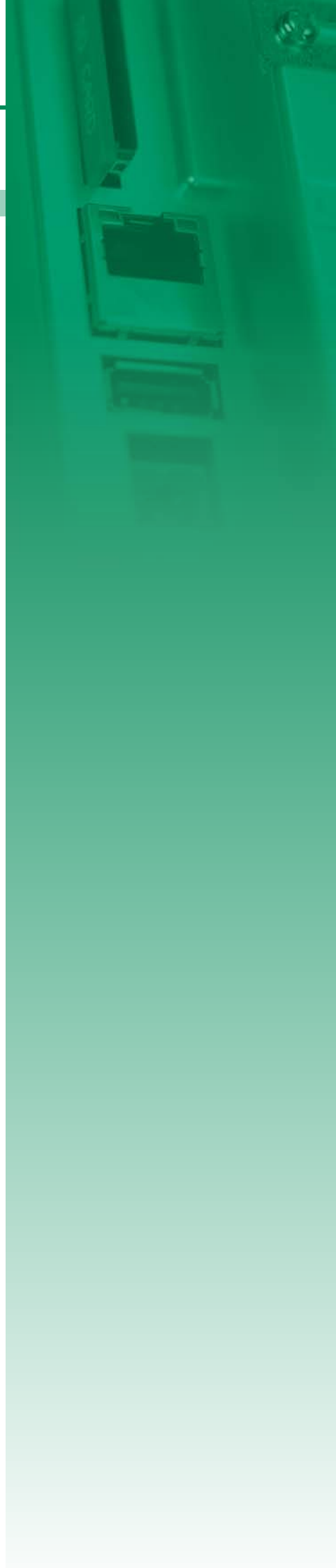



Overview

Order no.	Name/Description	Page
Text displays and operator panels		
603-1TD00	TD 03 - Text Display ▶ Display: 2 x 20 characters ▶ Interface: MP ² _I ▶ Languages: DE, EN, FR, ES, IT, SV, NO, DA ▶ Visualization of the connected CPU via MPI	574
603-1OP00	OP 03 - Operator Panel ▶ Display: 2 x 20 characters ▶ Interface: MP ² _I ▶ User memory: 256 kB ▶ Languages: DE, EN, FR, ES, IT, SV, NO, DA ▶ Project engineering via VIPA OP-Manager or Siemens ProTool	574
603-1OP10	OP 03 - Operator Panel ▶ Display: 2 x 20 characters ▶ Interface: MP ² _I ▶ User memory: 256 kB ▶ Languages: DE (without Umlaut), EN, RU ▶ Project engineering only via VIPA OP-Manager	574
Commander compact		
603-1CC21	CC 03 - Commander Compact ▶ Display: 2 x 20 characters ▶ Interface: MP ² _I ▶ User memory: 128 kB ▶ Languages: DE, EN, FR, ES, IT, SV, NO, DA ▶ Project engineering via VIPA OP-Manager or Siemens ProTool ▶ Integrated PLC-CPU: 16/24kByte work/load memory, 16 x DI, 16 x DO, up to 4 I/O expansion modules	577
603-1CC22	CC 03 - Commander Compact ▶ Display: 2 x 20 characters ▶ Interface: MP ² _I ▶ User memory: 128 kB ▶ Languages: DE, EN, FR, ES, IT, SV, NO, DA ▶ Project engineering via VIPA OP-Manager or Siemens ProTool ▶ Integrated PLC-CPU: 24/32kByte work/load memory, 16 x DI, 16 x DO, up to 4 I/O expansion modules	577
603-1CC23	CC 03 - Commander Compact ▶ Display: 2 x 20 characters ▶ Interface: MP ² _I ▶ User memory: 128 kB ▶ Languages: DE, EN, FR, ES, IT, SV, NO, DA ▶ Project engineering via VIPA OP-Manager or Siemens ProTool ▶ Integrated PLC-CPU: 32/40kByte work/load memory, 16 x DI, 16 x DO, up to 4 I/O expansion modules	577
603-2CC21	CC 03 - Commander Compact ▶ Display: 2 x 20 characters ▶ Interface: MP ² _I , PROFIBUS-DP slave ▶ User memory: 128 kB ▶ Languages: DE, EN, FR, ES, IT, SV, NO, DA ▶ Project engineering via VIPA OP-Manager or Siemens ProTool ▶ Integrated PLC-CPU: 16/24kByte work/load memory, 16 x DI, 16 x DO, up to 4 I/O expansion modules	577
603-2CC22	CC 03 - Commander Compact ▶ Display: 2 x 20 characters ▶ Interface: MP ² _I , PROFIBUS-DP slave ▶ User memory: 128 kB ▶ Languages: DE, EN, FR, ES, IT, SV, NO, DA ▶ Project engineering via VIPA OP-Manager or Siemens ProTool ▶ Integrated PLC-CPU: 24/32kByte work/load memory, 16 x DI, 16 x DO, up to 4 I/O expansion modules	585
603-2CC23	CC 03 - Commander Compact ▶ Display: 2 x 20 characters ▶ Interface: MP ² _I , PROFIBUS-DP slave ▶ User memory: 128 kB ▶ Languages: DE, EN, FR, ES, IT, SV, NO, DA ▶ Project engineering via VIPA OP-Manager or Siemens ProTool ▶ Integrated PLC-CPU: 32/40kByte work/load memory, 16 x DI, 16 x DO, up to 4 I/O expansion modules	585

Text displays and operator panels

Lines displays Text displays and operator panels					
603-1TD00					
603-1OP00					
603-1OP10					

Order number	603-1TD00	603-1OP00	603-1OP10	
Figure				
Type	TD 03, Text Display	OP 03, Operator Panel	OP 03, Operator Panel, en, ru	
General information				
Note	-	-	-	
Features	<ul style="list-style-type: none"> Display: 2 x 20 characters Interface: MP²I Languages: DE, EN, FR, ES, IT, SV, NO, DA Visualization of the connected CPU via MPI 	<ul style="list-style-type: none"> Display: 2 x 20 characters Interface: MP²I User memory: 256 kB Languages: DE, EN, FR, ES, IT, SV, NO, DA Project engineering via VIPA OP-Manager or Siemens ProTool 	<ul style="list-style-type: none"> Display: 2 x 20 characters Interface: MP²I User memory: 256 kB Languages: DE (without Umlaut), EN, RU Project engineering only via VIPA OP-Manager 	
Display				
Number of rows	2	2	2	
Characters per row	20	20	20	
Character height	5 mm	5 mm	5 mm	
Type of display	STN with LED back-lighting	STN with LED back-lighting	STN with LED back-lighting	
OP functionality				
User memory	-	256	256	
Number of variables	-	4096	4096	
Language	DE/EN/FR/ES/IT/SV/NO/DA	DE/EN/FR/ES/IT/SV/NO/DA	DE (w/o umlauts)/EN/RU	
Operating controls				
Touchscreen	-	-	-	
Keyboard	Membran keyboard	Membran keyboard	Membran keyboard	
Mouse	-	-	-	
Number of system keys	5	8	8	
Number of soft keys	4	5	5	
Technical data power supply				
Power supply (rated value)	DC 24 V	DC 24 V	DC 24 V	
Power supply (permitted range)	DC 20.4...28.8 V	DC 20.4...28.8 V	DC 20.4...28.8 V	
Reverse polarity protection	✓	✓	✓	
Current consumption (no-load operation)	80 mA	80 mA	80 mA	
Current consumption (rated value)	500 mA	500 mA	500 mA	
Inrush current	16 A	55 A	55 A	
I ² t	0.11 A ² s	0.34 A ² s	0.34 A ² s	

Lines displays | Text displays and operator panels

603-1TD00
603-1OP00
603-1OP10

Order number	603-1TD00	603-1OP00	603-1OP10	
Time				
Real-time clock	-	✓	✓	
Clock buffered period (min.)	-	-	-	
Accuracy (max. deviation per day)	-	-	-	
Functionality Sub-D interfaces				
Type	MP ² I	MP ² I	MP ² I	
Type of interface	RS485	RS485	RS485	
Connector	Sub-D, 9-pin, female	Sub-D, 9-pin, female	Sub-D, 9-pin, female	
Electrically isolated	-	-	-	
MPI	✓	✓	✓	
MP ² I (MPI/RS232)	✓	✓	✓	
Point-to-point interface	-	-	-	
Mechanical data				
Housing / Protection type				
Material	die-cast aluminum	die-cast aluminum	die-cast aluminum	
Mounting	via integrated pivoted lever	via integrated pivoted lever	via integrated pivoted lever	
Protect type front side	IP 65	IP 65	IP 65	
Protect type back side	IP 20	IP 20	IP 20	
Dimensions				
Front panel	187 mm x 90 mm x 6 mm	187 mm x 90 mm x 6 mm	187 mm x 90 mm x 6 mm	
Rear panel	154 mm x 77 mm x 44 mm	154 mm x 77 mm x 55 mm	154 mm x 77 mm x 55 mm	
Installation cut-out				
Width	156 mm	156 mm	156 mm	
Height	78 mm	78 mm	78 mm	
Minimum	2.5 mm	2.5 mm	2.5 mm	
Maximum front panel thickness	6 mm	6 mm	6 mm	
Weight	610 g	600 g	600 g	
Environmental conditions				
Operating temperature	0 °C to 60 °C	0 °C to 60 °C	0 °C to 60 °C	
Storage temperature	-20 °C to 70 °C	-20 °C to 70 °C	-20 °C to 70 °C	
Certifications				
UL508 certification	yes	yes	-	

Connections, Interfaces

Lines displays | Text displays and operator panels

603-1TD00
603-1OP00
603-1OP10

603-1TD00

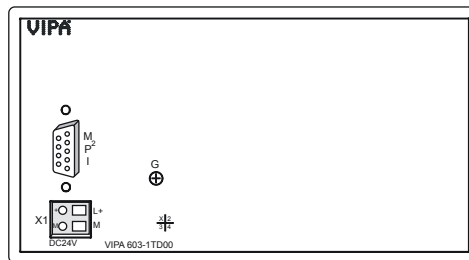
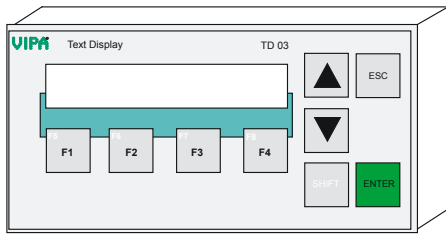

603-1OP00

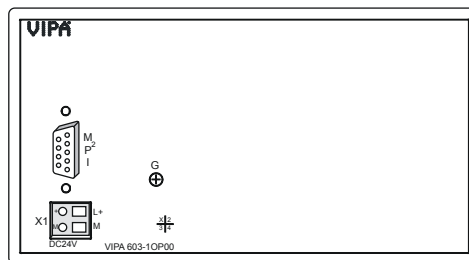
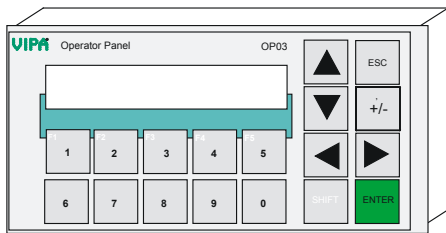



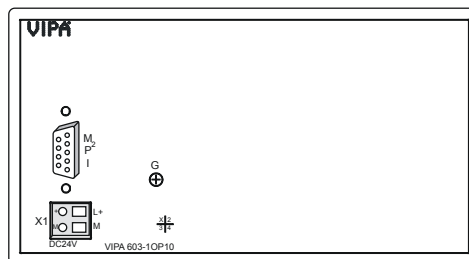
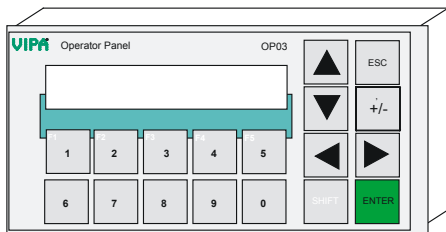

603-1OP10



Commander compact

Lines displays Commander compact					
603-1CC21	603-2CC22				
603-1CC22	603-2CC23				
603-1CC23					
603-2CC21					

Order number	603-1CC21	603-1CC22	603-1CC23	603-2CC21
Figure				
Type	CC 03, Commander Compact	CC 03, Commander Compact	CC 03, Commander Compact	CC 03DP, Commander Compact, PROFIBUS-DP slave
General information				
Note	-	-	-	-
Features	<ul style="list-style-type: none"> Display: 2 x 20 characters Interface: MP2I User memory: 128 kB Languages: DE, EN, FR, ES, IT, SV, NO, DA Project engineering via VIPA OP-Manager or Siemens ProTool Integrated PLC-CPU: 16/24kByte work/load memory, 16 x DI, 16 x DO, up to 4 I/O expansion modules 	<ul style="list-style-type: none"> Display: 2 x 20 characters Interface: MP2I User memory: 128 kB Languages: DE, EN, FR, ES, IT, SV, NO, DA Project engineering via VIPA OP-Manager or Siemens ProTool Integrated PLC-CPU: 24/32kByte work/load memory, 16 x DI, 16 x DO, up to 4 I/O expansion modules 	<ul style="list-style-type: none"> Display: 2 x 20 characters Interface: MP2I User memory: 128 kB Languages: DE, EN, FR, ES, IT, SV, NO, DA Project engineering via VIPA OP-Manager or Siemens ProTool Integrated PLC-CPU: 32/40kByte work/load memory, 16 x DI, 16 x DO, up to 4 I/O expansion modules 	<ul style="list-style-type: none"> Display: 2 x 20 characters Interface: MP2I, PROFIBUS-DP slave User memory: 128 kB Languages: DE, EN, FR, ES, IT, SV, NO, DA Project engineering via VIPA OP-Manager or Siemens ProTool Integrated PLC-CPU: 16/24kByte work/load memory, 16 x DI, 16 x DO, up to 4 I/O expansion modules
Display				
Number of rows	2	2	2	2
Characters per row	20	20	20	20
Character height	5 mm	5 mm	5 mm	5 mm
Type of display	STN with LED back-lighting	STN with LED back-lighting	STN with LED back-lighting	STN with LED back-lighting
OP functionality				
User memory	128 KB	128 KB	128 KB	128 KB
Number of variables	4096	4096	4096	4096
Language	DE/EN/FR/ES/IT/SV/NO/DA	DE/EN/FR/ES/IT/SV/NO/DA	DE/EN/FR/ES/IT/SV/NO/DA	DE/EN/FR/ES/IT/SV/NO/DA
Operating controls				
Touchscreen	-	-	-	-
Mouse	-	-	-	-
Number of system keys	8	8	8	8
Number of soft keys	5	5	5	5
Technical data power supply				
Power supply (rated value)	DC 24 V	DC 24 V	DC 24 V	DC 24 V
Power supply (permitted range)	DC 20.4...28.8 V	DC 20.4...28.8 V	DC 20.4...28.8 V	DC 20.4...28.8 V
Reverse polarity protection	✓	✓	✓	✓
Current consumption (no-load operation)	130 mA	130 mA	130 mA	150 mA
Current consumption (rated value)	1 A	1 A	1 A	1 A
Inrush current	60 A	60 A	60 A	60 A
I _{Δt}	0.35 A²s	0.35 A²s	0.35 A²s	0.35 A²s
Max. current drain at backplane bus	0.8 A	0.8 A	0.8 A	0.8 A
Power loss	8 W	8 W	8 W	8 W

SLIO
100V
200V
300S
500S
HMI
Teleservice
StarterKits
Safety
Solutions
Software
Accessories
Appendix

Lines displays Commander compact					
603-1CC21	603-2CC22				
603-1CC22	603-2CC23				
603-1CC23					
603-2CC21					

Order number	603-1CC21	603-1CC22	603-1CC23	603-2CC21
Reverse polarity protection	✓	✓	✓	✓
Technical data digital inputs				
Number of inputs	16	16	16	16
Cable length, shielded	1000 m	1000 m	1000 m	1000 m
Cable length, unshielded	600 m	600 m	600 m	600 m
Rated load voltage	DC 24 V	DC 24 V	DC 24 V	DC 24 V
Reverse polarity protection of rated load voltage	✓	✓	✓	✓
Current consumption from load voltage L+ (without load)	-	-	-	-
Rated value	DC 24 V	DC 24 V	DC 24 V	DC 24 V
Input voltage for signal "0"	DC 0...5 V	DC 0...5 V	DC 0...5 V	DC 0...5 V
Input voltage for signal "1"	DC 15...28.8 V	DC 15...28.8 V	DC 15...28.8 V	DC 15...28.8 V
Input current for signal "1"	7 mA	7 mA	7 mA	7 mA
Connection of Two-Wire-BEROs possible	✓	✓	✓	✓
Max. permissible BERO quiescent current	1.5 mA	1.5 mA	1.5 mA	1.5 mA
Input delay of "0" to "1"	3 ms	3 ms	3 ms	3 ms
Input delay of "1" to "0"	3 ms	3 ms	3 ms	3 ms
Input characteristic curve	IEC 61131-2, type 1	IEC 61131-2, type 1	IEC 61131-2, type 1	IEC 61131-2, type 1
Initial data size	2 Byte	2 Byte	2 Byte	2 Byte
Technical data digital outputs				
Number of outputs	16	16	16	16
Cable length, shielded	1000 m	1000 m	1000 m	1000 m
Cable length, unshielded	600 m	600 m	600 m	600 m
Rated load voltage	DC 24 V	DC 24 V	DC 24 V	DC 24 V
Reverse polarity protection of rated load voltage	-	-	-	-
Current consumption from load voltage L+ (without load)	50 mA	50 mA	50 mA	50 mA
Total current per group, horizontal configuration, 40°C	4 A	4 A	4 A	4 A
Total current per group, horizontal configuration, 60°C	4 A	4 A	4 A	4 A
Total current per group, vertical configuration	4 A	4 A	4 A	4 A
Output voltage signal "1" at min. current	L+ (-125 mV)	L+ (-125 mV)	L+ (-125 mV)	L+ (-125 mV)
Output voltage signal "1" at max. current	L+ (-0.8 V)	L+ (-0.8 V)	L+ (-0.8 V)	L+ (-0.8 V)
Output current at signal "1", rated value	0.5 A	0.5 A	0.5 A	0.5 A
Output delay of "0" to "1"	max. 100 µs	max. 100 µs	max. 100 µs	max. 100 µs
Output delay of "1" to "0"	max. 350 µs	max. 350 µs	max. 350 µs	max. 350 µs
Minimum load current	-	-	-	-
Lamp load	5 W	5 W	5 W	5 W
Switching frequency with resistive load	max. 1000 Hz	max. 1000 Hz	max. 1000 Hz	max. 1000 Hz
Switching frequency with inductive load	max. 0.5 Hz	max. 0.5 Hz	max. 0.5 Hz	max. 0.5 Hz
Switching frequency on lamp load	max. 10 Hz	max. 10 Hz	max. 10 Hz	max. 10 Hz
Internal limitation of inductive shut-off voltage	L+ (-52 V)	L+ (-52 V)	L+ (-52 V)	L+ (-52 V)

Lines displays Commander compact					
603-1CC21	603-2CC22				
603-1CC22	603-2CC23				
603-1CC23					
603-2CC21					

Order number	603-1CC21	603-1CC22	603-1CC23	603-2CC21
Short-circuit protection of output	yes, electronic	yes, electronic	yes, electronic	yes, electronic
Trigger level	1 A	1 A	1 A	1 A
Output data size	2 Byte	2 Byte	2 Byte	2 Byte
Technical data counters				
Number of counters	-	-	-	-
Counter width	-	-	-	-
Maximum input frequency	-	-	-	-
Maximum count frequency	-	-	-	-
Mode incremental encoder	-	-	-	-
Mode pulse / direction	-	-	-	-
Mode pulse	-	-	-	-
Mode frequency counter	-	-	-	-
Mode period measurement	-	-	-	-
Gate input available	-	-	-	-
Latch input available	-	-	-	-
Reset input available	-	-	-	-
Counter output available	-	-	-	-
Status information, alarms, diagnostics				
Status display	yes	yes	yes	yes
Interrupts	no	no	no	no
Process alarm	yes	yes	yes	yes
Diagnostic interrupt	yes	yes	yes	yes
Diagnostic functions	no	no	no	no
Diagnostics information read-out	possible	possible	possible	possible
Supply voltage display	green LED	green LED	green LED	green LED
Group error display	red SF LED	red SF LED	red SF LED	red SF LED
Channel error display	red LED per group	red LED per group	red LED per group	red LED per group
Isolation				
Between channels of groups to	8	8	8	8
Between channels and backplane bus	✓	✓	✓	✓
Insulation tested with	DC 500 V	DC 500 V	DC 500 V	DC 500 V
Load and working memory				
Load memory, integrated	24 KB	32 KB	40 KB	24 KB
Load memory, maximum	24 KB	32 KB	40 KB	24 KB
Work memory, integrated	16 KB	24 KB	32 KB	16 KB
Work memory, maximal	16 KB	24 KB	32 KB	16 KB
Memory divided in 50% program / 50% data	-	-	-	-
Memory card slot	MMC-Card with max. 512 MB	MMC-Card with max. 512 MB	MMC-Card with max. 512 MB	MMC-Card with max. 512 MB
Hardware configuration				
Racks, max.	1	1	1	1
Modules per rack, max.	4	4	4	4
Number of integrated DP master	0	0	0	0
Number of DP master via CP	4	4	4	4
Operable function modules	4	4	4	4

SLIO
100V
200V
300S
500S
HMI
Teleservice
StarterKits
Safety
Solutions
Software
Accessories
Appendix

Lines displays Commander compact						
603-1CC21	603-2CC22					
603-1CC22	603-2CC23					
603-1CC23						
603-2CC21						

Order number	603-1CC21	603-1CC22	603-1CC23	603-2CC21
Operable communication modules PtP	4	4	4	4
Operable communication modules LAN	-	-	-	-
Command processing times				
Bit instructions, min.	0.25 µs	0.25 µs	0.25 µs	0.25 µs
Word instruction, min.	1.2 µs	1.2 µs	1.2 µs	1.2 µs
Double integer arithmetic, min.	2.6 µs	2.6 µs	2.6 µs	2.6 µs
Floating-point arithmetic, min.	50 µs	50 µs	50 µs	50 µs
Timers/Counters and their retentive characteristics				
Number of S7 counters	256	256	256	256
S7 counter remanence	adjustable 0 up to 64	adjustable 0 up to 64	adjustable 0 up to 64	adjustable 0 up to 64
S7 counter remanence adjustable	C0 .. C7	C0 .. C7	C0 .. C7	C0 .. C7
Number of S7 times	256	256	256	256
S7 times remanence	adjustable 0 up to 128	adjustable 0 up to 128	adjustable 0 up to 128	adjustable 0 up to 128
S7 times remanence adjustable	not retentive	not retentive	not retentive	not retentive
Data range and retentive characteristic				
Number of flags	8192 Bit	8192 Bit	8192 Bit	8192 Bit
Bit memories retentive characteristic adjustable	adjustable 0 up to 256	adjustable 0 up to 256	adjustable 0 up to 256	adjustable 0 up to 256
Bit memories retentive characteristic preset	MB0 .. MB15	MB0 .. MB15	MB0 .. MB15	MB0 .. MB15
Number of data blocks	2047	2047	2047	2047
Max. data blocks size	16 KB	16 KB	16 KB	16 KB
Number range DBs	1 ... 2047	1 ... 2047	1 ... 2047	1 ... 2047
Max. local data size per execution level	1024 Byte	1024 Byte	1024 Byte	1024 Byte
Max. local data size per block	1024 Byte	1024 Byte	1024 Byte	1024 Byte
Blocks				
Number of OBs	14	14	14	14
Maximum OB size	16 KB	16 KB	16 KB	16 KB
Totalnumber DBs, FBs, FCs	-	-	-	-
Number of FBs	1024	1024	1024	1024
Maximum FB size	16 KB	16 KB	16 KB	16 KB
Number range FBs	0 ... 1023	0 ... 1023	0 ... 1023	0 ... 1023
Number of FCs	1024	1024	1024	1024
Maximum FC size	16 KB	16 KB	16 KB	16 KB
Number range FC2	0 ... 1023	0 ... 1023	0 ... 1023	0 ... 1023
Maximum nesting depth per priority class	8	8	8	8
Maximum nesting depth additional within an error OB	4	4	4	4
Time				
Real-time clock buffered	✓	✓	✓	✓
Clock buffered period (min.)	30 d	30 d	30 d	30 d
Type of buffering	-	-	-	-
Load time for 50% buffering period	20 h	20 h	20 h	20 h
Load time for 100% buffering period	48 h	48 h	48 h	48 h
Accuracy (max. deviation per day)	10 s	10 s	10 s	10 s
Number of operating hours counter	8	8	8	8

Lines displays Commander compact					
603-1CC21	603-2CC22				
603-1CC22	603-2CC23				
603-1CC23					
603-2CC21					

Order number	603-1CC21	603-1CC22	603-1CC23	603-2CC21
Clock synchronization	-	-	-	-
Synchronization via MPI	no	no	no	no
Synchronization via Ethernet (NTP)	no	no	no	no
Address areas (I/O)				
Input I/O address area	1024 Bit	1024 Bit	1024 Bit	1024 Bit
Output I/O address area	1024 Bit	1024 Bit	1024 Bit	1024 Bit
Process image adjustable	-	-	-	-
Input process image preset	128 Byte	128 Byte	128 Byte	128 Byte
Output process image preset	128 Byte	128 Byte	128 Byte	128 Byte
Input process image maximal	128 Byte	128 Byte	128 Byte	128 Byte
Output process image maximal	128 Byte	128 Byte	128 Byte	128 Byte
Digital inputs	8192	8192	8192	8192
Digital outputs	8192	8192	8192	8192
Digital inputs central	144	144	144	144
Digital outputs central	144	144	144	144
Integrated digital inputs	16	16	16	16
Integrated digital outputs	16	16	16	16
Analog inputs	512	512	512	512
Analog outputs	512	512	512	512
Analog inputs, central	32	32	32	32
Analog outputs, central	16	16	16	16
Integrated analog inputs	-	-	-	-
Integrated analog outputs	-	-	-	-
Communication functions				
PG/OP channel	✓	✓	✓	✓
Global data communication	✓	✓	✓	✓
Number of GD circuits, max.	4	4	4	4
Size of GD packets, max.	22 Byte	22 Byte	22 Byte	22 Byte
S7 basic communication	✓	✓	✓	✓
S7 basic communication, user data per job	76 Byte	76 Byte	76 Byte	76 Byte
S7 communication	✓	✓	✓	✓
S7 communication as server	✓	✓	✓	✓
S7 communication as client	-	-	-	-
S7 communication, user data per job	160 Byte	160 Byte	160 Byte	160 Byte
Number of connections, max.	16	16	16	16
Functionality Sub-D interfaces				
Type	MP2I	MP2I	MP2I	MP2I
Type of interface	RS485	RS485	RS485	RS485
Connector	Sub-D, 9-pin, female	Sub-D, 9-pin, female	Sub-D, 9-pin, female	Sub-D, 9-pin, female
Electrically isolated	-	-	-	-
MPI	✓	✓	✓	✓
MP2I (MPI/RS232)	✓	✓	✓	✓
DP master	-	-	-	-
DP slave	-	-	-	-
Point-to-point interface	-	-	-	-

SLIO
100V
200V
300S
500S
HMI
Teleservice
StarterKits
Safety
Solutions
Software
Accessories
Appendix

Lines displays Commander compact					
603-1CC21	603-2CC22				
603-1CC22	603-2CC23				
603-1CC23					
603-2CC21					

Order number	603-1CC21	603-1CC22	603-1CC23	603-2CC21
Type	-	-	-	DP
Type of interface	-	-	-	RS485
Connector	-	-	-	Sub-D, 9-pin, female
Electrically isolated	-	-	-	✓
MPI	-	-	-	-
MP ² I (MPI/RS232)	-	-	-	-
DP master	-	-	-	-
DP slave	-	-	-	yes
Point-to-point interface	-	-	-	-
Functionality MPI				
Number of connections, max.	16	16	16	16
PG/OP channel	✓	✓	✓	✓
Routing	-	-	-	-
Global data communication	✓	✓	✓	✓
S7 basic communication	✓	✓	✓	✓
S7 communication	✓	✓	✓	✓
S7 communication as server	✓	✓	✓	✓
S7 communication as client	-	-	-	-
Transmission speed, min.	19.2 kbit/s	19.2 kbit/s	19.2 kbit/s	19.2 kbit/s
Transmission speed, max.	187.5 kbit/s	187.5 kbit/s	187.5 kbit/s	187.5 kbit/s
Functionality PROFIBUS slave				
PG/OP channel	-	-	-	-
Routing	-	-	-	-
S7 communication	-	-	-	-
S7 communication as server	-	-	-	-
S7 communication as client	-	-	-	-
Direct data exchange (slave-to-slave communication)	-	-	-	-
DPV1	-	-	-	-
Transmission speed, min.	-	-	-	9.6 kbit/s
Transmission speed, max.	-	-	-	12 Mbit/s
Automatic detection of transmission speed	-	-	-	✓
Transfer memory inputs, max.	-	-	-	64 Byte
Transfer memory outputs, max.	-	-	-	64 Byte
Address areas, max.	-	-	-	-
User data per address area, max.	-	-	-	-
Mechanical data				
Housing / Protection type				
Material	die-cast aluminum	die-cast aluminum	die-cast aluminum	die-cast aluminum
Mounting	via integrated pivoted lever	via integrated pivoted lever	via integrated pivoted lever	via integrated pivoted lever
Protect type front side	IP 65	IP 65	IP 65	IP 65
Protect type back side	IP 20	IP 20	IP 20	IP 20

SLIO
100V
200V
300S
500S
HMI
Teleservice
StarterKits
Safety
Solutions
Software
Accessories
Appendix

Lines displays Commander compact						
603-1CC21	603-2CC22					
603-1CC22	603-2CC23					
603-1CC23						
603-2CC21						

Order number	603-1CC21	603-1CC22	603-1CC23	603-2CC21
Dimensions				
Front panel	187 mm x 90 mm x 6 mm	187 mm x 90 mm x 6 mm	187 mm x 90 mm x 6 mm	187 mm x 90 mm x 6 mm
Rear panel	154 mm x 77 mm x 55 mm	154 mm x 77 mm x 55 mm	154 mm x 77 mm x 55 mm	154 mm x 77 mm x 55 mm
Installation cut-out				
Width	156 mm	156 mm	156 mm	156 mm
Height	78 mm	78 mm	78 mm	78 mm
Minimum	2.5 mm	2.5 mm	2.5 mm	2.5 mm
Maximum front panel thickness	6 mm	6 mm	6 mm	6 mm
Weight	580 g	580 g	580 g	600 g
Environmental conditions				
Operating temperature	0 °C to 60 °C	0 °C to 60 °C	0 °C to 60 °C	0 °C to 60 °C
Storage temperature	-20 °C to 70 °C	-20 °C to 70 °C	-20 °C to 70 °C	-20 °C to 70 °C
Certifications				
UL508 certification	yes	yes	yes	yes

- SLIO
- 100V
- 200V
- 300S
- 500S
- HMI
- Teleservice
- StarterKits
- Safety
- Solutions
- Software
- Accessories
- Appendix

Connections, Interfaces

Lines displays | Commander compact

603-1CC21	603-2CC22				
603-1CC22	603-2CC23				
603-1CC23					
603-2CC21					

603-1CC21

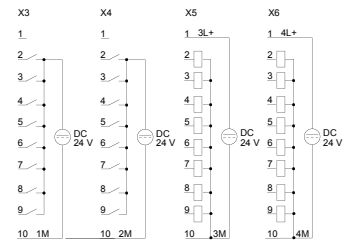
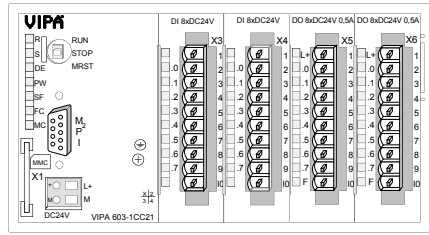
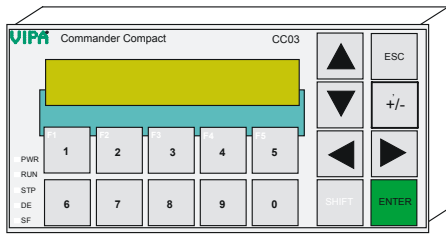

① 9-pin SubD connector, female (System bus extension)

603-1CC22

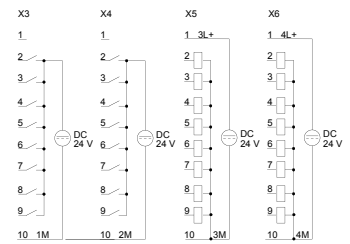
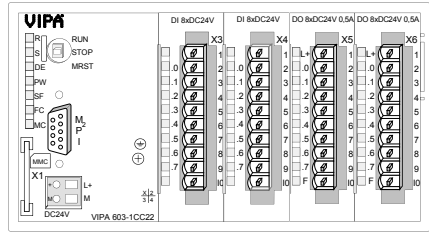
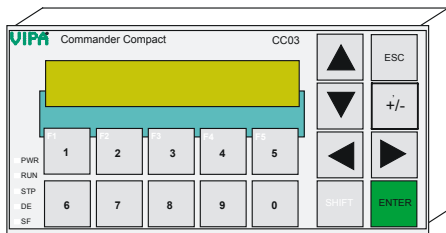

① 9-pin SubD connector, female (System bus extension)

603-1CC23

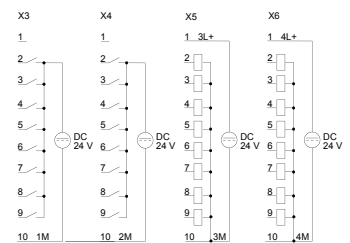
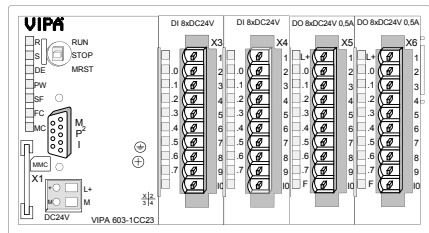
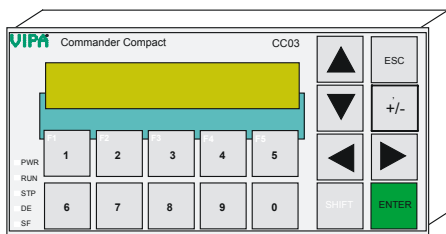

① 9-pin SubD connector, female (System bus extension)

603-2CC21

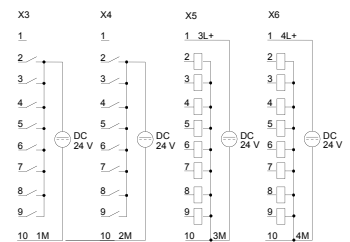
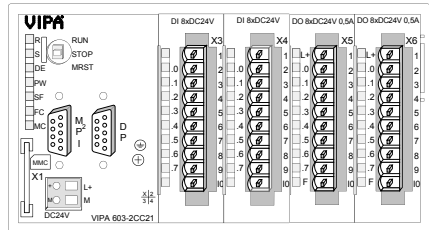
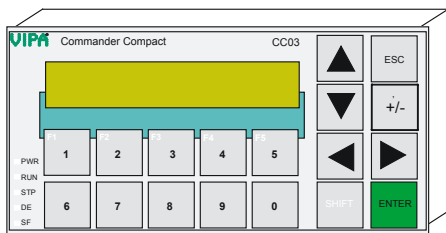



① 9-pin SubD connector, female (System bus extension)

SLIO
100V
200V
300S
500S
HMI
Teleservice
StarterKits
Safety
Solutions
Software
Accessories
Appendix
584

Commander compact

Lines displays Commander compact					
603-1CC21	603-2CC22				
603-1CC22	603-2CC23				
603-1CC23					
603-2CC21					

Order number	603-2CC22	603-2CC23		
Figure				
Type	CC 03DP, Commander Compact, PROFIBUS-DP slave	CC 03DP, Commander Compact, PROFIBUS-DP slave		
General information				
Note	-	-		
Features	<ul style="list-style-type: none"> ▸ Display: 2 x 20 characters ▸ Interface: MP²I, PROFIBUS-DP slave ▸ User memory: 128 kB ▸ Languages: DE, EN, FR, ES, IT, SV, NO, DA ▸ Project engineering via VIPA OP-Manager or Siemens ProTool ▸ Integrated PLC-CPU: 24/32kByte work/load memory, 16 x DI, 16 x DO, up to 4 I/O expansion modules 	<ul style="list-style-type: none"> ▸ Display: 2 x 20 characters ▸ Interface: MP²I, PROFIBUS-DP slave ▸ User memory: 128 kB ▸ Languages: DE, EN, FR, ES, IT, SV, NO, DA ▸ Project engineering via VIPA OP-Manager or Siemens ProTool ▸ Integrated PLC-CPU: 32/40kByte work/load memory, 16 x DI, 16 x DO, up to 4 I/O expansion modules 		
Display				
Number of rows	2	2		
Characters per row	20	20		
Character height	5 mm	5 mm		
Type of display	STN with LED back-lighting	STN with LED back-lighting		
OP functionality				
User memory	128 KB	128 KB		
Number of variables	4096	4096		
Language	DE/EN/FR/ES/IT/SV/NO/DA	DE/EN/FR/ES/IT/SV/NO/DA		
Operating controls				
Touchscreen	-	-		
Mouse	-	-		
Number of system keys	8	8		
Number of soft keys	5	5		
Technical data power supply				
Power supply (rated value)	DC 24 V	DC 24 V		
Power supply (permitted range)	DC 20.4...28.8 V	DC 20.4...28.8 V		
Reverse polarity protection	✓	✓		
Current consumption (no-load operation)	150 mA	150 mA		
Current consumption (rated value)	1 A	1 A		
Inrush current	60 A	60 A		
I _{Δt}	0.35 A ² s	0.35 A ² s		
Max. current drain at backplane bus	0.8 A	0.8 A		
Power loss	8 W	8 W		

Lines displays Commander compact					
603-1CC21	603-2CC22				
603-1CC22	603-2CC23				
603-1CC23					
603-2CC21					

Order number	603-2CC22	603-2CC23		
Reverse polarity protection	✓	✓		
Technical data digital inputs				
Number of inputs	16	16		
Cable length, shielded	1000 m	1000 m		
Cable length, unshielded	600 m	600 m		
Rated load voltage	DC 24 V	DC 24 V		
Reverse polarity protection of rated load voltage	✓	✓		
Current consumption from load voltage L+ (without load)	-	-		
Rated value	DC 24 V	DC 24 V		
Input voltage for signal "0"	DC 0...5 V	DC 0...5 V		
Input voltage for signal "1"	DC 15...28.8 V	DC 15...28.8 V		
Input current for signal "1"	7 mA	7 mA		
Connection of Two-Wire-BEROs possible	✓	✓		
Max. permissible BERO quiescent current	1.5 mA	1.5 mA		
Input delay of "0" to "1"	3 ms	3 ms		
Input delay of "1" to "0"	3 ms	3 ms		
Input characteristic curve	IEC 61131-2, type 1	IEC 61131-2, type 1		
Initial data size	2 Byte	2 Byte		
Technical data digital outputs				
Number of outputs	16	16		
Cable length, shielded	1000 m	1000 m		
Cable length, unshielded	600 m	600 m		
Rated load voltage	DC 24 V	DC 24 V		
Reverse polarity protection of rated load voltage	-	-		
Current consumption from load voltage L+ (without load)	50 mA	50 mA		
Total current per group, horizontal configuration, 40°C	4 A	4 A		
Total current per group, horizontal configuration, 60°C	4 A	4 A		
Total current per group, vertical configuration	4 A	4 A		
Output voltage signal "1" at min. current	L+ (-125 mV)	L+ (-125 mV)		
Output voltage signal "1" at max. current	L+ (-0.8 V)	L+ (-0.8 V)		
Output current at signal "1", rated value	0.5 A	0.5 A		
Output delay of "0" to "1"	max. 100 µs	max. 100 µs		
Output delay of "1" to "0"	max. 350 µs	max. 350 µs		
Minimum load current	-	-		
Lamp load	5 W	5 W		
Switching frequency with resistive load	max. 1000 Hz	max. 1000 Hz		
Switching frequency with inductive load	max. 0.5 Hz	max. 0.5 Hz		
Switching frequency on lamp load	max. 10 Hz	max. 10 Hz		
Internal limitation of inductive shut-off voltage	L+ (-52 V)	L+ (-52 V)		

Lines displays Commander compact					
603-1CC21	603-2CC22				
603-1CC22	603-2CC23				
603-1CC23					
603-2CC21					

Order number	603-2CC22	603-2CC23		
Short-circuit protection of output	yes, electronic	yes, electronic		
Trigger level	1 A	1 A		
Output data size	2 Byte	2 Byte		
Technical data counters				
Number of counters	-	-		
Counter width	-	-		
Maximum input frequency	-	-		
Maximum count frequency	-	-		
Mode incremental encoder	-	-		
Mode pulse / direction	-	-		
Mode pulse	-	-		
Mode frequency counter	-	-		
Mode period measurement	-	-		
Gate input available	-	-		
Latch input available	-	-		
Reset input available	-	-		
Counter output available	-	-		
Status information, alarms, diagnostics				
Status display	yes	yes		
Interrupts	no	no		
Process alarm	yes	yes		
Diagnostic interrupt	yes	yes		
Diagnostic functions	no	no		
Diagnostics information read-out	possible	possible		
Supply voltage display	green LED	green LED		
Group error display	red SF LED	red SF LED		
Channel error display	red LED per group	red LED per group		
Isolation				
Between channels of groups to	8	8		
Between channels and backplane bus	✓	✓		
Insulation tested with	DC 500 V	DC 500 V		
Load and working memory				
Load memory, integrated	32 KB	40 KB		
Load memory, maximum	32 KB	40 KB		
Work memory, integrated	24 KB	32 KB		
Work memory, maximal	24 KB	32 KB		
Memory divided in 50% program / 50% data	-	-		
Memory card slot	MMC-Card with max. 512 MB	MMC-Card with max. 512 MB		
Hardware configuration				
Racks, max.	1	1		
Modules per rack, max.	4	4		
Number of integrated DP master	0	0		
Number of DP master via CP	4	4		
Operable function modules	4	4		

Lines displays Commander compact					
603-1CC21	603-2CC22				
603-1CC22	603-2CC23				
603-1CC23					
603-2CC21					

Order number	603-2CC22	603-2CC23		
Operable communication modules PtP	4	4		
Operable communication modules LAN	-	-		
Command processing times				
Bit instructions, min.	0.25 µs	0.25 µs		
Word instruction, min.	1.2 µs	1.2 µs		
Double integer arithmetic, min.	2.6 µs	2.6 µs		
Floating-point arithmetic, min.	50 µs	50 µs		
Timers/Counters and their retentive characteristics				
Number of S7 counters	256	256		
S7 counter remanence	adjustable 0 up to 64	adjustable 0 up to 64		
S7 counter remanence adjustable	C0 .. C7	C0 .. C7		
Number of S7 times	256	256		
S7 times remanence	adjustable 0 up to 128	adjustable 0 up to 128		
S7 times remanence adjustable	not retentive	not retentive		
Data range and retentive characteristic				
Number of flags	8192 Bit	8192 Bit		
Bit memories retentive characteristic adjustable	adjustable 0 up to 256	adjustable 0 up to 256		
Bit memories retentive characteristic preset	MB0 .. MB15	MB0 .. MB15		
Number of data blocks	2047	2047		
Max. data blocks size	16 KB	16 KB		
Number range DBs	1 ... 2047	1 ... 2047		
Max. local data size per execution level	1024 Byte	1024 Byte		
Max. local data size per block	1024 Byte	1024 Byte		
Blocks				
Number of OBs	14	14		
Maximum OB size	16 KB	16 KB		
Totalnumber DBs, FBs, FCs	-	-		
Number of FBs	1024	1024		
Maximum FB size	16 KB	16 KB		
Number range FBs	0 ... 1023	0 ... 1023		
Number of FCs	1024	1024		
Maximum FC size	16 KB	16 KB		
Number range FC2	0 ... 1023	0 ... 1023		
Maximum nesting depth per priority class	8	8		
Maximum nesting depth additional within an error OB	4	4		
Time				
Real-time clock buffered	✓	✓		
Clock buffered period (min.)	30 d	30 d		
Type of buffering	-	-		
Load time for 50% buffering period	20 h	20 h		
Load time for 100% buffering period	48 h	48 h		
Accuracy (max. deviation per day)	10 s	10 s		
Number of operating hours counter	8	8		

Lines displays Commander compact					
603-1CC21	603-2CC22				
603-1CC22	603-2CC23				
603-1CC23					
603-2CC21					

Order number	603-2CC22	603-2CC23		
Clock synchronization	-	-		
Synchronization via MPI	no	no		
Synchronization via Ethernet (NTP)	no	no		
Address areas (I/O)				
Input I/O address area	1024 Bit	1024 Bit		
Output I/O address area	1024 Bit	1024 Bit		
Process image adjustable	-	-		
Input process image preset	128 Byte	128 Byte		
Output process image preset	128 Byte	128 Byte		
Input process image maximal	128 Byte	128 Byte		
Output process image maximal	128 Byte	128 Byte		
Digital inputs	8192	8192		
Digital outputs	8192	8192		
Digital inputs central	144	144		
Digital outputs central	144	144		
Integrated digital inputs	16	16		
Integrated digital outputs	16	16		
Analog inputs	512	512		
Analog outputs	512	512		
Analog inputs, central	32	32		
Analog outputs, central	16	16		
Integrated analog inputs	-	-		
Integrated analog outputs	-	-		
Communication functions				
PG/OP channel	✓	✓		
Global data communication	✓	✓		
Number of GD circuits, max.	4	4		
Size of GD packets, max.	22 Byte	22 Byte		
S7 basic communication	✓	✓		
S7 basic communication, user data per job	76 Byte	76 Byte		
S7 communication	✓	✓		
S7 communication as server	✓	✓		
S7 communication as client	-	-		
S7 communication, user data per job	160 Byte	160 Byte		
Number of connections, max.	16	16		
Functionality Sub-D interfaces				
Type	MP2I	MP2I		
Type of interface	RS485	RS485		
Connector	Sub-D, 9-pin, female	Sub-D, 9-pin, female		
Electrically isolated	-	-		
MPI	✓	✓		
MP2I (MPI/RS232)	✓	✓		
DP master	-	-		
DP slave	-	-		
Point-to-point interface	-	-		

Lines displays Commander compact					
603-1CC21	603-2CC22				
603-1CC22	603-2CC23				
603-1CC23					
603-2CC21					

Order number	603-2CC22	603-2CC23		
Type	DP	DP		
Type of interface	RS485	RS485		
Connector	Sub-D, 9-pin, female	Sub-D, 9-pin, female		
Electrically isolated	✓	✓		
MPI	-	-		
MP ² I (MPI/RS232)	-	-		
DP master	-	-		
DP slave	yes	yes		
Point-to-point interface	-	-		
Functionality MPI				
Number of connections, max.	16	16		
PG/OP channel	✓	✓		
Routing	-	-		
Global data communication	✓	✓		
S7 basic communication	✓	✓		
S7 communication	✓	✓		
S7 communication as server	✓	✓		
S7 communication as client	-	-		
Transmission speed, min.	19.2 kbit/s	19.2 kbit/s		
Transmission speed, max.	187.5 kbit/s	187.5 kbit/s		
Functionality PROFIBUS slave				
PG/OP channel	-	-		
Routing	-	-		
S7 communication	-	-		
S7 communication as server	-	-		
S7 communication as client	-	-		
Direct data exchange (slave-to-slave communication)	-	-		
DPV1	-	-		
Transmission speed, min.	9.6 kbit/s	9.6 kbit/s		
Transmission speed, max.	12 Mbit/s	12 Mbit/s		
Automatic detection of transmission speed	✓	✓		
Transfer memory inputs, max.	64 Byte	64 Byte		
Transfer memory outputs, max.	64 Byte	64 Byte		
Address areas, max.	-	-		
User data per address area, max.	-	-		

Lines displays Commander compact						
603-1CC21	603-2CC22					
603-1CC22	603-2CC23					
603-1CC23						
603-2CC21						

Order number	603-2CC22	603-2CC23		
Mechanical data				
Housing / Protection type				
Material	die-cast aluminum	die-cast aluminum		
Mounting	via integrated pivoted lever	via integrated pivoted lever		
Protect type front side	IP 65	IP 65		
Protect type back side	IP 20	IP 20		
Dimensions				
Front panel	187 mm x 90 mm x 6 mm	187 mm x 90 mm x 6 mm		
Rear panel	154 mm x 77 mm x 55 mm	154 mm x 77 mm x 55 mm		
Installation cut-out				
Width	156 mm	156 mm		
Height	78 mm	78 mm		
Minimum	2.5 mm	2.5 mm		
Maximum front panel thickness	6 mm	6 mm		
Weight	600 g	600 g		
Environmental conditions				
Operating temperature	0 °C to 60 °C	0 °C to 60 °C		
Storage temperature	-20 °C to 70 °C	-20 °C to 70 °C		
Certifications				
UL508 certification	yes	yes		

Connections, Interfaces

Lines displays | Commander compact

603-1CC21	603-2CC22				
603-1CC22	603-2CC23				
603-1CC23					
603-2CC21					

603-2CC22

① 9-pin SubD connector, female (System bus extension)

603-2CC23

① 9-pin SubD connector, female (System bus extension)

professional Panels



Structure and Function

The VIPA Touch Panel family is suited for all applications in the factory, process and building automation. Due to the aluminum die-cast housing the VIPA Touch Panels are mechanically particularly robust. With the front-side IP65 protection, these devices also survive in harsh industrial environments.

The portfolio ranges from 5.7" TFT up to 12.1" TFT color display. The compact design allows the use of VIPA Touch Panels also in confined spaces. The panels can be operated either horizontally or vertically.

Features:

- › Display size: 5,7" up to 12,1"
- › Type of display: TFT color
- › Processor: XScale 800 MHz
- › Interfaces: RS232, RS485, RS422, MPI, PROFIBUS-DP slave, Ethernet RJ45, USB-A, USB-B (depending on type of panel)
- › Memory: already integrated, also with SD, MMC and CF card expandable
- › Including VIPA PLCTOOL: (allows upload/download of programs from VIPA- and STEP7 based controls, reading of the diagnosis buffer, as well as start and stop of the connected CPUs without using a programming unit)
- › Including the operating system Windows Embedded CE 6.0 Professional and the visualization system Movicon

Visualization system Movicon:





- › Editor for vector graphics with powerful and attractive library of characters
- › Extensive I/O driver library (import of variables from the PLC possible)
- › Powerful alarm management
- › Multilingual support
- › Interference and operation data acquisition including evaluation possibility
- › Archiving of process data with trend curves
- › Extensive driver library
- › Scalability of the project of basic systems to Movicon Scada platform
- › Multilingual support
- › Save and extensive user management
- › Remote management for projecting and remote maintenance
- › Remote access via standard VNC client possible
- › Integrated Ethernet TCP/IP networking
- › Integrated AWL logic (STEP5/STEP7)
- › Also deployable in combination with many controllers of different manufacturers

Overview

Order no.	Name/Description	Page
professional Panels		
62F-FEE0-CB	Touch Panel TP 605CQ ▶ 5,7", TFT, 320x240 pixel ▶ XScale processor, 800MHz ▶ 128 MB work memory, 2.048 MB user memory ▶ MPI/PROFIBUS-DP, RS232, RS422/485, USB-A, USB-B, Ethernet RJ45 ▶ Windows Embedded CE 6.0 Professional, Movicon Runtime	596
62F-FEE0-CX	Touch Panel TP 605CQ ▶ 5,7", TFT, 320x240 pixel ▶ XScale processor, 800MHz ▶ 128 MB work memory, 2.048 MB user memory ▶ MPI/PROFIBUS-DP, RS232, RS422/485, USB-A, USB-B, Ethernet RJ45 ▶ Windows Embedded CE 6.0 Professional, without Movicon Runtime	596
62G-FEE0-CB	Touch Panel TP 606C ▶ 6,5", TFT, 640x480 pixel ▶ XScale processor, 800MHz ▶ 128 MB work memory, 2.048 MB user memory ▶ MPI/PROFIBUS-DP, RS232, RS422/485, USB-A, USB-B, Ethernet RJ45 ▶ Windows Embedded CE 6.0 Professional, Movicon Runtime	596
62G-FEE0-CX	Touch Panel TP 606C ▶ 6,5", TFT, 640x480 pixel ▶ XScale processor, 800MHz ▶ 128 MB work memory, 2.048 MB user memory ▶ MPI/PROFIBUS-DP, RS232, RS422/485, USB-A, USB-B, Ethernet RJ45 ▶ Windows Embedded CE 6.0 Professional, without Movicon Runtime	596
62I-IEE0-CB	Touch Panel TP 608C ▶ 8,4", TFT, 800x600 pixel ▶ XScale processor, 800MHz ▶ 128 MB work memory, 2.048 MB user memory ▶ MPI/PROFIBUS-DP, RS232, RS422/485, USB-A, USB-B, 2x Ethernet RJ45 ▶ Windows Embedded CE 6.0 Professional, Movicon Runtime	600
62I-IEE0-CX	Touch Panel TP 608C ▶ 8,4", TFT, 800x600 pixel ▶ XScale processor, 800MHz ▶ 128 MB work memory, 2.048 MB user memory ▶ MPI/PROFIBUS-DP, RS232, RS422/485, USB-A, USB-B, 2x Ethernet RJ45 ▶ Windows Embedded CE 6.0 Professional, without Movicon Runtime	600
62K-JEE0-CB	Touch Panel TP 610C ▶ 10,4", TFT, 800x600 pixel ▶ XScale processor, 800MHz ▶ 128 MB work memory, 2.048 MB user memory ▶ MPI/PROFIBUS-DP, RS232, RS422/485, USB-A, USB-B, 2x Ethernet RJ45 ▶ Windows Embedded CE 6.0 Professional, Movicon Runtime	600
62K-JEE0-CX	Touch Panel TP 610C ▶ 10,4", TFT, 800x600 pixel ▶ XScale processor, 800MHz ▶ 128 MB work memory, 2.048 MB user memory ▶ MPI/PROFIBUS-DP, RS232, RS422/485, USB-A, USB-B, 2x Ethernet RJ45 ▶ Windows Embedded CE 6.0 Professional, without Movicon Runtime	600
62M-JEE0-CB	Touch Panel TP 612C ▶ 12,1", TFT, 800x600 pixel ▶ XScale processor, 800MHz ▶ 128 MB work memory, 2.048 MB user memory ▶ MPI/PROFIBUS-DP, RS232, RS422/485, USB-A, USB-B, 2x Ethernet RJ45 ▶ Windows Embedded CE 6.0 Professional, Movicon Runtime	604
62M-JEE0-CX	Touch Panel TP 612C ▶ 12,1", TFT, 800x600 pixel ▶ XScale processor, 800MHz ▶ 128 MB work memory, 2.048 MB user memory ▶ MPI/PROFIBUS-DP, RS232, RS422/485, USB-A, USB-B, 2x Ethernet RJ45 ▶ Windows Embedded CE 6.0 Professional, without Movicon	604

professional Panels

professional Panels professional Panels					
62F-FEE0-CB 62F-FEE0-CX 62G-FEE0-CB 62G-FEE0-CX	62I-IEE0-CB 62I-IEE0-CX 62K-JEE0-CB 62K-JEE0-CX	62M-JEE0-CB 62M-JEE0-CX			

Order number	62F-FEE0-CB	62F-FEE0-CX	62G-FEE0-CB	62G-FEE0-CX
Figure				
Type	Touch Panel TP 605CQ	Touch Panel TP 605CQ	Touch Panel TP 606C	Touch Panel TP 606C
General information				
Note	-	-	-	-
Features	<ul style="list-style-type: none"> ▸ 5,7", TFT, 320x240 pixel ▸ XScale processor, 800MHz ▸ 128 MB work memory, 2.048 MB user memory ▸ MPI/PROFIBUS-DP, RS232, RS422/485, USB-A, USB-B, Ethernet RJ45 ▸ Windows Embedded CE 6.0 Professional, Movicon Runtime 	<ul style="list-style-type: none"> ▸ 5,7", TFT, 320x240 pixel ▸ XScale processor, 800MHz ▸ 128 MB work memory, 2.048 MB user memory ▸ MPI/PROFIBUS-DP, RS232, RS422/485, USB-A, USB-B, Ethernet RJ45 ▸ Windows Embedded CE 6.0 Professional, without Movicon Runtime 	<ul style="list-style-type: none"> ▸ 6,5", TFT, 640x480 pixel ▸ XScale processor, 800MHz ▸ 128 MB work memory, 2.048 MB user memory ▸ MPI/PROFIBUS-DP, RS232, RS422/485, USB-A, USB-B, Ethernet RJ45 ▸ Windows Embedded CE 6.0 Professional, Movicon Runtime 	<ul style="list-style-type: none"> ▸ 6,5", TFT, 640x480 pixel ▸ XScale processor, 800MHz ▸ 128 MB work memory, 2.048 MB user memory ▸ MPI/PROFIBUS-DP, RS232, RS422/485, USB-A, USB-B, Ethernet RJ45 ▸ Windows Embedded CE 6.0 Professional, without Movicon Runtime
Display				
Display size (diagonal)	5.7 "	5.7 "	6.5 "	6.5 "
Display size (width)	115.2 mm	115.2 mm	132.5 mm	132.5 mm
Display size (height)	86.4 mm	86.4 mm	99.4 mm	99.4 mm
Resolution	240 x 320 / 320 x 240	240 x 320 / 320 x 240	480 x 640 / 640 x 480	480 x 640 / 640 x 480
Aspect ratio	4:3	4:3	4:3	4:3
Type of display	TFT color (64K colors)	TFT color (64K colors)	TFT color (64K colors)	TFT color (64K colors)
MTBF Backlights (25°C)	50000 h	50000 h	50000 h	50000 h
System properties				
Processor	Xscale 800 MHz	Xscale 800 MHz	Xscale 800 MHz	Xscale 800 MHz
Operating system	Windows CE 6.0 Prof.	Windows CE 6.0 Prof.	Windows CE 6.0 Prof.	Windows CE 6.0 Prof.
User software	Movicon 11 CE Standard	-	Movicon 11 CE Standard	-
Work memory	128 MB	128 MB	128 MB	128 MB
User memory	2 GB	2 GB	2 GB	2 GB
Available memory (user data)	1800 MB	1800 MB	1800 MB	1800 MB
SD/MMC Slot	✓	✓	✓	✓
CF Card Slot Typ II	✓	✓	✓	✓
Time				
Real-time clock buffered	✓	✓	✓	✓
Clock buffered period (min.)	6 w	6 w	6 w	6 w
Type of buffering	-	-	-	-
Load time for 50% buffering period	10 h	10 h	10 h	10 h
Load time for 100% buffering period	48 h	48 h	48 h	48 h
Accuracy (max. deviation per day)	10 s	10 s	10 s	10 s

SLIO
100V
200V
300S
500S
HMI
Teleservice
StarterKits
Safety
Solutions
Software
Accessories
Appendix

professional Panels professional Panels					
62F-FEE0-CB 62F-FEE0-CX 62G-FEE0-CB 62G-FEE0-CX	62I-IEE0-CB 62I-IEE0-CX 62K-JEE0-CB 62K-JEE0-CX	62M-JEE0-CB 62M-JEE0-CX			

Order number	62F-FEE0-CB	62F-FEE0-CX	62G-FEE0-CB	62G-FEE0-CX
Operating controls				
Touchscreen	resistive	resistive	resistive	resistive
Keyboard	external via USB	external via USB	external via USB	external via USB
Mouse	external via USB	external via USB	external via USB	external via USB
Interfaces				
MPI, PROFIBUS-DP	RS485 isolated	RS485 isolated	RS485 isolated	RS485 isolated
MPI, PROFIBUS-DP connector	Sub-D, 9-pin, female	Sub-D, 9-pin, female	Sub-D, 9-pin, female	Sub-D, 9-pin, female
Serial, COM1	RS232	RS232	RS232	RS232
COM1 connector	Sub-D, 9-pin, male	Sub-D, 9-pin, male	Sub-D, 9-pin, male	Sub-D, 9-pin, male
Serial, COM2	RS422/485 isolated	RS422/485 isolated	RS422/485 isolated	RS422/485 isolated
COM2 connector	Sub-D, 9-pin, female	Sub-D, 9-pin, female	Sub-D, 9-pin, female	Sub-D, 9-pin, female
Number of USB-A interfaces	1	1	1	1
USB-A connector	USB-A (host)	USB-A (host)	USB-A (host)	USB-A (host)
Number of USB-B interfaces	1	1	1	1
USB-B connector	USB-B (device)	USB-B (device)	USB-B (device)	USB-B (device)
Number of ethernet interfaces	1	1	1	1
Ethernet	Ethernet 10/100 MBit	Ethernet 10/100 MBit	Ethernet 10/100 MBit	Ethernet 10/100 MBit
Ethernet connector	RJ45	RJ45	RJ45	RJ45
Integrated ethernet switch	-	-	-	-
Technical data power supply				
Power supply (rated value)	DC 24 V	DC 24 V	DC 24 V	DC 24 V
Power supply (permitted range)	DC 20.4...28.8 V	DC 20.4...28.8 V	DC 20.4...28.8 V	DC 20.4...28.8 V
Reverse polarity protection	✓	✓	✓	✓
Current consumption (no-load operation)	0.26 A	0.26 A	0.34 A	0.34 A
Current consumption (rated value)	0.45 A	0.45 A	0.5 A	0.5 A
Inrush current	6 A	6 A	6 A	6 A
I _{pt}	0.2 A²s	0.2 A²s	0.2 A²s	0.2 A²s
Power loss	6.2 W	6.2 W	8.2 W	8.2 W
Status information, alarms, diagnostics				
Supply voltage display	yes	yes	yes	yes
Mechanical data				
Housing / Protection type				
Material	die-cast aluminum	die-cast aluminum	die-cast aluminum	die-cast aluminum
Mounting	via integrated pivoted lever	via integrated pivoted lever	via integrated pivoted lever	via integrated pivoted lever
Protect type front side	IP 65	IP 65	IP 65	IP 65
Protect type back side	IP 20	IP 20	IP 20	IP 20

SLIO
100V
200V
300S
500S
HMI
Teleservice
StarterKits
Safety
Solutions
Software
Accessories
Appendix

professional Panels		professional Panels					
62F-FEE0-CB 62F-FEE0-CX 62G-FEE0-CB 62G-FEE0-CX	62I-IEE0-CB 62I-IEE0-CX 62K-JEE0-CB 62K-JEE0-CX	62M-JEE0-CB 62M-JEE0-CX					

Order number	62F-FEE0-CB	62F-FEE0-CX	62G-FEE0-CB	62G-FEE0-CX
Dimensions				
Front panel	212 mm x 156 mm x 7.5 mm	212 mm x 156 mm x 7.5 mm	212 mm x 156 mm x 7.5 mm	212 mm x 156 mm x 7.5 mm
Rear panel	198 mm x 142 mm x 37 mm	198 mm x 142 mm x 37 mm	198 mm x 142 mm x 37 mm	198 mm x 142 mm x 37 mm
Installation cut-out				
Width	200 mm	200 mm	200 mm	200 mm
Height	144 mm	144 mm	144 mm	144 mm
Minimum	2.5 mm	2.5 mm	2.5 mm	2.5 mm
Maximum front panel thickness	6 mm	6 mm	6 mm	6 mm
Weight	1382 g	1382 g	1614 g	1614 g
Environmental conditions				
Operating temperature	0 °C to 50 °C	0 °C to 50 °C	0 °C to 50 °C	0 °C to 50 °C
Storage temperature	-20 °C to 60 °C	-20 °C to 60 °C	-20 °C to 60 °C	-20 °C to 60 °C
Certifications				
UL508 certification	in preparation	in preparation	in preparation	in preparation

Connections, Interfaces

professional Panels | professional Panels

62F-FEE0-CB 62F-FEE0-CX 62G-FEE0-CB 62G-FEE0-CX	62I-IEE0-CB 62I-IEE0-CX 62K-JEE0-CB 62K-JEE0-CX	62M-JEE0-CB 62M-JEE0-CX			
--	--	----------------------------	--	--	--

62F-FEE0-CB

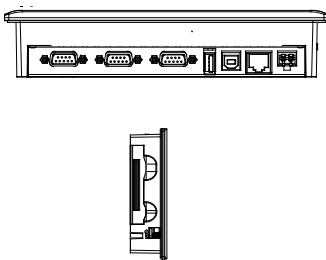

RS422/485

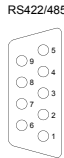

- ① n.c.
- ② n.c.
- ③ TxD
- ④ RxD
- ⑤ MSV
- ⑥ P5V
- ⑦ n.c.
- ⑧ TxD-
- ⑨ RxD-

RS232

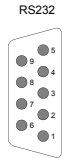

- ① CD-
- ② RxD
- ③ TxD
- ④ DTR
- ⑤ GND
- ⑥ DSR
- ⑦ RTS
- ⑧ CTS
- ⑨ RI

MPI PROFIBUS DP

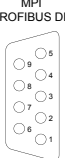

- ① n.c.
- ② M24V
- ③ RxD/TxD-P (line B)
- ④ RTS
- ⑤ MSV
- ⑥ P5V
- ⑦ P24V
- ⑧ RxD/TxD-N (line A)
- ⑨ n.c.

USB-A



- ① VCC
- ② DM
- ③ DP
- ④ GND

USB-B



- ① VCC
- ② DM
- ③ DP
- ④ GND

RJ45



- ① Tx+
- ② Tx-
- ③ -
- ④ -
- ⑤ Rx-
- ⑥ Rx+
- ⑦ -
- ⑧ -

DC 24V



- +

62F-FEE0-CX

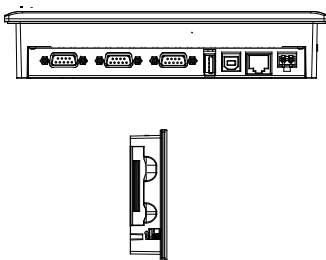

RS422/485

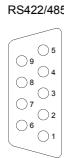

- ① n.c.
- ② n.c.
- ③ TxD
- ④ RxD
- ⑤ MSV
- ⑥ P5V
- ⑦ n.c.
- ⑧ TxD-
- ⑨ RxD-

RS232

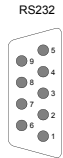

- ① CD-
- ② RxD
- ③ TxD
- ④ DTR
- ⑤ GND
- ⑥ DSR
- ⑦ RTS
- ⑧ CTS
- ⑨ RI

MPI PROFIBUS DP

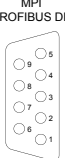

- ① n.c.
- ② M24V
- ③ RxD/TxD-P (line B)
- ④ RTS
- ⑤ MSV
- ⑥ P5V
- ⑦ P24V
- ⑧ RxD/TxD-N (line A)
- ⑨ n.c.

USB-A



- ① VCC
- ② DM
- ③ DP
- ④ GND

USB-B



- ① VCC
- ② DM
- ③ DP
- ④ GND

RJ45



- ① Tx+
- ② Tx-
- ③ -
- ④ -
- ⑤ Rx-
- ⑥ Rx+
- ⑦ -
- ⑧ -

DC 24V



- +

62G-FEE0-CB

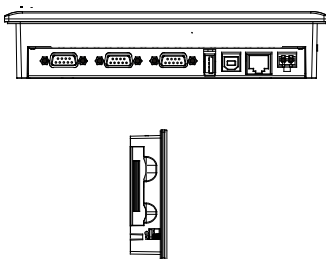

RS422/485

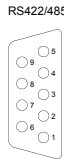

- ① n.c.
- ② n.c.
- ③ TxD
- ④ RxD
- ⑤ MSV
- ⑥ P5V
- ⑦ n.c.
- ⑧ TxD-
- ⑨ RxD-

RS232

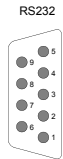

- ① CD-
- ② RxD
- ③ TxD
- ④ DTR
- ⑤ GND
- ⑥ DSR
- ⑦ RTS
- ⑧ CTS
- ⑨ RI

MPI PROFIBUS DP

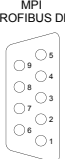

- ① n.c.
- ② M24V
- ③ RxD/TxD-P (line B)
- ④ RTS
- ⑤ MSV
- ⑥ P5V
- ⑦ P24V
- ⑧ RxD/TxD-N (line A)
- ⑨ n.c.

USB-A



- ① VCC
- ② DM
- ③ DP
- ④ GND

USB-B



- ① VCC
- ② DM
- ③ DP
- ④ GND

RJ45



- ① Tx+
- ② Tx-
- ③ -
- ④ -
- ⑤ Rx-
- ⑥ Rx+
- ⑦ -
- ⑧ -

DC 24V



- +

62G-FEE0-CX

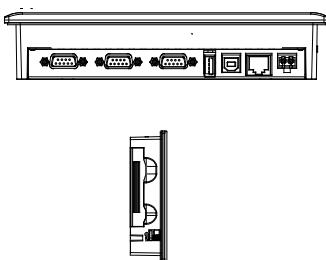

RS422/485

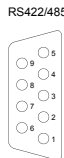

- ① n.c.
- ② n.c.
- ③ TxD
- ④ RxD
- ⑤ MSV
- ⑥ P5V
- ⑦ n.c.
- ⑧ TxD-
- ⑨ RxD-

RS232

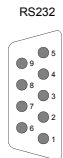

- ① CD-
- ② RxD
- ③ TxD
- ④ DTR
- ⑤ GND
- ⑥ DSR
- ⑦ RTS
- ⑧ CTS
- ⑨ RI

MPI PROFIBUS DP

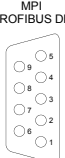

- ① n.c.
- ② M24V
- ③ RxD/TxD-P (line B)
- ④ RTS
- ⑤ MSV
- ⑥ P5V
- ⑦ P24V
- ⑧ RxD/TxD-N (line A)
- ⑨ n.c.

USB-A



- ① VCC
- ② DM
- ③ DP
- ④ GND

USB-B



- ① VCC
- ② DM
- ③ DP
- ④ GND

RJ45



- ① Tx+
- ② Tx-
- ③ -
- ④ -
- ⑤ Rx-
- ⑥ Rx+
- ⑦ -
- ⑧ -





DC 24V



- +

professional Panels

professional Panels professional Panels					
62F-FEE0-CB 62F-FEE0-CX 62G-FEE0-CB 62G-FEE0-CX	62I-IEE0-CB 62I-IEE0-CX 62K-JEE0-CB 62K-JEE0-CX	62M-JEE0-CB 62M-JEE0-CX			

Order number	62I-IEE0-CB	62I-IEE0-CX	62K-JEE0-CB	62K-JEE0-CX
Figure				
Type	Touch Panel TP 608C	Touch Panel TP 608C	Touch Panel TP 610C	Touch Panel TP 610C
General information				
Note	-	-	-	-
Features	<ul style="list-style-type: none"> 8,4", TFT, 800x600 pixel XScale processor, 800MHz 128 MB work memory, 2.048 MB user memory MPI/PROFIBUS-DP, RS232, RS422/485, USB-A, USB-B, 2x Ethernet RJ45 Windows Embedded CE 6.0 Professional, Movicon Runtime 	<ul style="list-style-type: none"> 8,4", TFT, 800x600 pixel XScale processor, 800MHz 128 MB work memory, 2.048 MB user memory MPI/PROFIBUS-DP, RS232, RS422/485, USB-A, USB-B, 2x Ethernet RJ45 Windows Embedded CE 6.0 Professional, without Movicon Runtime 	<ul style="list-style-type: none"> 10,4", TFT, 800x600 pixel XScale processor, 800MHz 128 MB work memory, 2.048 MB user memory MPI/PROFIBUS-DP, RS232, RS422/485, USB-A, USB-B, 2x Ethernet RJ45 Windows Embedded CE 6.0 Professional, Movicon Runtime 	<ul style="list-style-type: none"> 10,4", TFT, 800x600 pixel XScale processor, 800MHz 128 MB work memory, 2.048 MB user memory MPI/PROFIBUS-DP, RS232, RS422/485, USB-A, USB-B, 2x Ethernet RJ45 Windows Embedded CE 6.0 Professional, without Movicon Runtime
Display				
Display size (diagonal)	8.4 "	8.4 "	10.4 "	10.4 "
Display size (width)	170.4 mm	170.4 mm	211.2 mm	211.2 mm
Display size (height)	127.8 mm	127.8 mm	158.4 mm	158.4 mm
Resolution	600 x 800 / 800 x 600	600 x 800 / 800 x 600	600 x 800 / 800 x 600	600 x 800 / 800 x 600
Aspect ratio	4:3	4:3	4:3	4:3
Type of display	TFT color (64K colors)	TFT color (64K colors)	TFT color (64K colors)	TFT color (64K colors)
MTBF Backlights (25°C)	50000 h	50000 h	50000 h	50000 h
System properties				
Processor	Xscale 800 MHz	Xscale 800 MHz	Xscale 800 MHz	Xscale 800 MHz
Operating system	Windows CE 6.0 Prof.	Windows CE 6.0 Prof.	Windows CE 6.0 Prof.	Windows CE 6.0 Prof.
User software	Movicon 11 CE Standard	-	Movicon 11 CE Standard	-
Work memory	128 MB	128 MB	128 MB	128 MB
User memory	2 GB	2 GB	2 GB	2 GB
Available memory (user data)	1800 MB	1800 MB	1800 MB	1800 MB
SD/MMC Slot	✓	✓	✓	✓
CF Card Slot Typ II	✓	✓	✓	✓
Time				
Real-time clock buffered	✓	✓	✓	✓
Clock buffered period (min.)	6 w	6 w	6 w	6 w
Type of buffering	-	-	-	-
Load time for 50% buffering period	10 h	10 h	10 h	10 h
Load time for 100% buffering period	48 h	48 h	48 h	48 h
Accuracy (max. deviation per day)	10 s	10 s	10 s	10 s

professional Panels professional Panels					
62F-FEE0-CB 62F-FEE0-CX 62G-FEE0-CB 62G-FEE0-CX	62I-IEE0-CB 62I-IEE0-CX 62K-JEE0-CB 62K-JEE0-CX	62M-JEE0-CB 62M-JEE0-CX			

Order number	62I-IEE0-CB	62I-IEE0-CX	62K-JEE0-CB	62K-JEE0-CX
Operating controls				
Touchscreen	resistive	resistive	resistive	resistive
Keyboard	external via USB	external via USB	external via USB	external via USB
Mouse	external via USB	external via USB	external via USB	external via USB
Interfaces				
MPI, PROFIBUS-DP	RS485 isolated	RS485 isolated	RS485 isolated	RS485 isolated
MPI, PROFIBUS-DP connector	Sub-D, 9-pin, female	Sub-D, 9-pin, female	Sub-D, 9-pin, female	Sub-D, 9-pin, female
Serial, COM1	RS232	RS232	RS232	RS232
COM1 connector	Sub-D, 9-pin, male	Sub-D, 9-pin, male	Sub-D, 9-pin, male	Sub-D, 9-pin, male
Serial, COM2	RS422/485 isolated	RS422/485 isolated	RS422/485 isolated	RS422/485 isolated
COM2 connector	Sub-D, 9-pin, female	Sub-D, 9-pin, female	Sub-D, 9-pin, female	Sub-D, 9-pin, female
Number of USB-A interfaces	1	1	2	2
USB-A connector	USB-A (host)	USB-A (host)	USB-A (host)	USB-A (host)
Number of USB-B interfaces	1	1	1	1
USB-B connector	USB-B (device)	USB-B (device)	USB-B (device)	USB-B (device)
Number of ethernet interfaces	2	2	2	2
Ethernet	Ethernet 10/100 MBit	Ethernet 10/100 MBit	Ethernet 10/100 MBit	Ethernet 10/100 MBit
Ethernet connector	RJ45	RJ45	RJ45	RJ45
Integrated ethernet switch	✓	✓	✓	✓
Technical data power supply				
Power supply (rated value)	DC 24 V	DC 24 V	DC 24 V	DC 24 V
Power supply (permitted range)	DC 20.4...28.8 V	DC 20.4...28.8 V	DC 20.4...28.8 V	DC 20.4...28.8 V
Reverse polarity protection	✓	✓	✓	✓
Current consumption (no-load operation)	0.4 A	0.4 A	0.51 A	0.51 A
Current consumption (rated value)	0.6 A	0.6 A	0.7 A	0.7 A
Inrush current	7 A	7 A	7 A	7 A
I _{∫t}	0.25 A²s	0.25 A²s	0.25 A²s	0.25 A²s
Power loss	9.6 W	9.6 W	12.2 W	12.2 W
Status information, alarms, diagnostics				
Supply voltage display	yes	yes	yes	yes
Mechanical data				
Housing / Protection type				
Material	die-cast aluminum	die-cast aluminum	die-cast aluminum	die-cast aluminum
Mounting	via integrated pivoted lever	via integrated pivoted lever	via integrated pivoted lever	via integrated pivoted lever
Protect type front side	IP 65	IP 65	IP 65	IP 65
Protect type back side	IP 20	IP 20	IP 20	IP 20

professional Panels		professional Panels			
62F-FEE0-CB 62F-FEE0-CX 62G-FEE0-CB 62G-FEE0-CX	62I-IEE0-CB 62I-IEE0-CX 62K-JEE0-CB 62K-JEE0-CX	62M-JEE0-CB 62M-JEE0-CX			

Order number	62I-IEE0-CB	62I-IEE0-CX	62K-JEE0-CB	62K-JEE0-CX
Dimensions				
Front panel	264 mm x 189 mm x 7.5 mm	264 mm x 189 mm x 7.5 mm	304 mm x 233 mm x 7.5 mm	304 mm x 233 mm x 7.5 mm
Rear panel	248 mm x 173 mm x 43 mm	248 mm x 173 mm x 43 mm	285 mm x 215 mm x 45 mm	285 mm x 215 mm x 45 mm
Installation cut-out				
Width	250 mm	250 mm	287 mm	287 mm
Height	175 mm	175 mm	217 mm	217 mm
Minimum	1.5 mm	1.5 mm	1.5 mm	1.5 mm
Maximum front panel thickness	6 mm	6 mm	6 mm	6 mm
Weight	2325 g	2325 g	3251 g	3251 g
Environmental conditions				
Operating temperature	0 °C to 50 °C	0 °C to 50 °C	0 °C to 50 °C	0 °C to 50 °C
Storage temperature	-20 °C to 60 °C	-20 °C to 60 °C	-20 °C to 60 °C	-20 °C to 60 °C
Certifications				
UL508 certification	in preparation	in preparation	in preparation	in preparation

Connections, Interfaces

professional Panels | professional Panels

62F-FEE0-CB 62F-FEE0-CX 62G-FEE0-CB 62G-FEE0-CX	62I-IEE0-CB 62I-IEE0-CX 62K-JEE0-CB 62K-JEE0-CX	62M-JEE0-CB 62M-JEE0-CX			
--	--	----------------------------	--	--	--

62I-IEE0-CB

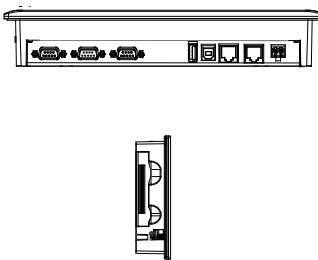

RS422/485

①	n.c.
②	n.c.
③	TxD
④	RxD
⑤	MSV
⑥	P5V
⑦	n.c.
⑧	TxD-
⑨	RxD-

RS232

①	CD-
②	RxD
③	TxD
④	DTR
⑤	GND
⑥	DSR
⑦	RTS
⑧	CTS
⑨	RI

MPI PROFIBUS DP

①	n.c.
②	M24V
③	RxD/TxD-P (line B)
④	RTS
⑤	M5V
⑥	P5V
⑦	P24V
⑧	RxD/TxD-N (line A)
⑨	n.c.

USB-A

①	VCC
②	DM
③	DP
④	GND

USB-B

①	VCC
②	DM
③	DP
④	GND

RJ45 2x

①	Tx+
②	Tx-
③	-
④	Rx+
⑤	-
⑥	Rx-
⑦	-
⑧	-

DC 24V

-	-	+
---	---	---

62I-IEE0-CX

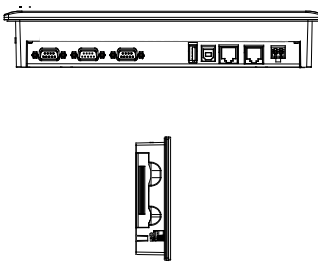

RS422/485

①	n.c.
②	n.c.
③	TxD
④	RxD
⑤	MSV
⑥	P5V
⑦	n.c.
⑧	TxD-
⑨	RxD-

RS232

①	CD-
②	RxD
③	TxD
④	DTR
⑤	GND
⑥	DSR
⑦	RTS
⑧	CTS
⑨	RI

MPI PROFIBUS DP

①	n.c.
②	M24V
③	RxD/TxD-P (line B)
④	RTS
⑤	M5V
⑥	P5V
⑦	P24V
⑧	RxD/TxD-N (line A)
⑨	n.c.

USB-A

①	VCC
②	DM
③	DP
④	GND

USB-B

①	VCC
②	DM
③	DP
④	GND

RJ45 2x

①	Tx+
②	Tx-
③	Rx+
④	-
⑤	Rx-
⑥	-
⑦	-
⑧	-

DC 24V

-	-	+
---	---	---

62K-JEE0-CB

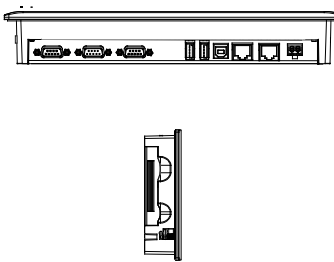

RS422/485

①	n.c.
②	n.c.
③	TxD
④	RxD
⑤	MSV
⑥	P5V
⑦	n.c.
⑧	TxD-
⑨	RxD-

RS232

①	CD-
②	RxD
③	TxD
④	DTR
⑤	GND
⑥	DSR
⑦	RTS
⑧	CTS
⑨	RI

MPI PROFIBUS DP

①	n.c.
②	M24V
③	RxD/TxD-P (line B)
④	RTS
⑤	M5V
⑥	P5V
⑦	P24V
⑧	RxD/TxD-N (line A)
⑨	n.c.

USB-A 2x

①	VCC
②	DM
③	DP
④	GND

USB-B

①	VCC
②	DM
③	DP
④	GND

RJ45 2x

①	Tx+
②	Tx-
③	Rx+
④	-
⑤	Rx-
⑥	-
⑦	-
⑧	-

DC 24V

-	-	+
---	---	---

62K-JEE0-CX

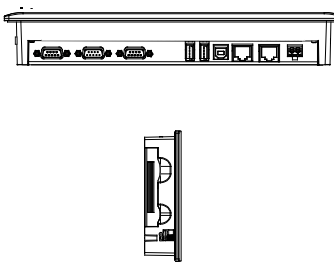

RS422/485

①	n.c.
②	n.c.
③	TxD
④	RxD
⑤	MSV
⑥	P5V
⑦	n.c.
⑧	TxD-
⑨	RxD-

RS232

①	CD-
②	RxD
③	TxD
④	DTR
⑤	GND
⑥	DSR
⑦	RTS
⑧	CTS
⑨	RI

MPI PROFIBUS DP

①	n.c.
②	M24V
③	RxD/TxD-P (line B)
④	RTS
⑤	M5V
⑥	P5V
⑦	P24V
⑧	RxD/TxD-N (line A)
⑨	n.c.

USB-A 2x

①	VCC
②	DM
③	DP
④	GND

USB-B

①	VCC
②	DM
③	DP
④	GND

RJ45 2x



①	Tx+
②	Tx-
③	Rx+
④	-
⑤	Rx-
⑥	-
⑦	-
⑧	-

DC 24V

-	-	+
---	---	---

professional Panels

professional Panels professional Panels		62M-JEE0-CB				
62F-FEE0-CB 62F-FEE0-CX 62G-FEE0-CB 62G-FEE0-CX	62I-IEE0-CB 62I-IEE0-CX 62K-JEE0-CB 62K-JEE0-CX	62M-JEE0-CB 62M-JEE0-CX				

Order number	62M-JEE0-CB	62M-JEE0-CX		
Figure				
Type	Touch Panel TP 612C	Touch Panel TP 612C		
General information				
Note	-	-		
Features	<ul style="list-style-type: none"> ▶ 12,1", TFT, 800x600 pixel ▶ XScale processor, 800MHz ▶ 128 MB work memory, 2.048 MB user memory ▶ MPI/PROFIBUS-DP, RS232, RS422/485, USB-A, USB-B, 2x Ethernet RJ45 ▶ Windows Embedded CE 6.0 Professional, Movicon Runtime 	<ul style="list-style-type: none"> ▶ 12,1", TFT, 800x600 pixel ▶ XScale processor, 800MHz ▶ 128 MB work memory, 2.048 MB user memory ▶ MPI/PROFIBUS-DP, RS232, RS422/485, USB-A, USB-B, 2x Ethernet RJ45 ▶ Windows Embedded CE 6.0 Professional, without Movicon 		
Display				
Display size (diagonal)	12.1 "	12.1 "		
Display size (width)	246 mm	246 mm		
Display size (height)	184.5 mm	184.5 mm		
Resolution	600 x 800 / 800 x 600	600 x 800 / 800 x 600		
Aspect ratio	4:3	4:3		
Type of display	TFT color (64K colors)	TFT color (64K colors)		
MTBF Backlights (25°C)	50000 h	50000 h		
System properties				
Processor	Xscale 800 MHz	Xscale 800 MHz		
Operating system	Windows CE 6.0 Prof.	Windows CE 6.0 Prof.		
User software	Movicon 11 CE Standard	-		
Work memory	128 MB	128 MB		
User memory	2 GB	2 GB		
Available memory (user data)	1800 MB	1800 MB		
SD/MMC Slot	✓	✓		
CF Card Slot Typ II	✓	✓		
Time				
Real-time clock buffered	✓	✓		
Clock buffered period (min.)	6 w	6 w		
Type of buffering	-	-		
Load time for 50% buffering period	10 h	10 h		
Load time for 100% buffering period	48 h	48 h		
Accuracy (max. deviation per day)	10 s	10 s		

SLIO
100V
200V
300S
500S
HMI
Teleservice
StarterKits
Safety
Solutions
Software
Accessories
Appendix

professional Panels professional Panels					
62F-FEE0-CB 62F-FEE0-CX 62G-FEE0-CB 62G-FEE0-CX	62I-IEE0-CB 62I-IEE0-CX 62K-JEE0-CB 62K-JEE0-CX	62M-JEE0-CB 62M-JEE0-CX			

Order number	62M-JEE0-CB	62M-JEE0-CX		
Operating controls				
Touchscreen	resistive	resistive		
Keyboard	external via USB	external via USB		
Mouse	external via USB	external via USB		
Interfaces				
MPI, PROFIBUS-DP	RS485 isolated	RS485 isolated		
MPI, PROFIBUS-DP connector	Sub-D, 9-pin, female	Sub-D, 9-pin, female		
Serial, COM1	RS232	RS232		
COM1 connector	Sub-D, 9-pin, male	Sub-D, 9-pin, male		
Serial, COM2	RS422/485 isolated	RS422/485 isolated		
COM2 connector	Sub-D, 9-pin, female	Sub-D, 9-pin, female		
Number of USB-A interfaces	2	2		
USB-A connector	USB-A (host)	USB-A (host)		
Number of USB-B interfaces	1	1		
USB-B connector	USB-B (device)	USB-B (device)		
Number of ethernet interfaces	2	2		
Ethernet	Ethernet 10/100 MBit	Ethernet 10/100 MBit		
Ethernet connector	RJ45	RJ45		
Integrated ethernet switch	✓	✓		
Technical data power supply				
Power supply (rated value)	DC 24 V	DC 24 V		
Power supply (permitted range)	DC 20.4...28.8 V	DC 20.4...28.8 V		
Reverse polarity protection	✓	✓		
Current consumption (no-load operation)	0.66 A	0.66 A		
Current consumption (rated value)	0.8 A	0.8 A		
Inrush current	7 A	7 A		
I _{∫t}	0.25 A²s	0.25 A²s		
Power loss	15.8 W	15.8 W		
Status information, alarms, diagnostics				
Supply voltage display	yes	yes		
Mechanical data				
Housing / Protection type				
Material	die-cast aluminum	die-cast aluminum		
Mounting	via integrated pivoted lever	via integrated pivoted lever		
Protect type front side	IP 65	IP 65		
Protect type back side	IP 20	IP 20		
Dimensions				
Front panel	325 mm x 263 mm x 7.5 mm	325 mm x 263 mm x 7.5 mm		
Rear panel	309 mm x 247 mm x 45 mm	309 mm x 247 mm x 45 mm		

SLIO
100V
200V
300S
500S
HMI
Teleservice
StarterKits
Safety
Solutions
Software
Accessories
Appendix

professional Panels professional Panels					
62F-FEE0-CB 62F-FEE0-CX 62G-FEE0-CB 62G-FEE0-CX	62I-IEE0-CB 62I-IEE0-CX 62K-JEE0-CB 62K-JEE0-CX	62M-JEE0-CB 62M-JEE0-CX			

Order number	62M-JEE0-CB	62M-JEE0-CX		
Installation cut-out				
Width	311 mm	311 mm		
Height	249 mm	249 mm		
Minimum	1.5 mm	1.5 mm		
Maximum front panel thickness	6 mm	6 mm		
Weight	3674 g	3674 g		
Environmental conditions				
Operating temperature	0 °C to 50 °C	0 °C to 50 °C		
Storage temperature	-20 °C to 60 °C	-20 °C to 60 °C		
Certifications				
UL508 certification	in preparation	in preparation		

Connections, Interfaces

professional Panels | professional Panels

62F-FEE0-CB 62F-FEE0-CX 62G-FEE0-CB 62G-FEE0-CX	62I-IEE0-CB 62I-IEE0-CX 62K-JEE0-CB 62K-JEE0-CX	62M-JEE0-CB 62M-JEE0-CX				
--	--	----------------------------	--	--	--	--

62M-JEE0-CB

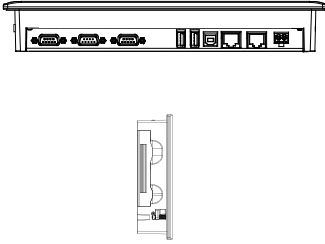

RS422/485

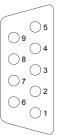

- ① n.c.
- ② n.c.
- ③ TxD
- ④ RxD
- ⑤ MSV
- ⑥ P5V
- ⑦ n.c.
- ⑧ TxD-
- ⑨ RxD-

RS232

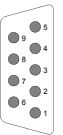

- ① CD-
- ② RxD
- ③ TxD
- ④ DTR
- ⑤ GND
- ⑥ DSR
- ⑦ RTS
- ⑧ CTS
- ⑨ RI

MPI PROFIBUS DP

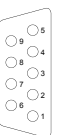

- ① n.c.
- ② M24V
- ③ RxD/TxD-P (line B)
- ④ RTS
- ⑤ MSV
- ⑥ P5V
- ⑦ P24V
- ⑧ RxD/TxD-N (line A)
- ⑨ n.c.

USB-A 2x



- ① VCC
- ② DM
- ③ DP
- ④ GND

USB-B



- ① VCC
- ② DM
- ③ DP
- ④ GND

RJ45 2x



- ① Tx+
- ② Tx-
- ③ Rb+
- ④ -
- ⑤ -
- ⑥ Rb-
- ⑦ -
- ⑧ -

DC 24V



-
- +

62M-JEE0-CX

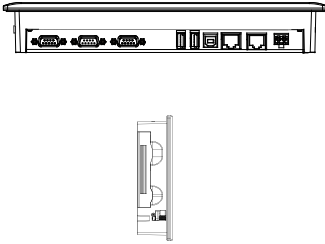

RS422/485



- ① n.c.
- ② n.c.
- ③ TxD
- ④ RxD
- ⑤ MSV
- ⑥ P5V
- ⑦ n.c.
- ⑧ TxD-
- ⑨ RxD-

RS232

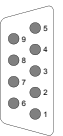

- ① CD-
- ② RxD
- ③ TxD
- ④ DTR
- ⑤ GND
- ⑥ DSR
- ⑦ RTS
- ⑧ CTS
- ⑨ RI

MPI PROFIBUS DP

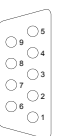

- ① n.c.
- ② M24V
- ③ RxD/TxD-P (line B)
- ④ RTS
- ⑤ MSV
- ⑥ P5V
- ⑦ P24V
- ⑧ RxD/TxD-N (line A)
- ⑨ n.c.

USB-A 2x



- ① VCC
- ② DM
- ③ DP
- ④ GND

USB-B



- ① VCC
- ② DM
- ③ DP
- ④ GND

RJ45 2x



- ① Tx+
- ② Tx-
- ③ Rb+
- ④ -
- ⑤ -
- ⑥ Rb-
- ⑦ -
- ⑧ -

DC 24V



-
- +

eco Panels



Structure and Function

The new ecoPanels enable completely new and attractive possibilities for mechanical and system engineers: efficient visualization at attractive prices: Manifold application possibilities. The ecoPanel series are not only distinguished by uncompromising reliability and performance, but impressive by an unsurpassed price-performance ratio. Of course, we also paid attention to durability and quality of the products. This is achieved amongst others by a special construction, which enables a fanless and disc free operation. This means there are no moving parts inside the unit.

The VIPA ecoPanels in combination with Movicon Basic (full-valued + unlimited Basic license) offers incomparable advantages. The software concentrates the powerful Movicon technology in a simplified form into an extremely user friendly editing environment. This enables a high scalability and a considerable increase in performance for every project.

Characteristics

- › Display size: 4,3", 7", 10", 15"
- › Type of display: TFT Color
- › Processor: ARM11 533MHz+ / Cortex-A8 1000MHz
- › Interfaces: RS232, RS485, RS422, MPI, PROFIBUS-DP slave, Ethernet RJ45, USB-A, USB-B (depending on type of panel)
- › Memory: already integrated, also with SD and USB-Stick expendable
- › Including VIPA PLCTOOL: (allows upload/download of programmes from VIPA- and Step7 based controls, reading of the diagnosis buffer, as well as start and stop of the connected CPUs without using a programming unit)
- › Including of the operating system Windows Embedded CE 6.0 Core and visualization system Movicon BASIC

Visualization system Movicon:

- › Editor for vector graphics with powerful and attractive library of characters
- › Extensive I/O driver library (import of variables from the PLC possible)
- › Powerful alarm management
- › Interference and operation data acquisition including evaluation possibility
- › Archiving of process data with trend curves
- › Extensive driver library
- › Scalability of the project of basic systems to Movicon Scada platform
- › Multilingual support
- › Save and extensive user management
- › Remote management for projecting and remote maintenance
- › Remote access via standard VNC client possible
- › Integrated Ethernet TCP/IP networking
- › Integrated AWL logic (STEP5/STEP7)
- › Also deployable in combination with many controllers of different manufacturers

Overview





Order no.	Name/Description	Page
eco Panels		
62E-MDC0-DH	Touch Panel TP 604LC ▶ 4,3", TFT, 480x272 Pixel ▶ ARM11 processor, 533MHz ▶ 128 MB work memory, 128 MB user memory ▶ RS232, RS422/485, USB-A, Ethernet RJ45 (MPI/DP interface optional available) ▶ Windows Embedded CE 6.0 Core, Movicon Basic Runtime (62E-MDC0-DH)	610
62E-MGC0-CB	Touch Panel TP 604LC ▶ 4,3", TFT, 480x272 Pixel ▶ ARM11 processor, 533MHz ▶ 128 MB work memory, 128 MB user memory ▶ RS232, RS422/485, USB-A, Ethernet RJ45 (MPI/DP interface optional available) ▶ Windows Embedded CE 6.0 Core, Movicon Basic Runtime (62E-MDC0-DH)	610
62H-MDC0-DH	Touch Panel TP 607LC ▶ 7", TFT, 800x480 pixel ▶ ARM11 processor, 533MHz ▶ 128 MB work memory, 128 MB user memory ▶ RS232, RS422/485, USB-A, Ethernet RJ45 (MPI/DP interface optional available) ▶ Windows Embedded CE 6.0 Core, Movicon Basic Runtime (62H-MDC0-DH)	610
62H-MGC0-CB	Touch Panel TP 607LC ▶ 7", TFT, 800x480 pixel ▶ ARM11 processor, 533MHz ▶ 128 MB work memory, 128 MB user memory ▶ RS232, RS422/485, USB-A, Ethernet RJ45 (MPI/DP interface optional available) ▶ Windows Embedded CE 6.0 Core, Movicon Basic Runtime (62H-MDC0-DH)	610
62K-NHC0-DH	Touch Panel TP 610LC ▶ 10", TFT, 1024x768 Pixel ▶ Cortex-A8 processor, 1000MHz ▶ 256 MB work memory, 128 MB user memory ▶ RS232, RS232/RS422/485, USB-A, 2x Ethernet RJ45 (MPI/DP interface optional available) ▶ Windows Embedded CE 6.0 Core, Movicon Basic Runtime (62K-NHC0-DH)	614
62K-NHC0-CB	Touch Panel TP 610LC ▶ 10", TFT, 1024x768 Pixel ▶ Cortex-A8 processor, 1000MHz ▶ 256 MB work memory, 128 MB user memory ▶ RS232, RS232/RS422/485, USB-A, 2x Ethernet RJ45 (MPI/DP interface optional available) ▶ Windows Embedded CE 6.0 Core, Movicon Basic Runtime (62K-NHC0-DH)	614
62P-NHC0-DH	Touch Panel TP 615LC ▶ 15", TFT, 1024x768 pixel ▶ Cortex-A8 processor, 1000MHz ▶ 256 MB work memory, 128 MB user memory ▶ RS232, RS232/RS422/485, USB-A, 2x Ethernet RJ45 (MPI/DP interface optional available) ▶ Windows Embedded CE 6.0 Core, Movicon Basic Runtime (62P-NHC0-DH)	614
62P-NHC0-CB	Touch Panel TP 615LC ▶ 15", TFT, 1024x768 pixel ▶ Cortex-A8 processor, 1000MHz ▶ 256 MB work memory, 128 MB user memory ▶ RS232, RS232/RS422/485, USB-A, 2x Ethernet RJ45 (MPI/DP interface optional available) ▶ Windows Embedded CE 6.0 Core, Movicon Basic Runtime (62P-NHC0-DH)	614
Optional interfaces		
961-OMPO	MPI/PROFIBUS-DP interface ▶ For optional retrofitting of the MPI/DP interfaces at eco panels series	618

eco Panels

eco Panels | eco Panels

62E-MDC0-DH
62E-MGC0-CB
62H-MDC0-DH
62H-MGC0-CB

62K-NHC0-DH
62K-NHC0-CB
62P-NHC0-DH
62P-NHC0-CB

Order number	62E-MDC0-DH	62E-MGC0-CB	62H-MDC0-DH	62H-MGC0-CB
Figure				
Type	Touch Panel TP 604LC	Touch Panel TP 604LC	Touch Panel TP 607LC	Touch Panel TP 607LC
General information				
Note	-	-	-	-
Features	<ul style="list-style-type: none"> ▸ 4,3", TFT, 480x272 Pixel ▸ ARM11 processor, 533MHz ▸ 128 MB work memory, 128 MB user memory ▸ RS232, RS422/485, USB-A, Ethernet RJ45 (MPI/DP interface optional available) ▸ Windows Embedded CE 6.0 Core, Movicon Basic Runtime (62E-MDC0-DH) 	<ul style="list-style-type: none"> ▸ 4,3", TFT, 480x272 Pixel ▸ ARM11 processor, 533MHz ▸ 128 MB work memory, 128 MB user memory ▸ RS232, RS422/485, USB-A, Ethernet RJ45 (MPI/DP interface optional available) ▸ Windows Embedded CE 6.0 Core, Movicon Basic Runtime (62E-MDC0-DH) 	<ul style="list-style-type: none"> ▸ 7", TFT, 800x480 pixel ▸ ARM11 processor, 533MHz ▸ 128 MB work memory, 128 MB user memory ▸ RS232, RS422/485, USB-A, Ethernet RJ45 (MPI/DP interface optional available) ▸ Windows Embedded CE 6.0 Core, Movicon Basic Runtime (62H-MDC0-DH) 	<ul style="list-style-type: none"> ▸ 7", TFT, 800x480 pixel ▸ ARM11 processor, 533MHz ▸ 128 MB work memory, 128 MB user memory ▸ RS232, RS422/485, USB-A, Ethernet RJ45 (MPI/DP interface optional available) ▸ Windows Embedded CE 6.0 Core, Movicon Basic Runtime (62H-MDC0-DH)
Display				
Display size (diagonal)	4.3 "	4.3 "	7 "	7 "
Display size (width)	95 mm	95 mm	152 mm	152 mm
Display size (height)	54 mm	54 mm	91 mm	91 mm
Resolution	272 x 480 / 480 x 272	272 x 480 / 480 x 272	480 x 800 / 800 x 480	480 x 800 / 800 x 480
Aspect ratio	16:9	16:9	5:3	5:3
Type of display	TFT color (64K colors)	TFT color (64K colors)	TFT color (64K colors)	TFT color (64K colors)
MTBF Backlights (25°C)	30000 h	30000 h	50000 h	50000 h
System properties				
Processor	ARM11 533 MHz	Cortex-A8 667 MHz	ARM11 533 MHz	Cortex-A8 667 MHz
Operating system	Windows CE 6.0 Core	Windows CE 6.0 Prof.	Windows CE 6.0 Core	Windows CE 6.0 Prof.
User software	Movicon 11 CE Basic	Movicon 11 CE Standard	Movicon 11 CE Basic	Movicon 11 CE Standard
Work memory	128 MB	256 MB	128 MB	256 MB
User memory	128 MB	128 MB	128 MB	128 MB
Available memory (user data)	50 MB	50 MB	50 MB	50 MB
SD/MMC Slot	✓	✓	✓	✓
CF Card Slot Typ II	-	-	-	-
Time				
Real-time clock buffered	✓	✓	✓	✓
Clock buffered period (min.)	26 w	26 w	26 w	26 w
Type of buffering	-	-	-	-
Load time for 50% buffering period	5 h	5 h	5 h	5 h
Load time for 100% buffering period	24 h	24 h	24 h	24 h
Accuracy (max. deviation per day)	2 s	2 s	2 s	2 s

eco Panels | eco Panels

62E-MDC0-DH	62K-NHC0-DH				
62E-MGC0-CB	62K-NHC0-CB				
62H-MDC0-DH	62P-NHC0-DH				
62H-MGC0-CB	62P-NHC0-CB				

Order number	62E-MDC0-DH	62E-MGC0-CB	62H-MDC0-DH	62H-MGC0-CB
Operating controls				
Touchscreen	resistive	resistive	resistive	resistive
Keyboard	external via USB	external via USB	external via USB	external via USB
Mouse	external via USB	external via USB	external via USB	external via USB
Interfaces				
MPI, PROFIBUS-DP	optional	optional	optional	optional
MPI, PROFIBUS-DP connector	-	-	-	-
Serial, COM1	RS232	RS232	RS232	RS232
COM1 connector	Sub-D, 9-pin, male	Sub-D, 9-pin, male	Sub-D, 9-pin, male	Sub-D, 9-pin, male
Serial, COM2	RS232 / RS422 / RS485	RS232 / RS422 / RS485	RS232 / RS422 / RS485	RS232 / RS422 / RS485
COM2 connector	Sub-D, 25-pin, female	Sub-D, 25-pin, female	Sub-D, 25-pin, female	Sub-D, 25-pin, female
Number of USB-A interfaces	1	1	1	1
USB-A connector	USB-A (host)	USB-A (host)	USB-A (host)	USB-A (host)
Number of USB-B interfaces	-	-	-	-
USB-B connector	-	-	-	-
Number of ethernet interfaces	1	1	1	1
Ethernet	Ethernet 10/100 MBit	Ethernet 10/100 MBit	Ethernet 10/100 MBit	Ethernet 10/100 MBit
Ethernet connector	RJ45	RJ45	RJ45	RJ45
Integrated ethernet switch	-	-	-	-
Technical data power supply				
Power supply (rated value)	DC 24 V	DC 24 V	DC 24 V	DC 24 V
Power supply (permitted range)	DC 20.4...28.8 V	DC 20.4...28.8 V	DC 20.4...28.8 V	DC 20.4...28.8 V
Reverse polarity protection	✓	✓	✓	✓
Current consumption (no-load operation)	0.16 A	0.16 A	0.24 A	0.24 A
Current consumption (rated value)	0.3 A	0.3 A	0.4 A	0.4 A
Inrush current	75 A	75 A	85 A	85 A
I ² t	0.36 A ² s	0.36 A ² s	0.43 A ² s	0.43 A ² s
Power loss	6 W	6 W	8 W	8 W
Status information, alarms, diagnostics				
Supply voltage display	none	none	none	none
Mechanical data				
Housing / Protection type				
Material	PC	PC	PC	PC
Mounting	mounting clips	mounting clips	mounting clips	mounting clips
Protect type front side	IP 65	IP 65	IP 65	IP 65
Protect type back side	IP 20	IP 20	IP 20	IP 20
Dimensions				
Front panel	140 mm x 116 mm x 6 mm	140 mm x 116 mm x 6 mm	212 mm x 156 mm x 6 mm	212 mm x 156 mm x 6 mm
Rear panel	122 mm x 98 mm x 51 mm	122 mm x 98 mm x 51 mm	196 mm x 140 mm x 51 mm	196 mm x 140 mm x 51 mm

eco Panels eco Panels						
62E-MDC0-DH	62K-NHC0-DH					
62E-MGC0-CB	62K-NHC0-CB					
62H-MDC0-DH	62P-NHC0-DH					
62H-MGC0-CB	62P-NHC0-CB					

Order number	62E-MDC0-DH	62E-MGC0-CB	62H-MDC0-DH	62H-MGC0-CB
Installation cut-out				
Width	123 mm	123 mm	198 mm	198 mm
Height	99 mm	99 mm	142 mm	142 mm
Minimum	2.5 mm	2.5 mm	2.5 mm	2.5 mm
Maximum front panel thickness	6 mm	6 mm	6 mm	6 mm
Weight	500 g	500 g	1200 g	1200 g
Environmental conditions				
Operating temperature	0 °C to 50 °C	0 °C to 50 °C	0 °C to 50 °C	0 °C to 50 °C
Storage temperature	-20 °C to 60 °C	-20 °C to 60 °C	-20 °C to 60 °C	-20 °C to 60 °C
Certifications				
UL508 certification	yes	yes	yes	yes

Connections, Interfaces

eco Panels | eco Panels

62E-MDC0-DH	62K-NHC0-DH				
62E-MGC0-CB	62K-NHC0-CB				
62H-MDC0-DH	62P-NHC0-DH				
62H-MGC0-CB	62P-NHC0-CB				

62E-MDC0-DH

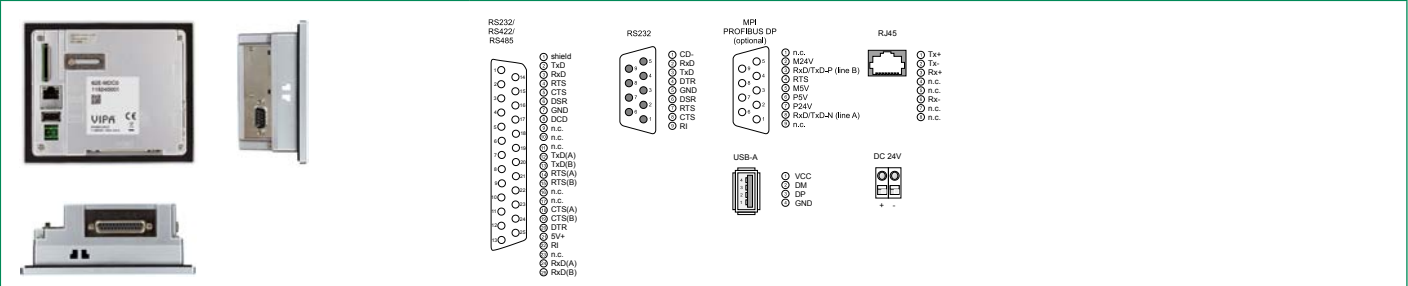

62E-MDC0-DH panel and connector diagrams. The diagrams show the RS232/RS422/RS485 connector with pins: shield, TXD, RXD, RTS, CTS, DSR, GND, DCD, n.c., TXD(A), TXD(B), RTS(A), RTS(B), n.c., CTS(A), CTS(B), DTR, SV+, RI, n.c., RD(A), RD(B). The RS232 connector has pins: CD, RXD, TXD, DTR, GND, DSR, RTS, CTS, RI. The optional MPI PROFIBUS DP connector has pins: n.c., M24V, RxD/TxD-P (line B), RTS, M5V, P5V, P24V, RxD/TxD-N (line A), n.c. The USB-A connector has pins: VCC, DM, GP, GND. The RJ45 connector has pins: Tx+, Tx-, Rx+, Rx-, n.c., n.c., n.c., n.c. The DC 24V connector has pins: +, -.

62E-MGC0-CB

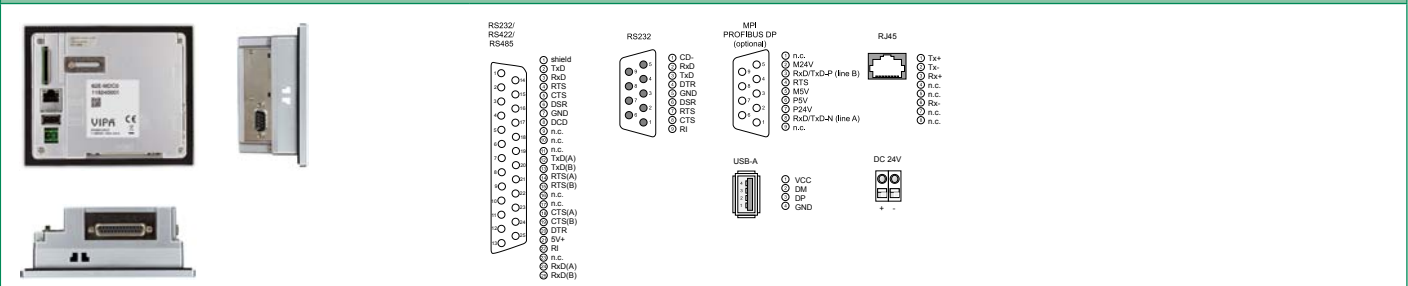

62E-MGC0-CB panel and connector diagrams. The diagrams show the RS232/RS422/RS485 connector with pins: shield, TXD, RXD, RTS, CTS, DSR, GND, DCD, n.c., TXD(A), TXD(B), RTS(A), RTS(B), n.c., CTS(A), CTS(B), DTR, SV+, RI, n.c., RD(A), RD(B). The RS232 connector has pins: CD, RXD, TXD, DTR, GND, DSR, RTS, CTS, RI. The optional MPI PROFIBUS DP connector has pins: n.c., M24V, RxD/TxD-P (line B), RTS, M5V, P5V, P24V, RxD/TxD-N (line A), n.c. The USB-A connector has pins: VCC, DM, GP, GND. The RJ45 connector has pins: Tx+, Tx-, Rx+, Rx-, n.c., n.c., n.c., n.c. The DC 24V connector has pins: +, -.

62H-MDC0-DH

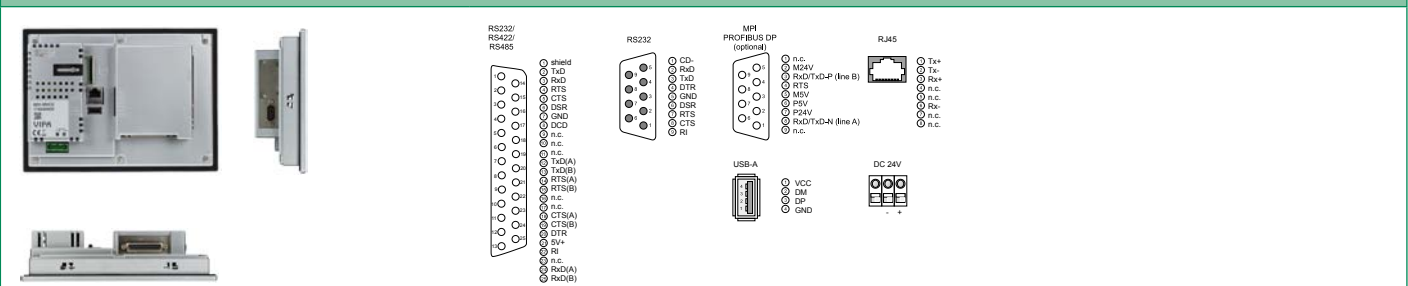

62H-MDC0-DH panel and connector diagrams. The diagrams show the RS232/RS422/RS485 connector with pins: shield, TXD, RXD, RTS, CTS, DSR, GND, DCD, n.c., TXD(A), TXD(B), RTS(A), RTS(B), n.c., CTS(A), CTS(B), DTR, SV+, RI, n.c., RD(A), RD(B). The RS232 connector has pins: CD, RXD, TXD, DTR, GND, DSR, RTS, CTS, RI. The optional MPI PROFIBUS DP connector has pins: n.c., M24V, RxD/TxD-P (line B), RTS, M5V, P5V, P24V, RxD/TxD-N (line A), n.c. The USB-A connector has pins: VCC, DM, GP, GND. The RJ45 connector has pins: Tx+, Tx-, Rx+, Rx-, n.c., n.c., n.c., n.c. The DC 24V connector has pins: +, -.

62H-MGC0-CB

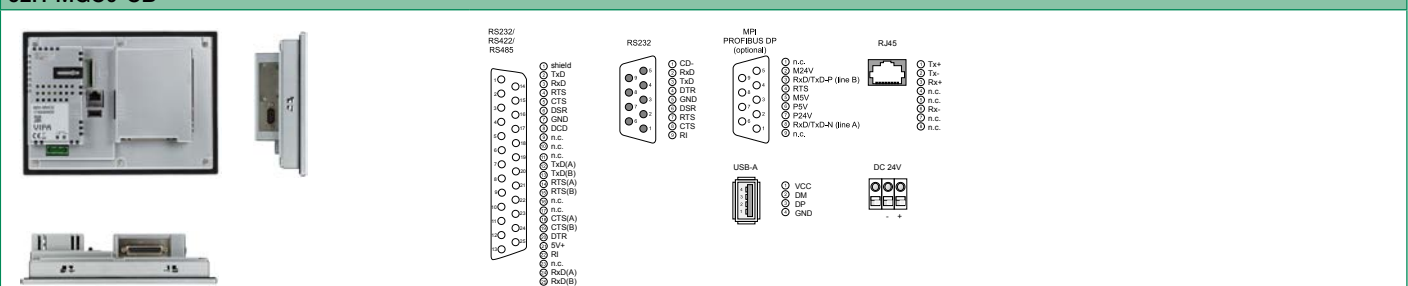





62H-MGC0-CB panel and connector diagrams. The diagrams show the RS232/RS422/RS485 connector with pins: shield, TXD, RXD, RTS, CTS, DSR, GND, DCD, n.c., TXD(A), TXD(B), RTS(A), RTS(B), n.c., CTS(A), CTS(B), DTR, SV+, RI, n.c., RD(A), RD(B). The RS232 connector has pins: CD, RXD, TXD, DTR, GND, DSR, RTS, CTS, RI. The optional MPI PROFIBUS DP connector has pins: n.c., M24V, RxD/TxD-P (line B), RTS, M5V, P5V, P24V, RxD/TxD-N (line A), n.c. The USB-A connector has pins: VCC, DM, GP, GND. The RJ45 connector has pins: Tx+, Tx-, Rx+, Rx-, n.c., n.c., n.c., n.c. The DC 24V connector has pins: +, -.

eco Panels

eco Panels | eco Panels

62E-MDC0-DH
62E-MGC0-CB
62H-MDC0-DH
62H-MGC0-CB

62K-NHC0-DH
62K-NHC0-CB
62P-NHC0-DH
62P-NHC0-CB

Order number	62K-NHC0-DH	62K-NHC0-CB	62P-NHC0-DH	62P-NHC0-CB
Figure				
Type	Touch Panel TP 610LC	Touch Panel TP 610LC	Touch Panel TP 615LC	Touch Panel TP 615LC
General information				
Note	-	-	-	-
Features	<ul style="list-style-type: none"> ▶ 10", TFT, 1024x768 Pixel ▶ Cortex-A8 processor, 1000MHz ▶ 256 MB work memory, 128 MB user memory ▶ RS232, RS232/RS422/485, USB-A, 2x Ethernet RJ45 (MPI/DP interface optional available) ▶ Windows Embedded CE 6.0 Core, Movicon Basic Runtime (62K-NHC0-DH) 	<ul style="list-style-type: none"> ▶ 10", TFT, 1024x768 Pixel ▶ Cortex-A8 processor, 1000MHz ▶ 256 MB work memory, 128 MB user memory ▶ RS232, RS232/RS422/485, USB-A, 2x Ethernet RJ45 (MPI/DP interface optional available) ▶ Windows Embedded CE 6.0 Core, Movicon Basic Runtime (62K-NHC0-CB) 	<ul style="list-style-type: none"> ▶ 15", TFT, 1024x768 pixel ▶ Cortex-A8 processor, 1000MHz ▶ 256 MB work memory, 128 MB user memory ▶ RS232, RS232/RS422/485, USB-A, 2x Ethernet RJ45 (MPI/DP interface optional available) ▶ Windows Embedded CE 6.0 Core, Movicon Basic Runtime (62P-NHC0-DH) 	<ul style="list-style-type: none"> ▶ 15", TFT, 1024x768 pixel ▶ Cortex-A8 processor, 1000MHz ▶ 256 MB work memory, 128 MB user memory ▶ RS232, RS232/RS422/485, USB-A, 2x Ethernet RJ45 (MPI/DP interface optional available) ▶ Windows Embedded CE 6.0 Core, Movicon Basic Runtime (62P-NHC0-CB)
Display				
Display size (diagonal)	10 "	10 "	15 "	15 "
Display size (width)	203 mm	203 mm	304 mm	304 mm
Display size (height)	152 mm	152 mm	228 mm	228 mm
Resolution	768 x 1024 / 1024 x 768	768 x 1024 / 1024 x 768	768 x 1024 / 1024 x 768	768 x 1024 / 1024 x 768
Aspect ratio	4:3	4:3	4:3	4:3
Type of display	TFT color (64K colors)	TFT color (64K colors)	TFT color (64K colors)	TFT color (64K colors)
MTBF Backlights (25°C)	50000 h	50000 h	50000 h	50000 h
System properties				
Processor	Cortex-A8 1000 MHz	Cortex-A8 1000 MHz	Cortex-A8 1000 MHz	Cortex-A8 1000 MHz
Operating system	Windows CE 6.0 Core	Windows CE 6.0 Prof.	Windows CE 6.0 Core	Windows CE 6.0 Prof.
User software	Movicon 11 CE Basic	Movicon 11 CE Standard	Movicon 11 CE Basic	Movicon 11 CE Standard
Work memory	256 MB	256 MB	256 MB	256 MB
User memory	128 MB	128 MB	128 MB	128 MB
Available memory (user data)	50 MB	50 MB	50 MB	50 MB
SD/MMC Slot	✓	✓	✓	✓
CF Card Slot Typ II	-	-	-	-
Time				
Real-time clock buffered	✓	✓	✓	✓
Clock buffered period (min.)	26 w	26 w	26 w	26 w
Type of buffering	-	-	-	-
Load time for 50% buffering period	5 h	5 h	5 h	5 h
Load time for 100% buffering period	24 h	24 h	24 h	24 h
Accuracy (max. deviation per day)	2 s	2 s	2 s	2 s

eco Panels | eco Panels

62E-MDC0-DH	62K-NHC0-DH				
62E-MGC0-CB	62K-NHC0-CB				
62H-MDC0-DH	62P-NHC0-DH				
62H-MGC0-CB	62P-NHC0-CB				

Order number	62K-NHC0-DH	62K-NHC0-CB	62P-NHC0-DH	62P-NHC0-CB
Operating controls				
Touchscreen	resistive	resistive	resistive	resistive
Keyboard	external via USB	external via USB	external via USB	external via USB
Mouse	external via USB	external via USB	external via USB	external via USB
Interfaces				
MPI, PROFIBUS-DP	optional	optional	optional	optional
MPI, PROFIBUS-DP connector	-	-	-	-
Serial, COM1	RS232	RS232	RS232	RS232
COM1 connector	Sub-D, 9-pin, male	Sub-D, 9-pin, male	Sub-D, 9-pin, male	Sub-D, 9-pin, male
Serial, COM2	RS232 / RS422 / RS485	RS232 / RS422 / RS485	RS232 / RS422 / RS485	RS232 / RS422 / RS485
COM2 connector	Sub-D, 25-pin, female	Sub-D, 25-pin, female	Sub-D, 25-pin, female	Sub-D, 25-pin, female
Number of USB-A interfaces	1	1	1	1
USB-A connector	USB-A (host)	USB-A (host)	USB-A (host)	USB-A (host)
Number of USB-B interfaces	-	-	-	-
USB-B connector	-	-	-	-
Number of ethernet interfaces	2	2	2	2
Ethernet	Ethernet 10/100 MBit	Ethernet 10/100 MBit	Ethernet 10/100 MBit	Ethernet 10/100 MBit
Ethernet connector	RJ45	RJ45	RJ45	RJ45
Integrated ethernet switch	-	-	-	-
Technical data power supply				
Power supply (rated value)	DC 24 V	DC 24 V	DC 24 V	DC 24 V
Power supply (permitted range)	DC 20.4...28.8 V	DC 20.4...28.8 V	DC 20.4...28.8 V	DC 20.4...28.8 V
Reverse polarity protection	✓	✓	✓	✓
Current consumption (no-load operation)	0.24 A	0.24 A	0.24 A	0.24 A
Current consumption (rated value)	1.36 A	1.36 A	2.46 A	2.46 A
Inrush current	85 A	85 A	85 A	85 A
I ² t	0.34 A ² s	0.34 A ² s	0.37 A ² s	0.37 A ² s
Power loss	15 W	15 W	27 W	27 W
Status information, alarms, diagnostics				
Supply voltage display	none	none	none	none
Mechanical data				
Housing / Protection type				
Material	aluminum, galvanized steel	aluminum, galvanized steel	aluminum, galvanized steel	aluminum, galvanized steel
Mounting	mounting clips	mounting clips	mounting clips	mounting clips
Protect type front side	IP 65	IP 65	IP 65	IP 65
Protect type back side	IP 20	IP 20	IP 20	IP 20
Dimensions				
Front panel	325 mm x 263 mm x 6 mm	325 mm x 263 mm x 6 mm	400 mm x 310 mm x 6 mm	400 mm x 310 mm x 6 mm
Rear panel	310 mm x 248 mm x 50 mm	310 mm x 248 mm x 50 mm	367 mm x 289 mm x 50 mm	367 mm x 289 mm x 50 mm

eco Panels eco Panels					
62E-MDC0-DH	62K-NHC0-DH				
62E-MGC0-CB	62K-NHC0-CB				
62H-MDC0-DH	62P-NHC0-DH				
62H-MGC0-CB	62P-NHC0-CB				

Order number	62K-NHC0-DH	62K-NHC0-CB	62P-NHC0-DH	62P-NHC0-CB
Installation cut-out				
Width	311 mm	311 mm	368 mm	368 mm
Height	249 mm	249 mm	290 mm	290 mm
Minimum	2.5 mm	2.5 mm	2.5 mm	2.5 mm
Maximum front panel thickness	6 mm	6 mm	6 mm	6 mm
Weight	3350 g	3350 g	4900 g	4900 g
Environmental conditions				
Operating temperature	0 °C to 50 °C	0 °C to 50 °C	0 °C to 50 °C	0 °C to 50 °C
Storage temperature	-20 °C to 60 °C	-20 °C to 60 °C	-20 °C to 60 °C	-20 °C to 60 °C
Certifications				
UL508 certification	yes	yes	yes	yes

Connections, Interfaces

eco Panels | eco Panels

62E-MDC0-DH	62K-NHC0-DH
62E-MGC0-CB	62K-NHC0-CB
62H-MDC0-DH	62P-NHC0-DH
62H-MGC0-CB	62P-NHC0-CB

62K-NHC0-DH



RS232/RS422/RS485

- ① shield
- ② TxD
- ③ RxD
- ④ RTS
- ⑤ CTS
- ⑥ DSR
- ⑦ GND
- ⑧ DCD
- ⑨ n.c.
- ⑩ n.c.
- ⑪ TxD(A)
- ⑫ TxD(B)
- ⑬ RTS(A)
- ⑭ RTS(B)
- ⑮ n.c.
- ⑯ n.c.
- ⑰ CTS(A)
- ⑱ CTS(B)
- ⑲ DTR
- ⑳ SW+
- ㉑ RS
- ㉒ n.c.
- ㉓ RxD(A)
- ㉔ RxD(B)

RS232

- ① CD-
- ② RxD
- ③ TxD
- ④ DTR
- ⑤ GND
- ⑥ DSR
- ⑦ RTS
- ⑧ CTS
- ⑨ RI

MPI/PROFIBUS DP

- ① n.c.
- ② M24V
- ③ RxD/TxD-P (line B)
- ④ RTS
- ⑤ M5V
- ⑥ PSV
- ⑦ P24V
- ⑧ RxD/TxD-N (line A)
- ⑨ n.c.

RJ45

- ① Tx+
- ② Tx-
- ③ Rx+
- ④ Rx-
- ⑤ -
- ⑥ -
- ⑦ -
- ⑧ -

USB-A

- ① VCC
- ② DM
- ③ DP
- ④ GND

DC 24V

- ① PE -
- ② +

62K-NHC0-CB



RS232/RS422/RS485

- ① shield
- ② TxD
- ③ RxD
- ④ RTS
- ⑤ CTS
- ⑥ DSR
- ⑦ GND
- ⑧ DCD
- ⑨ n.c.
- ⑩ n.c.
- ⑪ TxD(A)
- ⑫ TxD(B)
- ⑬ RTS(A)
- ⑭ RTS(B)
- ⑮ n.c.
- ⑯ n.c.
- ⑰ CTS(A)
- ⑱ CTS(B)
- ⑲ DTR
- ⑳ SW+
- ㉑ RS
- ㉒ n.c.
- ㉓ RxD(A)
- ㉔ RxD(B)

RS232

- ① CD-
- ② RxD
- ③ TxD
- ④ DTR
- ⑤ GND
- ⑥ DSR
- ⑦ RTS
- ⑧ CTS
- ⑨ RI

MPI/PROFIBUS DP

- ① n.c.
- ② M24V
- ③ RxD/TxD-P (line B)
- ④ RTS
- ⑤ M5V
- ⑥ PSV
- ⑦ P24V
- ⑧ RxD/TxD-N (line A)
- ⑨ n.c.

RJ45

- ① Tx+
- ② Tx-
- ③ Rx+
- ④ Rx-
- ⑤ -
- ⑥ -
- ⑦ -
- ⑧ -

USB-A

- ① VCC
- ② DM
- ③ DP
- ④ GND

DC 24V

- ① PE -
- ② +

62P-NHC0-DH



RS232/RS422/RS485

- ① shield
- ② TxD
- ③ RxD
- ④ RTS
- ⑤ CTS
- ⑥ DSR
- ⑦ GND
- ⑧ DCD
- ⑨ n.c.
- ⑩ n.c.
- ⑪ TxD(A)
- ⑫ TxD(B)
- ⑬ RTS(A)
- ⑭ RTS(B)
- ⑮ n.c.
- ⑯ n.c.
- ⑰ CTS(A)
- ⑱ CTS(B)
- ⑲ DTR
- ⑳ SW+
- ㉑ RS
- ㉒ n.c.
- ㉓ RxD(A)
- ㉔ RxD(B)

RS232

- ① CD-
- ② RxD
- ③ TxD
- ④ DTR
- ⑤ GND
- ⑥ DSR
- ⑦ RTS
- ⑧ CTS
- ⑨ RI

MPI/PROFIBUS DP

- ① n.c.
- ② M24V
- ③ RxD/TxD-P (line B)
- ④ RTS
- ⑤ M5V
- ⑥ PSV
- ⑦ P24V
- ⑧ RxD/TxD-N (line A)
- ⑨ n.c.

RJ45

- ① Tx+
- ② Tx-
- ③ Rx+
- ④ Rx-
- ⑤ -
- ⑥ -
- ⑦ -
- ⑧ -

USB-A

- ① VCC
- ② DM
- ③ DP
- ④ GND

DC 24V

- ① PE -
- ② +

62P-NHC0-CB



RS232/RS422/RS485

- ① shield
- ② TxD
- ③ RxD
- ④ RTS
- ⑤ CTS
- ⑥ DSR
- ⑦ GND
- ⑧ DCD
- ⑨ n.c.
- ⑩ n.c.
- ⑪ TxD(A)
- ⑫ TxD(B)
- ⑬ RTS(A)
- ⑭ RTS(B)
- ⑮ n.c.
- ⑯ n.c.
- ⑰ CTS(A)
- ⑱ CTS(B)
- ⑲ DTR
- ⑳ SW+
- ㉑ RS
- ㉒ n.c.
- ㉓ RxD(A)
- ㉔ RxD(B)

RS232

- ① CD-
- ② RxD
- ③ TxD
- ④ DTR
- ⑤ GND
- ⑥ DSR
- ⑦ RTS
- ⑧ CTS
- ⑨ RI

MPI/PROFIBUS DP

- ① n.c.
- ② M24V
- ③ RxD/TxD-P (line B)
- ④ RTS
- ⑤ M5V
- ⑥ PSV
- ⑦ P24V
- ⑧ RxD/TxD-N (line A)
- ⑨ n.c.

RJ45

- ① Tx+
- ② Tx-
- ③ Rx+
- ④ Rx-
- ⑤ -
- ⑥ -
- ⑦ -
- ⑧ -

USB-A

- ① VCC
- ② DM
- ③ DP
- ④ GND

DC 24V

- ① PE -
- ② +

Optional interfaces

eco Panels Optional interfaces						
961-0MP0						

Order number	961-0MP0			
Figure				
Type	-			
General information				
Note	-			
Features	<ul style="list-style-type: none"> ▸ For optional retro-fitting of the MPI/DP interfaces at eco panels series 			

Connections, Interfaces

eco Panels | Optional interfaces

961-OMP0						
----------	--	--	--	--	--	--

961-OMP0



RS485

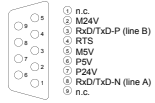

Panel PC



Structure and concept

The combination of industrial PC with state of the art performance features and a Touch Panel with ideal display capabilities enables the user to concentrate high performance into the smallest space. The latest Intel Atom processor technology, large integrated work memory and display resolutions of up to Full HD with the 21.5" panel PC are state of the art. The panels have also numerous useful interfaces just like other VIPA Touch Panels. The pre-installed operating systems Windows Embedded Compact 7 or Windows Embedded Standard 7 are state of the art in the PC world. For visualization your own programs or optionally the latest pre-installed Movicon visualization can be chosen.

Features

- › Display size: 15,6" wide (16:9) und 21,5" wide (16:9)
- › Display resolution: 1366x768 (15,6") und 1920x1080 (21,5")
- › Display type: PCAP, Multitouch
- › Housing: metal
- › Processor: Intel Atom D2550 dualcore@1,86 GHz
- › Interfaces: 2x Ethernet (10/100/1000), 4x USB 2.0, 2x serial (RS232,RS422/RS485), Audio out
- › Memory: work memory 2GB
- › Operating system and user memory: 8GB mit WES7, 2GB mit WEC7
- › Memory card slot: CFast
- › Operating system: Windows Embedded Compact 7 oder Windows Embedded Standard 7
- › Visualization: optional Movicon 11 CE Standard pre-installed

Visualization system Movicon

- › Vector graphics editor with powerful and clear symbol library
- › Comprehensive I/O driver library (variables import from the PLC possible)
- › Efficient alarm management
- › Multi-lingual language support
- › Disturbance and operating data acquisition
- › Archiving process data with trend curves
- › Comprehensive driver library
- › Project scalability of Movicon basic systems to Movicon SCADA platform
- › Secure and comprehensive user management
- › Remote management for project planning and remote maintenance
- › Remote access via standard VCN client possible
- › Integrated Ethernet TCP/IP networking
- › Integrated IL logic (STEP5/STEP7)
- › Also deployable, of course, in combination with many controllers of other producers

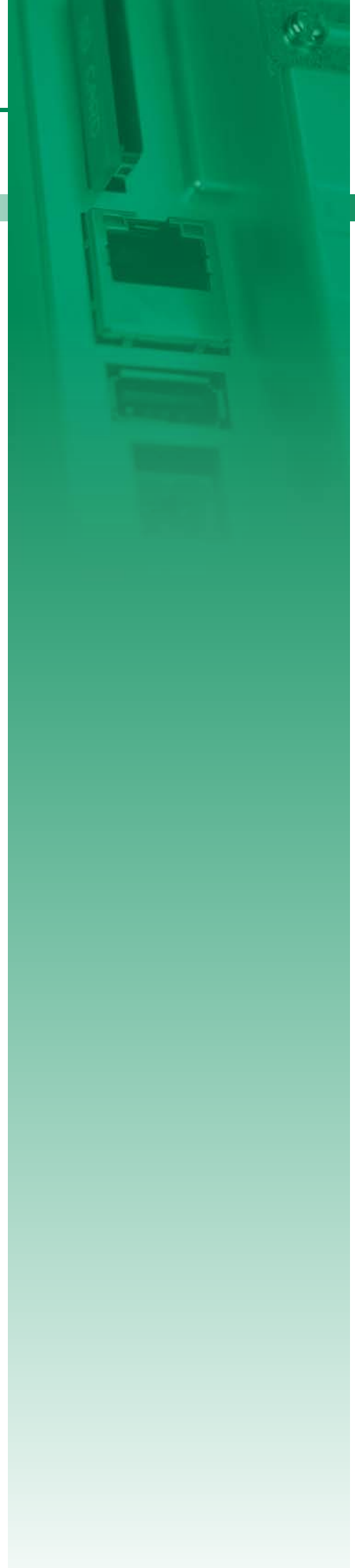





Overview

Order no.	Name/Description	Page
Panel PC		
67P-PNJ0-EB	Panel PC PPC015 CE <ul style="list-style-type: none"> › Processor: Intel Atom D2550 dualcore @1,86 GHz › Work memory: 2 GB › Operating system and user memory: 8 GB › Memory card plug-in place: CFast › Interfaces: 2x Ethernet (10/100/1000), 4x USB 2.0, 2x serial (RS232,RS422/RS485), Audio out › Display: 15,6" › Incl. Betriebssystem Windows Embedded Compact 7 and Runtime Movicon CE Standard 	622
67P-PNL0-JB	Panel PC PPC015 ES <ul style="list-style-type: none"> › Processor: Intel Atom D2550 dualcore @1,86 GHz › Work memory: 2 GB › Operating system and user memory: 8 GB › Memory card plug-in place: CFast › Interfaces: 2x Ethernet (10/100/1000), 4x USB 2.0, 2x serial (RS232,RS422/RS485), Audio out › Display: 15,6" › Incl. operating system Windows Embedded Standard 7 	622
67P-PNL0-JX	Panel PC PPC015 ES <ul style="list-style-type: none"> › Processor: Intel Atom D2550 dualcore @1,86 GHz › Work memory: 2 GB › Operating system and user memory: 8 GB › Memory card plug-in place: CFast › Interfaces: 2x Ethernet (10/100/1000), 4x USB 2.0, 2x serial (RS232,RS422/RS485), Audio out › Display: 15,6" › Incl. operating system Windows Embedded Standard 7 	622
67S-PNJ0-EB	Panel PC PPC021 CE <ul style="list-style-type: none"> › Processor: Intel Atom D2550 dualcore @1,86 GHz › Work memory: 2 GB › Operating system and user memory: 2 GB › Memory card plug-in place: CFast › Interfaces: 2x Ethernet (10/100/1000), 4x USB 2.0, 2x serial (RS232,RS422/RS485), Audio out › Display: 21,5" › Incl. operating system Windows Embedded Standard 7 and Runtime Movicon CE Standard 	622
67S-PNL0-JB	Panel PC PPC021 ES <ul style="list-style-type: none"> › Processor: Intel Atom D2550 dualcore @1,86 GHz › Work memory: 2 GB › Operating system and user memory: 8 GB › Memory card plug-in place: CFast › Interfaces: 2x Ethernet (10/100/1000), 4x USB 2.0, 2x serial (RS232,RS422/RS485), Audio out › Display: 21,5" › Incl. operating system Windows Embedded Standard 7 	626
67S-PNL0-JX	Panel PC PPC021 ES <ul style="list-style-type: none"> › Processor: Intel Atom D2550 dualcore @1,86 GHz › Work memory: 2 GB › Operating system and user memory: 8 GB › Memory card plug-in place: CFast › Interfaces: 2x Ethernet (10/100/1000), 4x USB 2.0, 2x serial (RS232,RS422/RS485), Audio out › Display: 21,5" › Incl. operating system Windows Embedded Standard 7 	626

Panel PC

Panel PC Panel PC				
67P-PNJ0-EB 67P-PNL0-JB 67P-PNL0-JX 67S-PNJ0-EB	67S-PNL0-JB 67S-PNL0-JX			

Order number	67P-PNJ0-EB	67P-PNL0-JB	67P-PNL0-JX	67S-PNJ0-EB
Figure				
Type	Panel PC PPC015 CE	Panel PC PPC015 ES	Panel PC PPC015 ES	Panel PC PPC021 CE
General information				
Note	-	-	-	-
Features	<ul style="list-style-type: none"> › Processor: Intel Atom D2550 dualcore @1,86 GHz › Work memory: 2 GB › Operating system and user memory: 8 GB › Memory card plug-in place: CFast › Interfaces: 2x Ethernet (10/100/1000), 4x USB 2.0, 2x serial (RS232,RS422/RS485), Audio out › Display: 15,6" › Incl. Betriebssystem Windows Embedded Compact 7 and Runtime Movicon CE Standard 	<ul style="list-style-type: none"> › Processor: Intel Atom D2550 dualcore @1,86 GHz › Work memory: 2 GB › Operating system and user memory: 8 GB › Memory card plug-in place: CFast › Interfaces: 2x Ethernet (10/100/1000), 4x USB 2.0, 2x serial (RS232,RS422/RS485), Audio out › Display: 15,6" › Incl. operating system Windows Embedded Standard 7 	<ul style="list-style-type: none"> › Processor: Intel Atom D2550 dualcore @1,86 GHz › Work memory: 2 GB › Operating system and user memory: 8 GB › Memory card plug-in place: CFast › Interfaces: 2x Ethernet (10/100/1000), 4x USB 2.0, 2x serial (RS232,RS422/RS485), Audio out › Display: 15,6" › Incl. operating system Windows Embedded Standard 7 	<ul style="list-style-type: none"> › Processor: Intel Atom D2550 dualcore @1,86 GHz › Work memory: 2 GB › Operating system and user memory: 2 GB › Memory card plug-in place: CFast › Interfaces: 2x Ethernet (10/100/1000), 4x USB 2.0, 2x serial (RS232,RS422/RS485), Audio out › Display: 21,5" › Incl. operating system Windows Embedded Standard 7 and Runtime Movicon CE Standard
Display				
Display size (diagonal)	15.6 "	15.6 "	15.6 "	21.5 "
Display size (width)	344 mm	344 mm	344 mm	478 mm
Display size (height)	195 mm	195 mm	195 mm	269 mm
Resolution	1366 x 768	1366 x 768	1366 x 768	1920 x 1080
Aspect ratio	16:9	16:9	16:9	16:9
Type of display	TFT color (16.7M colors)	TFT color (16.7M colors)	TFT color (16.7M colors)	TFT color (16.7M colors)
MTBF Backlights (25°C)	50000 h	50000 h	50000 h	50000 h
System properties				
Processor	Intel Atom Dualcore 1,86 GHz	Intel Atom Dualcore 1,86 GHz	Intel Atom Dualcore 1,86 GHz	Intel Atom Dualcore 1,86 GHz
Operating system	Windows embedded Compact 7	Windows embedded Standard 7	Windows embedded Standard 7	Windows embedded Compact 7
User software	Movicon 11 CE Standard	Movicon 11 Win Standard	-	Movicon 11 CE Standard
Work memory	2 GB	2 GB	2 GB	2 GB
User memory	2 GB	8 GB	8 GB	2 GB
Available memory (user data)	1200 MB	1000 MB	1400 MB	1200 MB
SD/MMC Slot	-	-	-	-
CF Card Slot Typ II	-	-	-	-

SLIO
100V
200V
300S
500S
HMI
Teleservice
Starterkits
Safety
Solutions
Software
Accessories
Appendix

Panel PC Panel PC					
67P-PNJ0-EB	67S-PNL0-JB				
67P-PNL0-JB	67S-PNL0-JX				
67P-PNL0-JX					
67S-PNJ0-EB					

Order number	67P-PNJ0-EB	67P-PNL0-JB	67P-PNL0-JX	67S-PNJ0-EB
Time				
Real-time clock buffered	✓	✓	✓	✓
Clock buffered period (min.)	4 y	4 y	4 y	4 y
Type of buffering	lithium battery	lithium battery	lithium battery	lithium battery
Load time for 50% buffering period	-	-	-	-
Load time for 100% buffering period	-	-	-	-
Accuracy (max. deviation per day)	10 s	10 s	10 s	10 s
Operating controls				
Touchscreen	PCAP	PCAP	PCAP	PCAP
Keyboard	external via USB	external via USB	external via USB	external via USB
Mouse	external via USB	external via USB	external via USB	external via USB
Interfaces				
MPI, PROFIBUS-DP	-	-	-	-
MPI, PROFIBUS-DP connector	-	-	-	-
Serial, COM1	RS232 / RS422 / RS485	RS232 / RS422 / RS485	RS232 / RS422 / RS485	RS232 / RS422 / RS485
COM1 connector	Sub-D, 9-pin, male	Sub-D, 9-pin, male	Sub-D, 9-pin, male	Sub-D, 9-pin, male
Serial, COM2	RS232 / RS422 / RS485	RS232 / RS422 / RS485	RS232 / RS422 / RS485	RS232 / RS422 / RS485
COM2 connector	Sub-D, 9-pin, male	Sub-D, 9-pin, male	Sub-D, 9-pin, male	Sub-D, 9-pin, male
Number of USB-A interfaces	4	4	4	4
USB-A connector	USB-A (host)	USB-A (host)	USB-A (host)	USB-A (host)
Number of USB-B interfaces	-	-	-	-
USB-B connector	-	-	-	-
Number of ethernet interfaces	2	2	2	2
Ethernet	Ethernet 10/100/1000 MBit	Ethernet 10/100/1000 MBit	Ethernet 10/100/1000 MBit	Ethernet 10/100/1000 MBit
Ethernet connector	2 x RJ45	2 x RJ45	2 x RJ45	2 x RJ45
Integrated ethernet switch	-	-	-	-
Technical data power supply				
Power supply (rated value)	DC 24 V	DC 24 V	DC 24 V	DC 24 V
Power supply (permitted range)	DC 20.4...28.8 V	DC 20.4...28.8 V	DC 20.4...28.8 V	DC 20.4...28.8 V
Reverse polarity protection	✓	✓	✓	✓
Current consumption (no-load operation)	1.2 A	1.2 A	1.2 A	1.2 A
Current consumption (rated value)	1.3 A	1.3 A	1.3 A	1.3 A
Inrush current	1.3 A	1.3 A	1.3 A	1.3 A
I ² t	0.35 A ² s	0.35 A ² s	0.35 A ² s	0.35 A ² s
Power loss	32 W	32 W	32 W	32 W

Panel PC Panel PC					
67P-PNJ0-EB	67S-PNL0-JB				
67P-PNL0-JB	67S-PNL0-JX				
67P-PNL0-JX					
67S-PNJ0-EB					

Order number	67P-PNJ0-EB	67P-PNL0-JB	67P-PNL0-JX	67S-PNJ0-EB
Status information, alarms, diagnostics				
Supply voltage display	none	none	none	none
Mechanical data				
Housing / Protection type				
Material	coated aluminum steel plate	coated aluminum steel plate	coated aluminum steel plate	coated aluminum steel plate
Mounting	via integrated pivoted lever	via integrated pivoted lever	via integrated pivoted lever	via integrated pivoted lever
Protect type front side	IP 65	IP 65	IP 65	IP 65
Protect type back side	IP 20	IP 20	IP 20	IP 20
Dimensions				
Front panel	417.8 mm x 312.8 mm x 6.2 mm	417.8 mm x 312.8 mm x 6.2 mm	417.8 mm x 312.8 mm x 6.2 mm	562.4 mm x 382.4 mm x 6.7 mm
Rear panel	396 mm x 291 mm x 57.6 mm	396 mm x 291 mm x 57.6 mm	396 mm x 291 mm x 57.6 mm	542 mm x 362 mm x 54.2 mm
Installation cut-out				
Width	401 mm	401 mm	401 mm	547 mm
Height	296 mm	296 mm	296 mm	367 mm
Minimum	3 mm	3 mm	3 mm	3 mm
Maximum front panel thickness	12 mm	12 mm	12 mm	12 mm
Weight	6.2 kg	6.2 kg	6.2 kg	9.1 kg
Environmental conditions				
Operating temperature	0 °C to 50 °C	0 °C to 50 °C	0 °C to 50 °C	0 °C to 50 °C
Storage temperature	-20 °C to 75 °C	-20 °C to 75 °C	-20 °C to 75 °C	-20 °C to 75 °C
Certifications				
UL508 certification	yes	yes	yes	yes

Connections, Interfaces

Panel PC | Panel PC

67P-PNJ0-EB 67P-PNL0-JB 67P-PNL0-JX 67S-PNJ0-EB	67S-PNL0-JB 67S-PNL0-JX				
--	----------------------------	--	--	--	--

67P-PNJ0-EB



COM 1/2

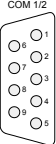

RS232/RS422/RS485

- ① DCD / TxD- / TxD-RxD-
- ② RxD / TxD+ / TxD+RxD+
- ③ TxD / RxD+ / reserve
- ④ DTR / RxD- / reserve
- ⑤ GND / GND / reserve
- ⑥ DSR / RTS- / reserve
- ⑦ RTS / RTS+ / reserve
- ⑧ CTS / CTS+ / reserve
- ⑨ RI (+5V) / CTS- / reserve (+12V)

VGA

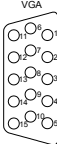

- ① red
- ② green
- ③ blue
- ④ n.c.
- ⑤ GND
- ⑥ GND
- ⑦ GND
- ⑧ GND
- ⑨ +5V

- ⑩ GND
- ⑪ n.c.
- ⑫ DDC data
- ⑬ HSYNC
- ⑭ VSYNC
- ⑮ DDC clock

Line out



- ① LOUT_R
- ② JD
- ③ NC
- ④ LOUT_L
- ⑤ GND

USB-A



- ① VCC
- ② DM
- ③ DP
- ④ GND

RJ45



- ① Tx+
- ② Tx-
- ③ Rx+
- ④ Rx-
- ⑤ -
- ⑥ -
- ⑦ -
- ⑧ -

DCIN12-30V

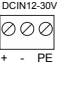

- + - PE

67P-PNL0-JB



COM 1/2

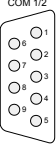

RS232/RS422/RS485

- ① DCD / TxD- / TxD-RxD-
- ② RxD / TxD+ / TxD+RxD+
- ③ TxD / RxD+ / reserve
- ④ DTR / RxD- / reserve
- ⑤ GND / GND / reserve
- ⑥ DSR / RTS- / reserve
- ⑦ RTS / RTS+ / reserve
- ⑧ CTS / CTS+ / reserve
- ⑨ RI (+5V) / CTS- / reserve (+12V)

VGA

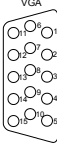

- ① red
- ② green
- ③ blue
- ④ n.c.
- ⑤ GND
- ⑥ GND
- ⑦ GND
- ⑧ GND
- ⑨ +5V

- ⑩ GND
- ⑪ n.c.
- ⑫ DDC data
- ⑬ HSYNC
- ⑭ VSYNC
- ⑮ DDC clock

Line out



- ① LOUT_R
- ② JD
- ③ NC
- ④ LOUT_L
- ⑤ GND

USB-A



- ① VCC
- ② DM
- ③ DP
- ④ GND

RJ45



- ① Tx+
- ② Tx-
- ③ Rx+
- ④ Rx-
- ⑤ -
- ⑥ -
- ⑦ -
- ⑧ -

DCIN12-30V

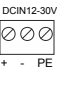

- + - PE

67P-PNL0-JX



COM 1/2

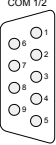

RS232/RS422/RS485

- ① DCD / TxD- / TxD-RxD-
- ② RxD / TxD+ / TxD+RxD+
- ③ TxD / RxD+ / reserve
- ④ DTR / RxD- / reserve
- ⑤ GND / GND / reserve
- ⑥ DSR / RTS- / reserve
- ⑦ RTS / RTS+ / reserve
- ⑧ CTS / CTS+ / reserve
- ⑨ RI (+5V) / CTS- / reserve (+12V)

VGA

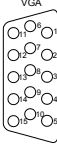

- ① red
- ② green
- ③ blue
- ④ n.c.
- ⑤ GND
- ⑥ GND
- ⑦ GND
- ⑧ GND
- ⑨ +5V

- ⑩ GND
- ⑪ n.c.
- ⑫ DDC data
- ⑬ HSYNC
- ⑭ VSYNC
- ⑮ DDC clock

Line out



- ① LOUT_R
- ② JD
- ③ NC
- ④ LOUT_L
- ⑤ GND

USB-A



- ① VCC
- ② DM
- ③ DP
- ④ GND

RJ45



- ① Tx+
- ② Tx-
- ③ Rx+
- ④ Rx-
- ⑤ -
- ⑥ -
- ⑦ -
- ⑧ -

DCIN12-30V

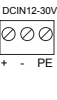

- + - PE

67S-PNJ0-EB



COM 1/2

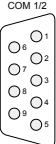

RS232/RS422/RS485

- ① DCD / TxD- / TxD-RxD-
- ② RxD / TxD+ / TxD+RxD+
- ③ TxD / RxD+ / reserve
- ④ DTR / RxD- / reserve
- ⑤ GND / GND / reserve
- ⑥ DSR / RTS- / reserve
- ⑦ RTS / RTS+ / reserve
- ⑧ CTS / CTS+ / reserve
- ⑨ RI (+5V) / CTS- / reserve (+12V)

VGA

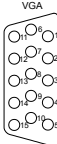

- ① red
- ② green
- ③ blue
- ④ n.c.
- ⑤ GND
- ⑥ GND
- ⑦ GND
- ⑧ GND
- ⑨ +5V

- ⑩ GND
- ⑪ n.c.
- ⑫ DDC data
- ⑬ HSYNC
- ⑭ VSYNC
- ⑮ DDC clock

Line out



- ① LOUT_R
- ② JD
- ③ NC
- ④ LOUT_L
- ⑤ GND

USB-A



- ① VCC
- ② DM
- ③ DP
- ④ GND

RJ45



- ① Tx+
- ② Tx-
- ③ Rx+
- ④ Rx-
- ⑤ -
- ⑥ -
- ⑦ -
- ⑧ -

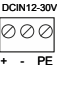

DCIN12-30V



- + - PE

Panel PC

Panel PC Panel PC					
67P-PNJ0-EB	67S-PNL0-JB				
67P-PNL0-JB	67S-PNL0-JX				
67P-PNL0-JX					
67S-PNJ0-EB					

Order number	67S-PNL0-JB	67S-PNL0-JX		
Figure				
Type	Panel PC PPC021 ES	Panel PC PPC021 ES		
General information				
Note	-	-		
Features	<ul style="list-style-type: none"> › Processor: Intel Atom D2550 dualcore @1,86 GHz › Work memory: 2 GB › Operating system and user memory: 8 GB › Memory card plug-in place: CFast › Interfaces: 2x Ethernet (10/100/1000), 4x USB 2.0, 2x serial (RS232,RS422/RS485), Audio out › Display: 21,5" › Incl. operating system Windows Embedded Standard 7 	<ul style="list-style-type: none"> › Processor: Intel Atom D2550 dualcore @1,86 GHz › Work memory: 2 GB › Operating system and user memory: 8 GB › Memory card plug-in place: CFast › Interfaces: 2x Ethernet (10/100/1000), 4x USB 2.0, 2x serial (RS232,RS422/RS485), Audio out › Display: 21,5" › Incl. operating system Windows Embedded Standard 7 		
Display				
Display size (diagonal)	21.5 "	21.5 "		
Display size (width)	478 mm	478 mm		
Display size (height)	269 mm	269 mm		
Resolution	1920 x 1080	1920 x 1080		
Aspect ratio	16:9	16:9		
Type of display	TFT color (16.7M colors)	TFT color (16.7M colors)		
MTBF Backlights (25°C)	50000 h	50000 h		
System properties				
Processor	Intel Atom Dualcore 1,86 GHz	Intel Atom Dualcore 1,86 GHz		
Operating system	Windows embedded Standard 7	Windows embedded Standard 7		
User software	Movicon 11 Win Standard	-		
Work memory	2 GB	2 GB		
User memory	8 GB	8 GB		
Available memory (user data)	1000 MB	1400 MB		
SD/MMC Slot	-	-		
CF Card Slot Typ II	-	-		

Panel PC Panel PC					
67P-PNJ0-EB	67S-PNL0-JB				
67P-PNL0-JB	67S-PNL0-JX				
67P-PNL0-JX					
67S-PNJ0-EB					

Order number	67S-PNL0-JB	67S-PNL0-JX		
Time				
Real-time clock buffered	✓	✓		
Clock buffered period (min.)	4 y	4 y		
Type of buffering	lithium battery	lithium battery		
Load time for 50% buffering period	-	-		
Load time for 100% buffering period	-	-		
Accuracy (max. deviation per day)	10 s	10 s		
Operating controls				
Touchscreen	PCAP	PCAP		
Keyboard	external via USB	external via USB		
Mouse	external via USB	external via USB		
Interfaces				
MPI, PROFIBUS-DP	-	-		
MPI, PROFIBUS-DP connector	-	-		
Serial, COM1	RS232 / RS422 / RS485	RS232 / RS422 / RS485		
COM1 connector	Sub-D, 9-pin, male	Sub-D, 9-pin, male		
Serial, COM2	RS232 / RS422 / RS485	RS232 / RS422 / RS485		
COM2 connector	Sub-D, 9-pin, male	Sub-D, 9-pin, male		
Number of USB-A interfaces	4	4		
USB-A connector	USB-A (host)	USB-A (host)		
Number of USB-B interfaces	-	-		
USB-B connector	-	-		
Number of ethernet interfaces	2	2		
Ethernet	Ethernet 10/100/1000 MBit	Ethernet 10/100/1000 MBit		
Ethernet connector	2 x RJ45	2 x RJ45		
Integrated ethernet switch	-	-		
Technical data power supply				
Power supply (rated value)	DC 24 V	DC 24 V		
Power supply (permitted range)	DC 20.4...28.8 V	DC 20.4...28.8 V		
Reverse polarity protection	✓	✓		
Current consumption (no-load operation)	1.2 A	1.2 A		
Current consumption (rated value)	1.3 A	1.3 A		
Inrush current	1.3 A	1.3 A		
I ² t	0.35 A ² s	0.35 A ² s		
Power loss	32 W	32 W		

SLIO
100V
200V
300S
500S
HMI
Teleservice
StarterKits
Safety
Solutions
Software
Accessories
Appendix

Panel PC Panel PC						
67P-PNJ0-EB	67S-PNL0-JB					
67P-PNL0-JB	67S-PNL0-JX					
67P-PNL0-JX						
67S-PNJ0-EB						



Order number	67S-PNL0-JB	67S-PNL0-JX		
Status information, alarms, diagnostics				
Supply voltage display	none	none		
Mechanical data				
Housing / Protection type				
Material	coated aluminum steel plate	coated aluminum steel plate		
Mounting	via integrated pivoted lever	via integrated pivoted lever		
Protect type front side	IP 65	IP 65		
Protect type back side	IP 20	IP 20		
Dimensions				
Front panel	562.4 mm x 382.4 mm x 6.7 mm	562.4 mm x 382.4 mm x 6.7 mm		
Rear panel	542 mm x 362 mm x 54.2 mm	542 mm x 362 mm x 54.2 mm		
Installation cut-out				
Width	547 mm	547 mm		
Height	367 mm	367 mm		
Minimum	3 mm	3 mm		
Maximum front panel thickness	12 mm	12 mm		
Weight	9.1 kg	9.1 kg		
Environmental conditions				
Operating temperature	0 °C to 50 °C	0 °C to 50 °C		
Storage temperature	-20 °C to 75 °C	-20 °C to 75 °C		
Certifications				
UL508 certification	yes	yes		

Connections, Interfaces

Panel PC | Panel PC

67P-PNJ0-EB 67P-PNL0-JB 67P-PNL0-JX 67S-PNJ0-EB	67S-PNL0-JB 67S-PNL0-JX					
--	----------------------------	--	--	--	--	--

67S-PNL0-JB

COM 1/2

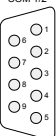

RS232/RS422/RS485

- ① DCD / TxD- / TxD-/RxD-
- ② RxD / TxD+ / TxD+/RxD+
- ③ TxD / RxD+ / reserve
- ④ DTR / RxD- / reserve
- ⑤ GND / GND / reserve
- ⑥ DSR / RTS- / reserve
- ⑦ RTS / RTS+ / reserve
- ⑧ CTS / CTS+ / reserve
- ⑨ RI (+5V) / CTS- / reserve (+12V)

VGA

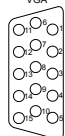

- ① red
- ② green
- ③ blue
- ④ n.c.
- ⑤ GND
- ⑥ GND
- ⑦ GND
- ⑧ GND
- ⑨ +5V

- ⑩ GND
- ⑪ n.c.
- ⑫ DDC data
- ⑬ HSYNC
- ⑭ VSYNC
- ⑮ DDC clock

Line out



- ① LOUT_R
- ② JD
- ③ NC
- ④ LOUT_L
- ⑤ GND
- ⑥ GND

USB-A



- ① VCC
- ② DM
- ③ DP
- ④ GND

RJ45





- ① Tx+
- ② Tx-
- ③ Rx+
- ④ Rx-
- ⑤ -
- ⑥ -
- ⑦ -
- ⑧ -
- ⑨ -
- ⑩ -

DCIN12-30V



- + - PE

67S-PNL0-JX

COM 1/2

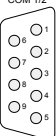

RS232/RS422/RS485

- ① DCD / TxD- / TxD-/RxD-
- ② RxD / TxD+ / TxD+/RxD+
- ③ TxD / RxD+ / reserve
- ④ DTR / RxD- / reserve
- ⑤ GND / GND / reserve
- ⑥ DSR / RTS- / reserve
- ⑦ RTS / RTS+ / reserve
- ⑧ CTS / CTS+ / reserve
- ⑨ RI (+5V) / CTS- / reserve (+12V)

VGA

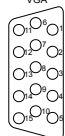

- ① red
- ② green
- ③ blue
- ④ n.c.
- ⑤ GND
- ⑥ GND
- ⑦ GND
- ⑧ GND
- ⑨ +5V

- ⑩ GND
- ⑪ n.c.
- ⑫ DDC data
- ⑬ HSYNC
- ⑭ VSYNC
- ⑮ DDC clock

Line out



- ① LOUT_R
- ② JD
- ③ NC
- ④ LOUT_L
- ⑤ GND
- ⑥ GND

USB-A



- ① VCC
- ② DM
- ③ DP
- ④ GND

RJ45



- ① Tx+
- ② Tx-
- ③ Rx+
- ④ Rx-
- ⑤ -
- ⑥ -
- ⑦ -
- ⑧ -
- ⑨ -
- ⑩ -

DCIN12-30V



- + - PE

HMI software



Structure and Function

The touch panel software and tools extend the capabilities of both the operating system as well as the visualization of Movicon and thus also the application possibilities of the touch panel.

Operating System

The VIPA Touch Panels are supplied together with the operating system Windows embedded CE 6.0. These worldwide-distributed operating systems guarantee a high degree of availability, flexibility and expandability.

Movicon-Runtime

The runtime version of Movicon provides VBA support, include a graphic interface, an extensive symbol and driver library as well as an automatic reconnect and data synchronization. In addition, various function libraries are available, such as the integration of intelligent peripherals and communication modules.

The use of the preinstalled runtime version of Movicon facilitate the immediate release of visualization projects.

Movicon-Editors

Movicon is a HMI/SCADA platforms with an open and flexible architecture for industrial automation, which allows the user vertical applications for visualization, data acquisition, logging as well as maintenance quickly and easily. Movicon with its graphically-intuitive interface and many integrated tools is easy to use for the operator.

Characteristics

- Java™ support
- Upgrade option to newer runtime versions
- Expansion of the existing run-time functionality
- Web server support
- Enlargement of the trend and archive server function

HMI software - Editors

Movicon®

Order number	SW614E1MB	SW614E1MAUB		
Type	Movicon11 Editor	MoviconX Editor		
General information				
Note	-	-		
Features	<ul style="list-style-type: none"> ▸ Movicon11 Editor for Windows CE projects, incl. USB dongle 	<ul style="list-style-type: none"> ▸ Upgrade to Movicon 11 		
Software attributes				
Premise (minimum)	Celeron 1.6 GHz o.ä., 512 MB RAM	Celeron 1.6 GHz o.ä., 512 MB RAM		
Premise (recommended)	Pentium IV 3 GHz, 1 GB RAM	Pentium IV 3 GHz, 1 GB RAM		
Target platform	Windows XP (SP3), Vista, 7 (32Bit/64Bit), 8 (32Bit/64Bit), Server 2003, 2008, 2008R2, 2012	Windows XP (SP3), Vista, 7 (32Bit/64Bit), 8 (32Bit/64Bit), Server 2003, 2008, 2008R2, 2012		
License model	single user license	single user license		

HMI software - Runtime

Movicon®

Order number	SW514S31B	SW514S33B	SW514S35B	SW514X11B1
Type	-	-	-	-
General information				
Note	-	-	-	-
Features	<ul style="list-style-type: none"> ▸ USB dongle, executable only on VIPA Panel PCs with Movicon basic license (128 IO bytes) ▸ Online upgrade, executable only on VIPA Panel PCs, expansion for a Movicon 11 Win Standard license, the number of the IO bytes has to correspond 	<ul style="list-style-type: none"> ▸ USB dongle, executable only on VIPA Panel PCs with Movicon basic license (512 IO bytes) ▸ Online upgrade, executable only on VIPA Panel PCs, expansion for a Movicon 11 Win Standard license, the number of the IO bytes has to correspond 	<ul style="list-style-type: none"> ▸ USB dongle, executable only on VIPA Panel PCs with Movicon basic license (2048 IO bytes) ▸ Online upgrade, executable only on VIPA Panel PCs, expansion for a Movicon 11 Win Standard license, the number of the IO bytes has to correspond 	<ul style="list-style-type: none"> ▸ Expansion by 1 web client for Movicon version 11.x for Windows up to 128 IO bytes ▸ Online upgrade, executable only on VIPA Panel PCs, expansion for a Movicon 11 Win Standard license, the number of the IO bytes has to correspond
Software attributes				
Premise (minimum)	-	-	-	-
Premise (recommended)	-	-	-	-
Target platform	-	-	-	-
License model	single user license	single user license	single user license	single user license

Order number	SW514X11B2	SW514X13B1	SW514X13B2	SW514X15B1
Type	-	-	-	-
General information				
Note	-	-	-	-
Features	<ul style="list-style-type: none"> ▸ Online upgrade, executable only on VIPA Panel PCs, expansion for a Movicon 11 Win Standard license, the number of the IO bytes has to correspond ▸ Expansion by 2 web clients for Movicon version 11.x for Windows up to 128 IO bytes 	<ul style="list-style-type: none"> ▸ Online upgrade, executable only on VIPA Panel PCs, expansion for a Movicon 11 Win Standard license, the number of the IO bytes has to correspond ▸ Expansion by 1 web client for Movicon version 11.x for Windows up to 512 IO bytes 	<ul style="list-style-type: none"> ▸ Online upgrade, executable only on VIPA Panel PCs, expansion for a Movicon 11 Win Standard license, the number of the IO bytes has to correspond ▸ Expansion by 2 web clients for Movicon version 11.x for Windows up to 512 IO bytes 	<ul style="list-style-type: none"> ▸ Online upgrade, executable only on VIPA Panel PCs, expansion for a Movicon 11 Win Standard license, the number of the IO bytes has to correspond ▸ Expansion by 1 web client for Movicon version 11.x for Windows up to 2048 IO bytes
Software attributes				
Premise (minimum)	-	-	-	-
Premise (recommended)	-	-	-	-
Target platform	-	-	-	-
License model	single user license	single user license	single user license	single user license

Order number	SW514X15B2			
Type	-			
General information				
Note	-			
Features	<ul style="list-style-type: none"> ▸ Online upgrade, executable only on VIPA Panel PCs, expansion for a Movicon 11 Win Standard license, the number of the IO bytes has to correspond ▸ Expansion by 2 web clients for Movicon version 11.x for Windows up to 2048 IO bytes 			
Software attributes				
Premise (minimum)	-			
Premise (recommended)	-			
Target platform	-			
License model	single user license			

HMI accessories



Structure and Function

System accessories enable and expand the use of the system and facilitate starting.

Memory Expansion

Standard Memory Type Compact Flash (CF) or Secure Disk (SD) can be used to expand the internal memory.

Cables

Accessories, such as USB and Ethernet programming cables, OP/AG cables with diagnostic connector or peripheral extension cables, as well as an extensive number of different protective films, support the versatile use of the systems.

Manuals

The technical documentation of the respective modules encompasses various manuals with the necessary hardware and programming information, detailed descriptions of each module, and instructions for structure and assembly.

Memory modules for Touch Panels



Order number	Type	Description	Note
574-2AH00	Compact Flash (CF) 1GByte	for VIPA professional Panels	
574-2AI00	Compact Flash (CF) 2GByte	for VIPA professional Panels	
953-1SI00	Secure Disc (SD) 2GByte	for VIPA eco and professional Panels	

Protective foil

Order number	Type	Description	Note
574-1AE01	Protective foil TP606	for professional Panels 6.5", 10 pieces	
574-1AF01	Protective foil TP608	for professional Panels 8.4", 10 pieces	
574-1AG01	Protective foil TP610	for professional Panels 10.4", 10 pieces	
574-1AH10	Protective foil TP612	for professional Panels 12.1", 10 pieces	
574-1BS01	Protective foil TP605	for professional Panels 5.7", 10 pieces	
574-1BC01	Protective foil TP605	for professional Panels 5.7", 10 pieces	

Cables



Order number	Type	Description	Note
670-0KB20	Ethernet programming cable	for Touch Panels with Movicon 3.0 m	
670-0KB00	OP/AG cable 0°/90° with PU/Diagnostic port	for VIPA CC 03, OP 03, TD 03	
670-0KB01	OP/AG cable 90°/90° with PU/Diagnostic port	PU-/Diagnostic port, 2.5 m	
660-0KB00	Periphery expansion cable CC 03	for up to 4 expansion modules EM 123 or Sytem 200V modules, 0.5 m	
950-0KB50	PC/AG programming cable	MPI cable with PU-/Diagnostic port, 2.5 m; use as PC/AG or TP/AG	

Manuals and operating instructions



Order number	Title	Contents	Language
HB116D	Manual Line displays - Compendium, German	HB116D_CC incl. operations list, HB116D_OP, HB116D_TD	DE
HB116E	Manual Line displays - Compendium, English	HB116E_CC incl. operations list, HB116E_OP, HB116E_TD	EN
HB116D_CC03	Manual Line displays - German	Commander Compact CC 03, incl. operations list	DE
HB116E_CC03	Manual Line displays - English	Commander Compact CC 03, incl. operations list	EN
HB116D_OP03	Manual Line displays - German	Operator Panel OP 03	DE
HB116E_OP03	Manual Line displays - English	Operator Panel OP 03	EN
HB116D_TD03	Manual Line displays - German	Text Display TD 03	DE
HB116E_TD03	Manual Line displays - English	Text Display TD 03	EN
HB160D_TP_X8	Manual Touch Panel, XScale 800 MHz - Compendium, German	Manual Touch Panel, XScale 800 MHz - Compendium, German	DE
HB160E_TP_X8	Manual Touch Panel, XScale 800 MHz - Compendium, English	Manual Touch Panel, XScale 800 MHz - Compendium, English	EN
HB160D_TP-ECO	Manual Touch Panel, ARM11 533MHz - Compendium, German	Manual Touch Panel, ARM11 533MHz - Compendium, German	DE
HB160E_TP-ECO	Manual Touch Panel, ARM11 533MHz - Compendium, English	Manual Touch Panel, ARM11 533MHz - Compendium, English	EN
HB160D_PPC	Manual Panel PC PPC	Compendium, German	DE
HB160E_PPC	Manual Panel PC PPC	Compendium, English	EN

At a glance

Teleservice

640



| Teleservice

Teleservice



As demonstrated by numerous studies, up to 70% of the maintenance costs can be saved by preventive maintenance. A useful tool for this is the teleservice that enables a continuous monitoring and maintenance of the systems. For this reason with the VIPA teleservice modules we offer a modern and intelligent kind of teleservice for the different types of transmission. Whether on the conventional way via analog or ISDN line or via broadband connections as ADSL and HSUPA (mobile communications) VIPA offers here the complete product range on teleservice modules too. The communication to your automatization modules is established by MPI or PROFIBUS or via the Ethernet interface, which belongs to each of our devices as standard. The configuration of the VIPA teleservice modules is performed via a web browser. Additional software or the like is not required.

Beside the robust hardware, which shines with the usual VIPA interface variety, VIPA offers also a free service called Talk2M. Via this service you are able to establish a save connection to your construction within seconds, regardless of whether they are communicating via mobile phone or a line.

Teleservice of controllers, HMIs, frequency converters, roboters, IPCs etc. are not an impossible challenge for us. With the VIPA Teleservice modules, you have a perfectly balanced combination of hardware and software.

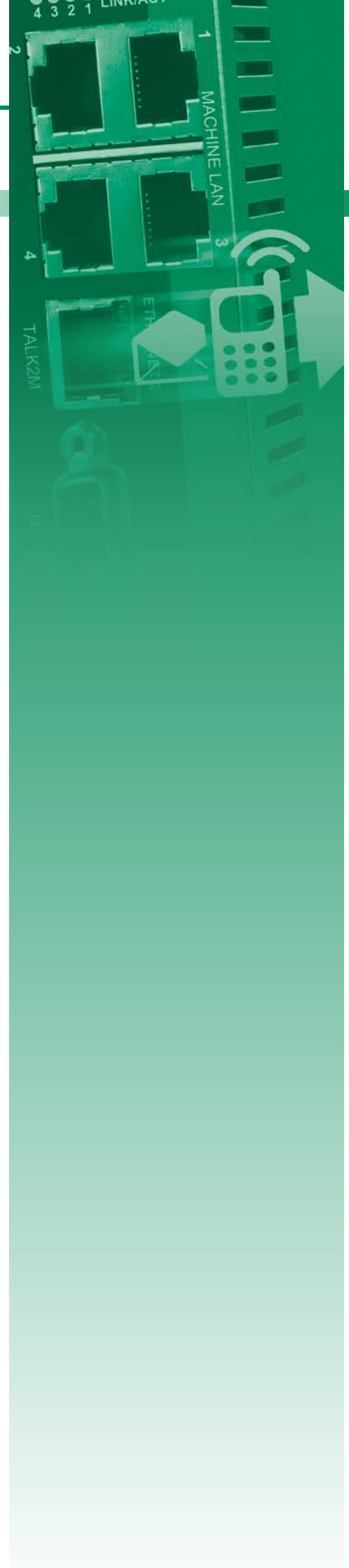



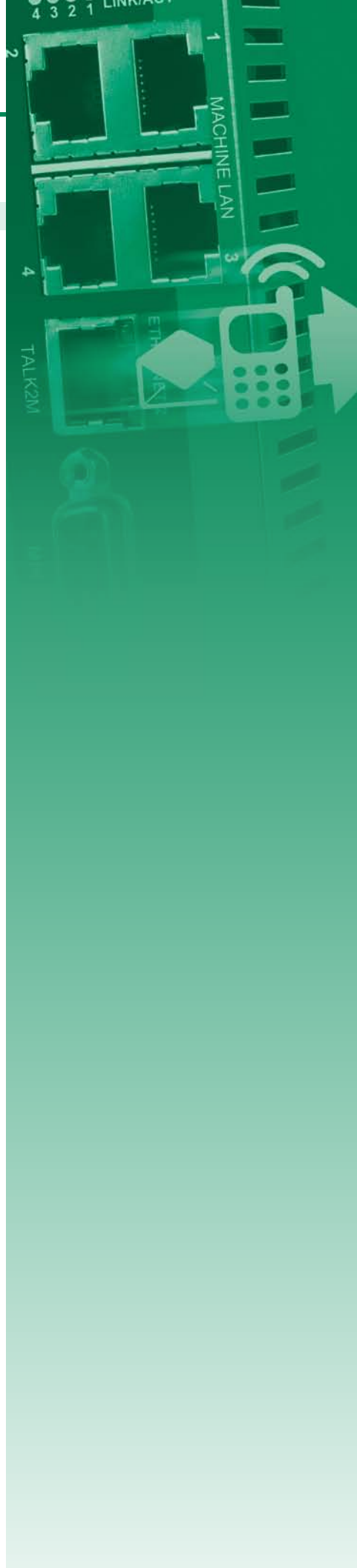

Overview

Order no.	Name/Description	Page
Teleservice modules		
900-2E631	TM-E ISDN Router VPN ▶ For direct point to point teleservice via ISDN line or Talk2M & VPN ▶ 1x RS485 MPI-/PROFIBUS-DP interface ▶ 1x LAN RJ45 Ethernet interface ▶ 1x integrated ISDN modem	642
900-2E641	TM-E Analog Router VPN ▶ For direct point to point teleservice via analog line or Talk2M & VPN ▶ 1x RS485 MPI-/PROFIBUS-DP interface ▶ 1x LAN RJ45 Ethernet interface ▶ 1x integrated PSTN modem	642
900-2E651	TM-E GSM/GPRS Router VPN ▶ For direct point to point teleservice via cellular network or Talk2M & VPN ▶ 1x RS485 MPI-/PROFIBUS-DP interface ▶ 1x LAN RJ45 Ethernet interface ▶ 1x integrated GSM/GPRS (quad-band) modem ▶ Please order antenna separately!	642
900-2H611	TM-H Router VPN ▶ For teleservice through a broadband connection (ADSL) via Talk2M & VPN ▶ 1x RS485 MPI-/PROFIBUS-DP interface ▶ 4x LAN RJ45 Ethernet interface ▶ 1x WAN RJ45 Ethernet interface	642
900-2H681	TM-H HSDPA Router VPN ▶ For teleservice through a mobile connection (GPRS/EDGE/UMTS/HSUPA) via Talk2M & VPN ▶ 1x RS485 MPI-/PROFIBUS-DP interface ▶ 4x LAN RJ45 Ethernet interface ▶ 1x WAN RJ45 Ethernet interface ▶ 1x integrated HSDPA/HSUPA modem (QB)	644
900-2C610	TM-C Router ▶ For sheer teleservice through broadband connection (ADSL) via Talk2M ▶ 1x RS485 MPI-/PROFIBUS-DP interface ▶ 4x LAN RJ45 Ethernet interface ▶ 1x WAN RJ45 Ethernet interface	644



Teleservice modules

Teleservice Teleservice modules					
900-2E631	900-2H681				
900-2E641	900-2C610				
900-2E651					
900-2H611					



Order number	900-2E631	900-2E641	900-2E651	900-2H611
Figure				
Type	TM-E ISDN Router - VPN	TM-E Analog Router - VPN	TM-E GSM/GPRS Router quad-band - VPN	TM-H Router VPN
General information				
Note	-	-	-	-
Features	<ul style="list-style-type: none"> For direct point to point teleservice via ISDN line or Talk2M & VPN 1x RS485 MPI-/PROFIBUS-DP interface 1x LAN RJ45 Ethernet interface 1x integrated ISDN modem 	<ul style="list-style-type: none"> For direct point to point teleservice via analog line or Talk2M & VPN 1x RS485 MPI-/PROFIBUS-DP interface 1x LAN RJ45 Ethernet interface 1x integrated PSTN modem 	<ul style="list-style-type: none"> For direct point to point teleservice via cellular network or Talk2M & VPN 1x RS485 MPI-/PROFIBUS-DP interface 1x LAN RJ45 Ethernet interface 1x integrated GSM/GPRS (quad-band) modem Please order antenna separately! 	<ul style="list-style-type: none"> For teleservice through a broadband connection (ADSL) via Talk2M & VPN 1x RS485 MPI-/PROFIBUS-DP interface 4x LAN RJ45 Ethernet interface 1x WAN RJ45 Ethernet interface
Inputs and outputs				
Inputs	1 DI: 0/24 V DC, isolated	1 DI: 0/24 V DC, isolated	1 DI: 0/24 V DC, isolated	1 DI: 0/24 V DC, isolated
Outputs	1 DO: open drain, max. 200 mA at DC 30 V	1 DO: open drain, max. 200 mA at DC 30 V	1 DO: open drain, max. 200 mA at DC 30 V	1 DO: open drain, max. 200 mA at DC 30 V
Communication				
serial port	MPI/PROFIBUS, isolated, up to 12 MBit/s	MPI/PROFIBUS, isolated, up to 12 MBit/s	MPI/PROFIBUS, isolated, up to 12 MBit/s	MPI/PROFIBUS, isolated, up to 12 MBit/s
LAN	1 x RJ45, 10/100 MBit/s	1 x RJ45, 10/100 MBit/s	1 x RJ45, 10/100 MBit/s	4 x RJ45, 10/100 MBit/s Switch
WAN	-	-	-	1 x RJ45, 10/100 MBit/s
Modem type	ISDN	PSTN / analog	GSM/GPRS Quadband	-
Router				
Router functions	<ul style="list-style-type: none"> IP-Forwarding IP-Filter NAT Port-Forwarding Routing Table DHCP-Client 	<ul style="list-style-type: none"> IP-Forwarding IP-Filter NAT Port-Forwarding Routing Table DHCP-Client 	<ul style="list-style-type: none"> IP-Forwarding IP-Filter NAT Port-Forwarding Routing Table DHCP-Client 	<ul style="list-style-type: none"> IP-Forwarding IP-Filter NAT Port-Forwarding Routing Table DHCP-Client
RAS	<ul style="list-style-type: none"> PPP Dial-In PPP Dial-Out Call-Back 	<ul style="list-style-type: none"> PPP Dial-In PPP Dial-Out Call-Back 	<ul style="list-style-type: none"> PPP Dial-In PPP Dial-Out Call-Back 	<ul style="list-style-type: none"> PPP Dial-In PPP Dial-Out Call-Back

Teleservice Teleservice modules						
900-2E631	900-2H681					
900-2E641	900-2C610					
900-2E651						
900-2H611						

Order number	900-2E631	900-2E641	900-2E651	900-2H611
VPN				
VPN mode	Open VPN 2.0, Client/Server	Open VPN 2.0, Client/Server	Open VPN 2.0, Client/Server	Open VPN 2.0, Client/Server
Talk2M	✓	✓	✓	✓
Gateway protocols	<ul style="list-style-type: none"> › MPI › PPI › PROFIBUS › ISO TCP › Modbus TCP 	<ul style="list-style-type: none"> › MPI › PPI › PROFIBUS › ISO TCP › Modbus TCP 	<ul style="list-style-type: none"> › MPI › PPI › PROFIBUS › ISO TCP › Modbus TCP 	<ul style="list-style-type: none"> › MPI › PPI › PROFIBUS › ISO TCP › Modbus TCP
Services				
Server services	<ul style="list-style-type: none"> › FTP › HTTP 	<ul style="list-style-type: none"> › FTP › HTTP 	<ul style="list-style-type: none"> › FTP › HTTP 	<ul style="list-style-type: none"> › FTP › HTTP
Client Services	<ul style="list-style-type: none"> › FTP › SMTP › NTP › DYNDNS › SNMP 	<ul style="list-style-type: none"> › FTP › SMTP › NTP › DYNDNS › SNMP 	<ul style="list-style-type: none"> › FTP › SMTP › NTP › DYNDNS › SNMP 	<ul style="list-style-type: none"> › FTP › SMTP › NTP › DYNDNS › SNMP
Data management				
Custom Website	✓	✓	✓	✓
Project	web interface	web interface	web interface	web interface
Integrated protocols	<ul style="list-style-type: none"> › MPI › PPI › PROFIBUS › ISO TCP › Modbus TCP 	<ul style="list-style-type: none"> › MPI › PPI › PROFIBUS › ISO TCP › Modbus TCP 	<ul style="list-style-type: none"> › MPI › PPI › PROFIBUS › ISO TCP › Modbus TCP 	<ul style="list-style-type: none"> › MPI › PPI › PROFIBUS › ISO TCP › Modbus TCP
Interrupts				
Alarm message	<ul style="list-style-type: none"> › EMail › SMS › SNMP › FTP 	<ul style="list-style-type: none"> › EMail › SMS › SNMP › FTP 	<ul style="list-style-type: none"> › EMail › SMS › SNMP › FTP 	<ul style="list-style-type: none"> › EMail › SMS › SNMP › FTP
Alarm	<ul style="list-style-type: none"> › EMail › Hardware I/O › SMS › PLC-variables › SNMP › system variables › FTP 	<ul style="list-style-type: none"> › EMail › Hardware I/O › SMS › PLC-variables › SNMP › system variables › FTP 	<ul style="list-style-type: none"> › EMail › Hardware I/O › SMS › PLC-variables › SNMP › system variables › FTP 	<ul style="list-style-type: none"> › EMail › Hardware I/O › SMS › PLC-variables › SNMP › system variables › FTP
Housing				
Material	-	-	-	-
Mounting	Profile rail 35 mm	Profile rail 35 mm	Profile rail 35 mm	Profile rail 35 mm
Mechanical data				
Dimensions (WxHxD)	39 mm x 129 mm x 108 mm	39 mm x 129 mm x 108 mm	39 mm x 129 mm x 108 mm	39 mm x 129 mm x 108 mm
Weight	400 g	400 g	400 g	410 g
Environmental conditions				
Operating temperature	0 °C to 50 °C	0 °C to 50 °C	-20 °C to 70 °C	-20 °C to 70 °C
Storage temperature	-25 °C to 70 °C	-25 °C to 70 °C	-25 °C to 70 °C	-25 °C to 70 °C
Certifications				
UL508 certification	-	-	-	-

Teleservice modules

Teleservice Teleservice modules						
900-2E631	900-2H681					
900-2E641	900-2C610					
900-2E651						
900-2H611						

Order number	900-2H681	900-2C610		
Figure				
Type	TM-H GSM/HSUPA Router VPN	TM-C Router		
General information				
Note	-	-		
Features	<ul style="list-style-type: none"> ▸ For teleservice through a mobile connection (GPRS/EDGE/UMTS/HSUPA) via Talk2M & VPN ▸ 1x RS485 MPI-/PROFIBUS-DP interface ▸ 4x LAN RJ45 Ethernet interface ▸ 1x WAN RJ45 Ethernet interface ▸ 1x integrated HSDPA/HSUPA modem (QB) 	<ul style="list-style-type: none"> ▸ For sheer teleservice through broadband connection (ADSL) via Talk2M ▸ 1x RS485 MPI-/PROFIBUS-DP interface ▸ 4x LAN RJ45 Ethernet interface ▸ 1x WAN RJ45 Ethernet interface 		
Inputs and outputs				
Inputs	1 DI: 0/24 V DC, isolated	1 DI: 0/24 V DC, isolated		
Outputs	1 DO: open drain, max. 200 mA at DC 30 V	1 DO: open drain, max. 200 mA at DC 30 V		
Communication				
serial port	MPI/PROFIBUS, isolated, up to 12 MBit/s	MPI/PROFIBUS, isolated, up to 12 MBit/s		
LAN	4 x RJ45, 10/100 MBit/s Switch	4 x RJ45, 10/100 MBit/s Switch		
WAN	1 x RJ45, 10/100 MBit/s	1 x RJ45, 10/100 MBit/s		
Modem type	HSUPA	-		
Router				
Router functions	<ul style="list-style-type: none"> ▸ IP-Forwarding ▸ IP-Filter ▸ NAT ▸ Port-Forwarding ▸ Routing Table ▸ DHCP-Client 	▸ Talk2M		
RAS	<ul style="list-style-type: none"> ▸ PPP Dial-In ▸ PPP Dial-Out ▸ Call-Back 	▸ -		

Teleservice Teleservice modules						
900-2E631	900-2H681					
900-2E641	900-2C610					
900-2E651						
900-2H611						

Order number	900-2H681	900-2C610		
VPN				
VPN mode	Open VPN 2.0, Client/Server	-		
Talk2M	✓	✓		
Gateway protocols	<ul style="list-style-type: none"> › MPI › PPI › PROFIBUS › ISO TCP › Modbus TCP 	› -		
Services				
Server services	<ul style="list-style-type: none"> › FTP › HTTP 	<ul style="list-style-type: none"> › FTP › HTTP 		
Client Services	<ul style="list-style-type: none"> › FTP › SMTP › NTP › DYNDNS › SNMP 	› -		
Data management				
Custom Website	✓	✓		
Project	web interface	web interface		
Integrated protocols	<ul style="list-style-type: none"> › MPI › PPI › PROFIBUS › ISO TCP › Modbus TCP 	› -		
Interrupts				
Alarm message	<ul style="list-style-type: none"> › EMail › SMS › SNMP › FTP 	› -		
Alarm	<ul style="list-style-type: none"> › EMail › Hardware I/O › SMS › PLC-variables › SNMP › system variables › FTP 	› -		
Housing				
Material	-	-		
Mounting	Profile rail 35 mm	Profile rail 35 mm		
Mechanical data				
Dimensions (WxHxD)	39 mm x 129 mm x 108 mm	39 mm x 129 mm x 108 mm		
Weight	480 g	410 g		
Environmental conditions				
Operating temperature	-20 °C to 70 °C	-20 °C to 70 °C		
Storage temperature	-25 °C to 70 °C	-25 °C to 70 °C		
Certifications				
UL508 certification	-	-		

At a glance

StarterKits

648



| StarterKits

StarterKits



Structure and concept

The VIPA StarterKits are designed to allow newcomers immediate entry into the main product groups of the VIPA scope of supply by means of a complete product set. With this, it should be easier for the user to decide on new system configurations, in which he can first test the technology with the StarterKits and thereby save costs. The products included in the StarterKits are significantly subsidized, so that we can make possible a cost-effective introduction for every user. Depending on the product category the StarterKits include all hardware components required for the operational setup as well as some of the programming and parameterization software required for the unit configuration and/or the device master file (GSD). For transportation and presentation all components of the StarterKits are in a robust transport case.

300S, SPEED7 technology for the highest performance:

- › **StarterKits with the compact CPUs 312SC, 313SC or 313SC/DPM:** Each StarterKit comprises a 300SC CPU and a suitable front connector for the connection of the in- and output channels integrated in the CPU, the programming software WinPLC7 and a programming cable.

Technologie-StarterKits:

- › **Technologie StarterKit 1 PROFINET:** The StarterKit includes the SPEED7 PROFINET Eco CPU 315, the SLIO PROFINET I/O slave 053-1PN00, the SLIO potential distribution module 001-1BA20 together with different digital and analog in-/output modules and a PROFINET cable incl. two PROFINET plugs and a 35mm profile rail 140mm.
- › **Technologie StarterKit 2 EtherCAT:** The StarterKit includes the SPEED7 EtherCAT CPU 315-4EC12, the SLIO EtherCAT slave 053-1EC00, the SLIO potential distribution module 001-1BA20 together with different digital and analog input/output modules and an EtherCAT cable incl. two EtherCAT plugs and a 35mm profile rail 140mm.



SLIO StarterKits:

- ▶ **SLIO StarterKit IM053DP:** The StarterKit includes a SLIO PROFIBUS DP slave 053-1DP00, a SLIO potential distribution module 001-1BA20, different digital and analog in-/output modules, a PROFIBUS cable with 1m length incl. two PB plugs and a 35mm profile rail with a length of 140mm and a SLIO USB stick with GSD file, manual, catalog (German/English) and example programs.
- ▶ **SLIO CPU-StarterKit:** The StarterKit includes a SLIO CPU 015-CEFPR00 with PROFINET controller, the SLIO potential distribution module 021-1BA20, different digital and analog in-/output modules and a PROFINET cable with a length of 1m incl. 2 PROFINET plugs and a 35mm profile rail with a length of 227mm.

Performance and deployment

The StarterKits are assembled so that they are ready for use by the accessories and software included and also allow new users a quick start into the application. The combination of the single controller components and the accessories allows a practical and variable setup without additional parts. The robust transport case, which is supplied with each StarterKit, protects the single components from mechanical damage even with repeated use, for example during presentations.

Features

The hardware components included in the StarterKit are identical to the components which are available separately and perform in the same way. In this respect, the data given in the documentation and in this catalog apply to the components of the StarterKit.

Communication

In particular, the purpose of the two technology StarterKits for PROFINET and EtherCAT is to give the user an understanding of modern PROFINET or EtherCAT communication and to allow him to try it out in practice. Here our support team will gladly help you with the first steps, even if you entering new territory.

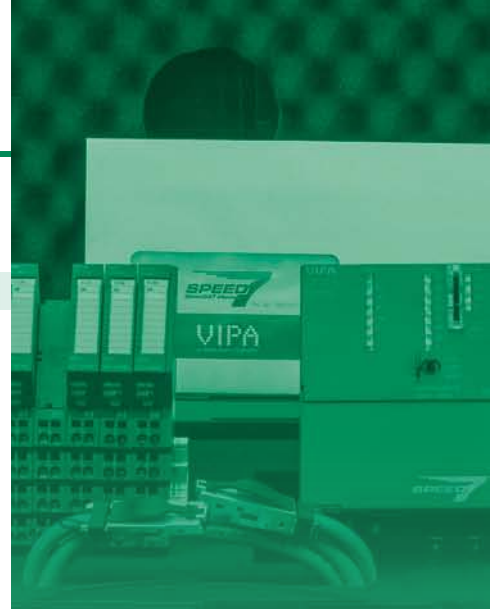

Overview

Order no.	Name/Description
300S	
800-7DK11	CPU 312SC - SPEED7 technology ▶ contains ▶ 1x 312-5BE13 CPU312SC ▶ 1x 392-1AM00 front connector ▶ 1x SW873 WINPLC7 ▶ 1x CAT6 cable 2m green ▶ 1x case
800-7DK21	CPU 313SC - SPEED7 technology ▶ contains ▶ 1x 313-5BF13 CPU313SC ▶ 2x 392-1AM00 front connectors ▶ 1x SW873 WINPLC7 ▶ 1x CAT6 cable 2m green ▶ 1x case
800-7DK31	CPU 313SC/DPM - SPEED7 technology ▶ contains ▶ 1x 313-6CF13 CPU313SC/DPM ▶ 1x 392-1AM00 front connector ▶ 1x SW873 WINPLC7 ▶ 1x CAT6 cable 2m green ▶ 1x case
Technologie	
800-5DK10	Technology Starter-Kit 1 - PROFINET ▶ contains ▶ 1x 950-0KD10 PN/EC cable 1m incl. 2x PN/EC connectors (972-0PN00 + 830-0PC00) ▶ 1x 35mm profile rail 140mm ▶ 1x case ▶ 1x 315-4PN33 CPU 315SN/PN ECO ▶ 1x 053-1PN00 IM 053PN - PROFINET IO Slave ▶ 1x 001-1BA20 CM 001 potential distribution module (4xDC24V, 4xDC0V) ▶ 1x 021-1BF00 SM 021 digital input (DI 8xDC 24V) ▶ 1x 021-1BD00 SM 021 digital input (DI 4xDC 24V) ▶ 1x 022-1BD00 SM 022 digital output (DO 4xDC 24V, 0,5A) ▶ 1x 031-1BB30 SM 031 analog input (AI 2x12Bit, U) ▶ 1x 032-1BB30 SM 032 analog output (AO 2x12Bit, U)
800-5DK20	Technology Starter-Kit 2- ETHERCAT ▶ contains ▶ 1x 950-0KD10 PN/EC cable 1m incl. 2x PN/EC connectors (972-0PN00 + 830-0PC00) ▶ 1x 35mm profile rail 140mm ▶ 1x case ▶ 1x 315-4EC12 CPU 315SN/EC ▶ 1x 053-1EC00 IM 053EC - EtherCAT slave ▶ 1x 001-1BA20 CM 001 potential distribution module (4xDC24V, 4xDC0V) ▶ 1x 021-1BF00 SM 021 digital input (DI 8xDC 24V) ▶ 1x 021-1BD00 SM 021 digital input (DI 4xDC 24V) ▶ 1x 022-1BD00 SM 022 digital output (DO 4xDC 24V, 0,5A) ▶ 1x 031-1BB30 SM 031 analog input (AI 2x12Bit, U) ▶ 1x 032-1BB30 SM 032 analog output (AO 2x12Bit, U)



Overview

Order no.	Name/Description
SLIO	
800-1DK10	<p>SLIO Starter-Kit 1- IM053DP</p> <ul style="list-style-type: none"> › contains › 1x 35 mm profile rail 140mm › 1x SLIO USB Stick (cont. GSD files, manual, catalog (German/English), example programs) › 1x case › 1x 053-1DP00 IM 053DP - Profibus DP slave › 1x 001-1BA20 CM 001 potential distribution module (4xDC24V, 4xDC0V) › 1x 021-1BF00 SM 021 digital input (DI 8xDC 24V) › 1x 021-1BD00 SM 021 digital input (DI 4xDC 24V) › 1x 022-1BD00 SM 022 digital output (DO 4xDC 24V, 0,5A) › 1x 031-1BB30 SM 031 analog input (AI 2x12Bit, U) › 1x 032-1BB30 SM 032 analog output (AO 2x12Bit, U) › 1x 950-0KD00 Profibus cable 1m incl. 2x PB connectors (972-ODP01 + 972-ODP10)
800-1DK50	<p>SLIO CPU Starter-Kit - incl. PROFINET Controller</p> <ul style="list-style-type: none"> › contains › 1x 35mm profile rail 227mm › 1x case › 1x 015-CEFP00 SLIO-CPU 015 › 1x 001-1BA20 CM 001 potential distribution module (4xDC24V, 4xDC0V) › 1x 021-1BF00 SM 021 digital input (DI 8xDC 24V) › 1x 021-1BD00 SM 021 digital input (DI 4xDC 24V) › 1x 022-1BD00 SM 022 digital output (DO 4xDC 24V, 0,5A) › 1x 031-1BB30 SM 031 analog input (AI 2x12Bit, U) › 1x 032-1BB30 SM 032 analog output (AO 2x12Bit, U) › 1x 950-0KD10 PN/EC cable 1m incl. 2x PN/EC connectors (972-0PN00 + 830-0PC00)

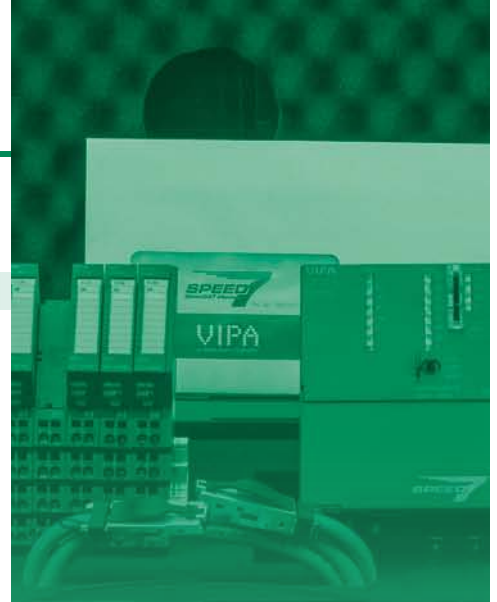



At a glance

System description Safety
Accessories

654
662



| Safety

System description Safety

Structure and concept

samosPRO is a fast, compact, modular safety controller for monitoring and controlling mechanical and system engineering applications.

The system enables complete and economic safety solutions that are more flexible than conventional relay technology.

The graphic device configuration and a functional diagram editor with extensive certified function block library ensure convenient and clear programming.

The modular design also allows expansion at a later stage and therefore flexible planning with fewer module variations. Up to 12 input and output expansion modules each with a width of 22.5 mm can be connected to a controller module. In this way 8 to 96 safe inputs and 4 to 48 safe outputs can be implemented.

The safety control system samosPRO is certified in accordance with EN 61508 to SIL 3, EN 62061 to SIL CL 3 and in accordance with EN ISO 13849-1:2006 up to Performance Level e/category 4. This covers the requirements of mechanical and system engineering applications.

It is mounted on a 35mm profile rail.



Performance and deployment

samosPRO allows the implementation of compact, fast and modular safety solutions for applications in mechanical and system engineering.

Programming

The programming is carried out with the software samosPLAN that is available in the download area of the VIPA homepage.

The programming software supports you during programming via a graphic device configuration and an intuitively easy to operate functional diagram editor. In the certified function block library there are standard logic blocks AND, OR, NOT, XNOR, XOR as well as application specific logic blocks like emergency stop, two-hand, muting, pressing, mode selector, reset and re-start. Up to 255 of these logic blocks are deployable in a project.

Memory

The system configuration including the system programs of the entire samosPRO systems is only stored in the program removable storage SP memory. This offers the advantage that the samosPRO system does not have to be reconfigured after the replacement of the connection modules.

Communication

Up to four samosPRO controller modules can be safely networked via the EFI interface. The connection with the standard VIPA controller is made via fieldbus gateways for PROFIBUS or PROFINET. The integration into other networks is made via gateways for CANopen, Modbus/TCP and Ethernet/IP. Up to two gateways can be connected to a controller module. The signal status (variables) can be replaced

bi-directionally via these gateways. Gateways that are based on Ethernet additionally allow an online access including programming and remote maintenance.

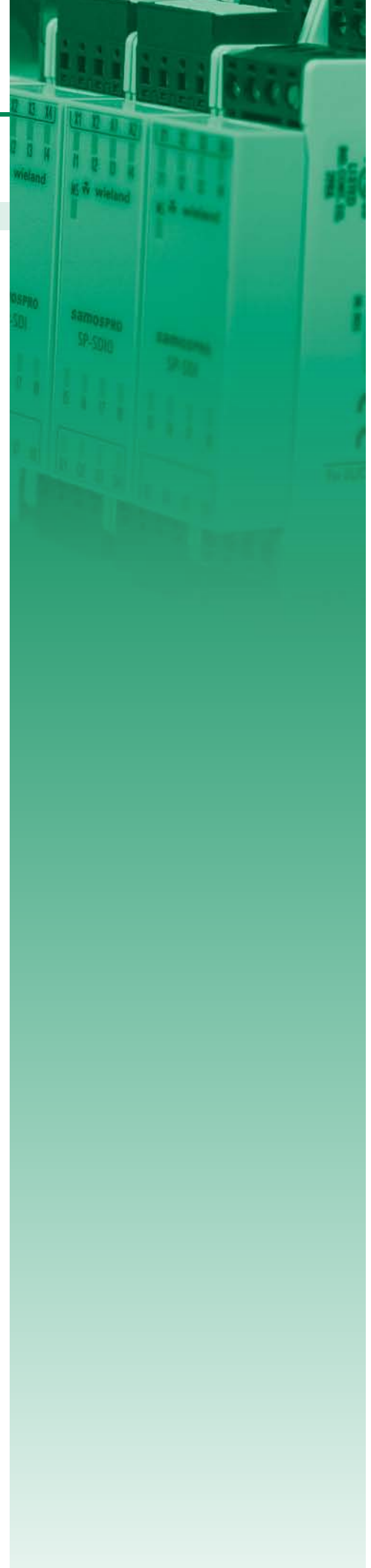



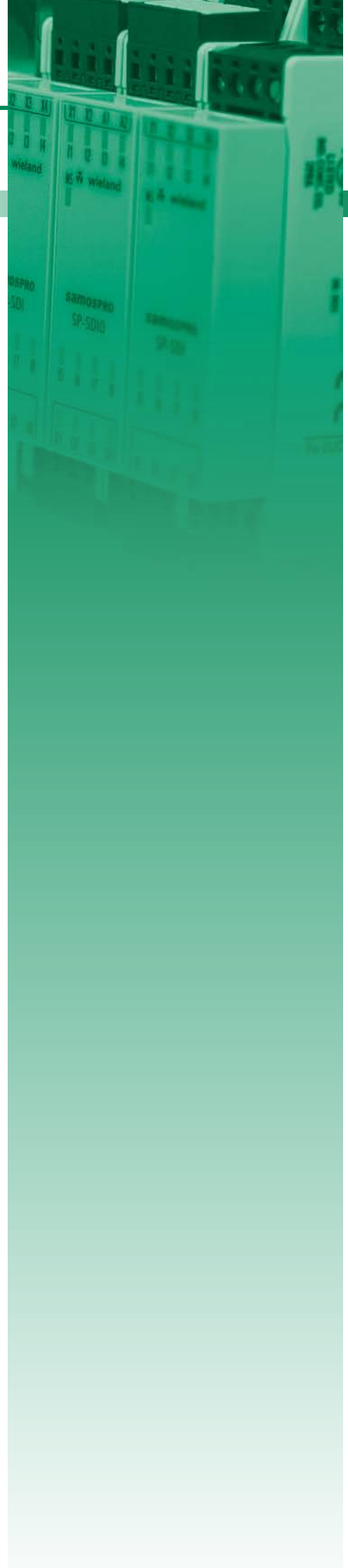

Overview

Order no.	Name/Description	Page
Safety electronic module		
R119000100	samosPRO SP-SCON-P1-K ‣ samosPRO, controller module (without programm memory)	657
R119000200	samosPRO SP-SCON-NET-P1-K ‣ samosPRO, Controller-module (without memory plug) with EFI-Interface for samosNET	657
R119000300	samosPRO SP-SDIO84-P1-K-A ‣ samosPRO, IO-module with 8 input/4 solid state output, screw clamp terminal pluggable	657
R119000400	samosPRO SP-SDIO84-P1-K-C ‣ samosPRO, IO-module with 8 input/4 solid state output, spring clamp terminal pluggable	657
R119000500	samosPRO SP-SDI8-P1-K-A ‣ samosPRO, IN-module with 8 input, screw clamp terminal pluggable	658
R119000600	samosPRO SP-SDI8-P1-K-C ‣ samosPRO, IN-module with 8 input, spring clamp terminal pluggable	658
Gateway module		
R119001300	samosPRO SP-EN-MOD ‣ samosPRO buscoupling modul for Modbus TCP	659
R119001400	samosPRO SP-EN-PN ‣ samosPRO buscoupling modul for PROFINET IO	659
R119001500	samosPRO SP-EN-IP ‣ samosPRO buscoupling modul for EtherNet/IP	659
R119001900	samosPRO SP-PROFIBUS-DP ‣ samosPRO buscoupling modul for Profibus-DP	659
R119002100	samosPRO SP-CANopen ‣ samosPRO gateway for CANopen	660
Safety relay		
R118839300	safeRELAY SNE 4024K-A ‣ Output expansion unit ‣ 2x2 enabling current paths, ‣ 2x1 signalling outputs ‣ DC 24 V ‣ screw-terminals pluggable	661
R118839400	safeRELAY SNE 4024K-C ‣ Output expansion unit ‣ 2x2 enabling current paths ‣ 2x1 signalling outputs ‣ DC 24 V ‣ cage clamp-terminals pluggable	661





Safety electronic module

samosPRO Safety electronic module					
R119000100	R119000500				
R119000200	R119000600				
R119000300					
R119000400					

Order number	R119000100	R119000200	R119000300	R119000400
Figure				
Type	-	-	-	-
General information				
Note	-	-	-	-
Features	▷ samosPRO, controller module (without programm memory)	▷ samosPRO, Controller-module (without memory plug) with EFI-Interface for samosNET	▷ samosPRO, IO-module with 8 input/4 solid state output, screw clamp terminal pluggable	▷ samosPRO, IO-module with 8 input/4 solid state output, spring clamp terminal pluggable
Safety				
Safety requirements	SIL CL 3, PL e, Kat 4	SIL CL 3, PL e, Kat 4	SIL CL 3, PL e, Kat 4	SIL CL 3, PL e, Kat 4
Implementation of the electrical connection	-	-	-	-
Power supply (rated value)	DC 24 V	DC 24 V	DC 24 V	DC 24 V
Power supply (permitted range)	DC 16.8...30 V	DC 16.8...30 V	DC 16.8...30 V	DC 16.8...30 V
Power loss	2.5 W	2.5 W	4.5 W	4.5 W
Control circuit				
Number of inputs	-	-	8	8
Input voltage for signal "1"	-	-	DC 13...30 V	DC 13...30 V
Input voltage for signal "0"	-	-	DC -5...5 V	DC -5...5 V
Input current for signal "1"	-	-	8 mA	8 mA
Input current for signal "0"	-	-	2.1 mA	2.1 mA
Output circuit				
Number of outputs	-	-	4	4
Output current at signal "1", rated value	-	-	2 A	2 A
Type of output	-	-	-	-
Short-circuit protection	-	-	yes, electronic	yes, electronic
Sum-current outputs TU ≤ 45°C	-	-	4 A	4 A
Sum-current outputs TU ≤ 55°C	-	-	3.2 A	3.2 A
Certifications				
UL508 certification	yes	yes	yes	yes
Housing				
Material	PC	PC	PC	PC
Mounting	Profile rail 35 mm	Profile rail 35 mm	Profile rail 35 mm	Profile rail 35 mm
Mechanical data				
Dimensions (WxHxD)	22.5 mm x 96.5 mm x 121 mm	22.5 mm x 96.5 mm x 121 mm	22.5 mm x 96.5 mm x 121 mm	22.5 mm x 96.5 mm x 121 mm
Weight	111 g	119 g	164 g	164 g
Environmental conditions				
Operating temperature	-25 °C to 55 °C	-25 °C to 55 °C	-25 °C to 55 °C	-25 °C to 55 °C
Storage temperature	-25 °C to 70 °C	-25 °C to 70 °C	-25 °C to 70 °C	-25 °C to 70 °C
Certifications				
UL508 certification	yes	yes	yes	yes





Safety electronic module

samosPRO Safety electronic module					
R119000100	R119000500				
R119000200	R119000600				
R119000300					
R119000400					

Order number	R119000500	R119000600		
Figure				
Type	-	-		
General information				
Note	-	-		
Features	▷ samosPRO, IN-module with 8 input, screw clamp terminal pluggable	▷ samosPRO, IN-module with 8 input, spring clamp terminal pluggable		
Safety				
Safety requirements	SIL CL 3, PL e, Kat 4	SIL CL 3, PL e, Kat 4		
Implementation of the electrical connection	-	-		
Power supply (rated value)	DC 24 V	DC 24 V		
Power supply (permitted range)	DC 16.8...30 V	DC 16.8...30 V		
Power loss	4 W	4 W		
Control circuit				
Number of inputs	8	8		
Input voltage for signal "1"	DC 13...30 V	DC 13...30 V		
Input voltage for signal "0"	DC -5...5 V	DC -5...5 V		
Input current for signal "1"	8 mA	8 mA		
Input current for signal "0"	2.1 mA	2.1 mA		
Output circuit				
Number of outputs	-	-		
Output current at signal "1", rated value	-	-		
Type of output	-	-		
Short-circuit protection	-	-		
Sum-current outputs TU <= 45°C	-	-		
Sum-current outputs TU <= 55°C	-	-		
Certifications				
UL508 certification	yes	yes		
Housing				
Material	PC	PC		
Mounting	Profile rail 35 mm	Profile rail 35 mm		
Mechanical data				
Dimensions (WxHxD)	22.5 mm x 96.5 mm x 121 mm	22.5 mm x 96.5 mm x 121 mm		
Weight	139 g	139 g		
Environmental conditions				
Operating temperature	-25 °C to 55 °C	-25 °C to 55 °C		
Storage temperature	-25 °C to 70 °C	-25 °C to 70 °C		
Certifications				
UL508 certification	yes	yes		

Gateway module

samosPRO Gateway module					
R119001300	R119002100				
R119001400					
R119001500					
R119001900					

Order number	R119001300	R119001400	R119001500	R119001900
Figure				
Type	-	-	-	-
General information				
Note	-	-	-	-
Features	▷ samosPRO buscoupling modul for Modbus TCP	▷ samosPRO buscoupling modul for PROFINET IO	▷ samosPRO buscoupling modul for EtherNet/IP	▷ samosPRO buscoupling modul for Profibus-DP
Safety				
Safety requirements	-	-	-	-
Implementation of the electrical connection	-	-	-	-
Power supply (rated value)	DC 24 V	DC 24 V	DC 24 V	DC 24 V
Power supply (permitted range)	DC 16.8...30 V	DC 16.8...30 V	DC 16.8...30 V	DC 16.8...30 V
Power loss	2.4 W	2.4 W	2.4 W	2.4 W
Communication				
Fieldbus	Modbus / TCP/IP	PROFINET-IO	EtherNet/IP	PROFIBUS-DP to EN 50170
Type of interface	Ethernet 10/100 MBit	Ethernet 10/100 MBit	Ethernet 10/100 MBit	RS485 isolated
Topology isolated	✓	✓	✓	✓
Node addresses	IP V4 address	IP V4 address	IP V4 address	1 - 125
Transmission speed, min.	10 Mbit/s	10 Mbit/s	10 Mbit/s	9.6 kbit/s
Transmission speed, max.	100 Mbit/s	100 Mbit/s	100 Mbit/s	12 Mbit/s
Certifications				
UL508 certification	yes	yes	yes	yes
Housing				
Material	PC	PC	PC	PC
Mounting	Profile rail 35 mm	Profile rail 35 mm	Profile rail 35 mm	Profile rail 35 mm
Mechanical data				
Dimensions (WxHxD)	22.5 mm x 96.5 mm x 121 mm	22.5 mm x 96.5 mm x 121 mm	22.5 mm x 96.5 mm x 121 mm	22.5 mm x 96.5 mm x 121 mm
Weight	160 g	160 g	160 g	160 g
Environmental conditions				
Operating temperature	-25 °C to 55 °C	-25 °C to 55 °C	-25 °C to 55 °C	-25 °C to 55 °C
Storage temperature	-25 °C to 70 °C	-25 °C to 70 °C	-25 °C to 70 °C	-25 °C to 70 °C
Certifications				
UL508 certification	yes	yes	yes	yes



Gateway module

samosPRO Gateway module					
R119001300	R119002100				
R119001400					
R119001500					
R119001900					

Order number	R119002100			
Figure				
Type	-			
General information				
Note	-			
Features	▶ samosPRO gateway for CANopen			
Safety				
Safety requirements	-			
Implementation of the electrical connection	-			
Power supply (rated value)	DC 24 V			
Power supply (permitted range)	DC 16.8...30 V			
Power loss	2.4 W			
Communication				
Fieldbus	CANopen			
Type of interface	CAN			
Topology isolated	✓			
Node addresses	1 - 127			
Transmission speed, min.	125 kbit/s			
Transmission speed, max.	1 Mbit/s			
Certifications				
UL508 certification	yes			
Housing				
Material	PC			
Mounting	Profile rail 35 mm			
Mechanical data				
Dimensions (WxHxD)	22.5 mm x 96.5 mm x 121 mm			
Weight	160 g			
Environmental conditions				
Operating temperature	-25 °C to 55 °C			
Storage temperature	-25 °C to 70 °C			
Certifications				
UL508 certification	yes			

Safety relay

samosPRO Safety relay						
R118839300						
R118839400						

Order number	R118839300	R118839400		
Figure				
Type	-	-		
General information				
Note	-	-		
Features	<ul style="list-style-type: none"> ▸ Output expansion unit ▸ 2x2 enabling current paths, ▸ 2x1 signalling outputs ▸ DC 24 V ▸ screw-terminals pluggable 	<ul style="list-style-type: none"> ▸ Output expansion unit ▸ 2x2 enabling current paths ▸ 2x1 signalling outputs ▸ DC 24 V ▸ cage clamp-terminals pluggable 		
Safety				
Safety requirements	SIL CL 3, PL e, Kat 4	SIL CL 3, PL e, Kat 4		
Implementation of the electrical connection	-	-		
Power supply (rated value)	DC 24 V	DC 24 V		
Power supply (permitted range)	-	-		
Power loss	1.4 W	1.4 W		
Output circuit Relais				
Number enabling current path	4	4		
Number signaling current path	2	2		
max. Thermal continuous current: enabling current path	6 A	6 A		
max. Thermal continuous current: signaling current path	2 A	2 A		
Utilization category AC-15	Ue 230 V, Ie 3 A	Ue 230 V, Ie 3 A		
Utilization category DC-13	Ue 24 V, Ie 1 A	Ue 24 V, Ie 1 A		
Number of operating cycle of relay outputs	10 ⁷	10 ⁷		
Max. peak current at control inputs	110 mA	110 mA		
Certifications	-	-		
UL508 certification	yes	yes		
Housing				
Material	PC	PC		
Mounting	Profile rail 35 mm	Profile rail 35 mm		
Mechanical data				
Dimensions (WxHxD)	22.5 mm x 96.5 mm x 114 mm	22.5 mm x 96.5 mm x 114 mm		
Weight	180 g	180 g		
Environmental conditions				
Operating temperature	-25 °C to 65 °C	-25 °C to 65 °C		
Storage temperature	-25 °C to 70 °C	-25 °C to 70 °C		
Certifications				
UL508 certification	yes	yes		

Accessories

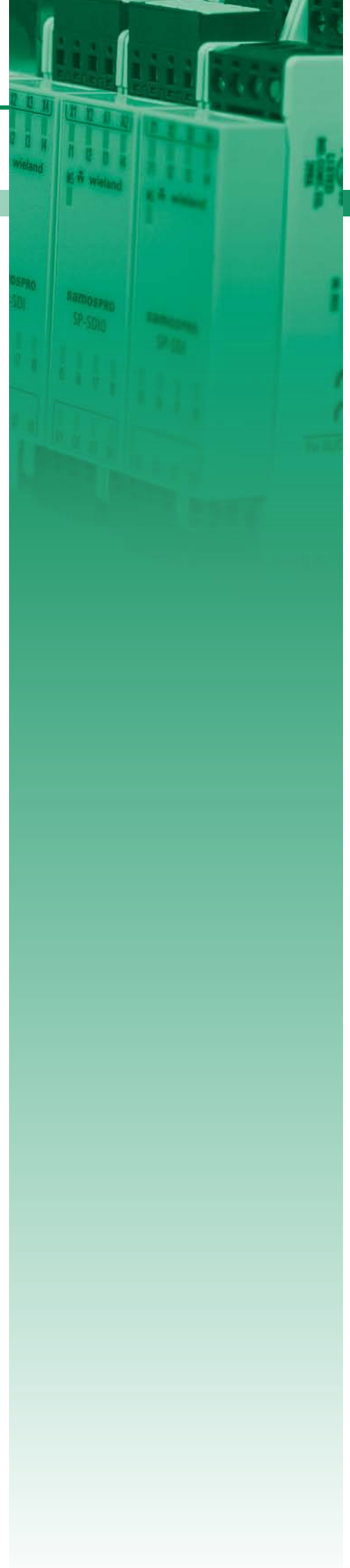

Accessories

Order number	Type	Description	Note
R119000800	samosPRO SP-MEMORY	samosPRO, programm memory, pluggable	
R119000900	samosPRO SP-CABLE1	samosPRO, cable, 2m, M8-DSUB	
R119001000	samosPRO SP-PRO-STARTER-SET	samosPRO, Starter-Set (SP-SCON, SP-SDIO84, SP-PLAN, SP-MEMORY, SP-CABLE1, SP-CONVERTER)	
R119002500	samosPRO SP-CONVERTER	USB-RS232-adapter	
R119002600	samosPRO SP-FILTER1	samosPRO-Output-Filter, 680nF	
R119002700	samosPRO SP-FILTER2	samosPRO SP-FILTER2	



At a glance

Solutions

666



| Solutions

Solutions



VIPA Green Solution

A new approach for energy management

Management systems are modern tools of corporate management that give enterprises a kind of regulation framework for important business areas. There are standards and certifications for the different areas to document the application of management systems within the company and externally. The best known are: the quality management in accordance with ISO 9001, the environment management in accordance with ISO 14001 and the energy management in accordance with DIN EN ISO 50001.

The conscious use of energy in all areas of life is becoming increasingly important. Protecting the environment is only one aspect. In fact with permanently increasing energy costs it's more a matter of finding suitable measures in businesses to uncover and implement potential savings in energy use. This is where the VIPA Green Solution, which can be adapted exactly to the requirements and needs of customers by means of individually selectable modules, takes effect.

With the VIPA Green Solution you receive an easy and reliable energy management system together with control components from a single source. Consultancy and implementing solutions form the scope of our service. With the Green Solution we offer you all tools that are required for the **energy audit and the certification in accordance with DIN EN ISO 50001 or DIN EN 16247-1**. Finally all measures in the framework of energy management lead to decreasing energy costs and a significant improvement of your **energy balance**.

Overview

Order no.	Name/Description
Energiemanagement	
810-0AA20	VIPA EnMS Training <ul style="list-style-type: none"> › Training VIPA EnMS development packet › Professional target oriented technical in-house training, at supply of the development environment one days training must be booked in order to deal with the package can. › Recommendation: 2 days, further days optional (additionally hotel and travel costs according to voucher)
810-1AA20	VIPA EnMS Ingenieur <ul style="list-style-type: none"> › Engineer for integration, programming and commissioning › Installation and cabling is not part of our service
810-2CC31	VIPA EnMS 16 TP CE (8,4") <ul style="list-style-type: none"> › Energy management for 16 test points including VIPA 8,4" professional panel › Logging in MSSQL data base › connection of the measuring instruments via ModbusRTU/ModbusTCP
810-2CD31	VIPA EnMS 32 TP CE (8,4") <ul style="list-style-type: none"> › Energy management for 32 test points including VIPA 8,4" professional panel › Logging in MSSQL data base › connection of the measuring instruments via ModbusRTU/ModbusTCP
810-2CE31	VIPA EnMS 48 TP CE (8,4") <ul style="list-style-type: none"> › Energy management for 48 test points including VIPA 8,4" professional panel › Logging in MSSQL data base › connection of the measuring instruments via ModbusRTU/ModbusTCP
810-2DC31	VIPA EnMS 16 TP CE (10,4") <ul style="list-style-type: none"> › Energy management for 16 test points including VIPA 10,4" professional panel › Logging in MSSQL data base › connection of the measuring instruments via ModbusRTU/ModbusTCP
810-2DD31	VIPA EnMS 32 TP CE (10,4") <ul style="list-style-type: none"> › Energy management for 32 test points including VIPA 10,4" professional panel › Logging in MSSQL data base › connection of the measuring instruments via ModbusRTU/ModbusTCP
810-2DE31	VIPA EnMS 48 TP CE (10,4") <ul style="list-style-type: none"> › Energy management for 48 test points including VIPA 10,4" professional panel › Logging in MSSQL data base › connection of the measuring instruments via ModbusRTU/ModbusTCP
810-2EC31	VIPA EnMS 16 TP CE (12,1") <ul style="list-style-type: none"> › Energy management for 16 test points including VIPA 12,1" professional panel › Logging in MSSQL data base › connection of the measuring instruments via ModbusRTU/ModbusTCP
810-2ED31	VIPA EnMS 32 TP CE (12,1") <ul style="list-style-type: none"> › Energy management for 32 test points including VIPA 12,1" professional panel › Logging in MSSQL data base › connection of the measuring instruments via ModbusRTU/ModbusTCP
810-2EE31	VIPA EnMS 48 TP CE (12,1") <ul style="list-style-type: none"> › Energy management for 48 test points including VIPA 12,1" professional panel › Logging in MSSQL data base › connection of the measuring instruments via ModbusRTU/ModbusTCP
810-3AA61	VIPA EnMS evaluation including IPC <ul style="list-style-type: none"> › VIPA EnMS evaluation according to cost center development packet including IPC › Development software packet for step by step setup of an own energy management system, with functions and structures for classification of counter values to cost centers. › Basis are count values written from VIPA EnMS system in SQL databases. › No turn-key system, but expandable with easy expand- and addable functions › IPC for mounting on wall or in the control cubicle, without fan, 24VDC board connection, Windows 7 Professional, 32Bit DE, installed, incl. service pack 1, but without monitor, keyboard and mouse › You are able to expand the system to your demands with the VIPA training. Develop- and runtime version with 16000 tags › Including web license for 8 WebThin client, single license for 1 PC, installation on VIPA EnMS IPC

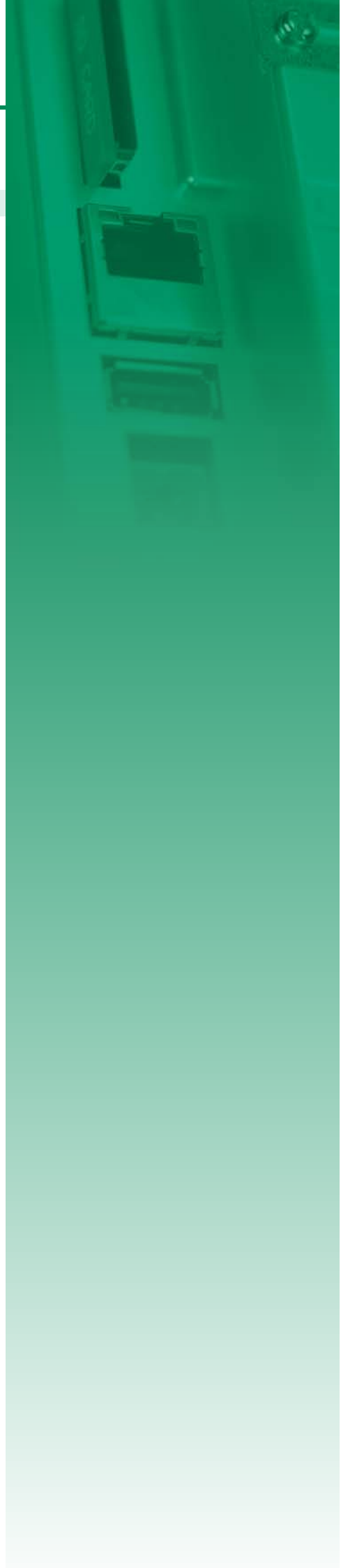

- SLIO
- 100V
- 200V
- 300S
- 500S
- HMI
- Teleservice
- StarterKits
- Safety
- Solutions
- Software
- Accessories
- Appendix

Overview

Order no.	Name/Description
810-3AE61	Energy management for 48 test points including IPC <ul style="list-style-type: none"> › for mounting on wall or in the control cubicle, without fan, 24VDC board connection, Windows 7 Professional, 32Bit DE, installed › installed, incl. service pack 1, but without monitor, keyboard and mouse › connection of the measuring instrument via ModbusTCP › Logging in MSSQL data base, MS-SQL-Express is preinstalled on this system
810-3AG61	Energy management for 128 test points including IPC <ul style="list-style-type: none"> › for mounting on the wall or in the control cubicle, without fan, 24VDC board connection, Windows 7 Professional, 32Bit DE, installed › incl. service pack 1, but without monitor, keyboard and mouse › connection of the measuring instrument via ModbusTCP › Logging in MSSQL data base, MS-SQL-Express is preinstalled on this system
810-3AH61	Energy management for 256 test points including IPC <ul style="list-style-type: none"> › for mounting on the wall or in the control cubicle, without fan, 24VDC board connection, Windows 7 Professional, 32Bit DE, installed › incl. service pack 1, but without monitor, keyboard and mouse › connection of the measuring instrument via ModbusTCP › Logging in MSSQL data base, MS-SQL-Express is preinstalled on this system
810-5AA21	VIPA EnMS evaluation without IPC <ul style="list-style-type: none"> › VIPA EnMS evaluation according to cost center development packet › Development software packet for step by step setup of an own energy management system, with functions and structures for classification of counter values to cost centers. Basis are count values written from VIPA EnMS system in SQL databases. › No turn-key system, but expandable with easy expand- and addable functions You are able to expand the system to your demands with the VIPA training. Develop and runtime version with 16000 tags. › Including web license for 8 WebThin client, single license for 1 PC, installation on VIPA EnMS IPC › Deliverable only in combination with a VIPA EnMS IPC system, a later installation is not possible!

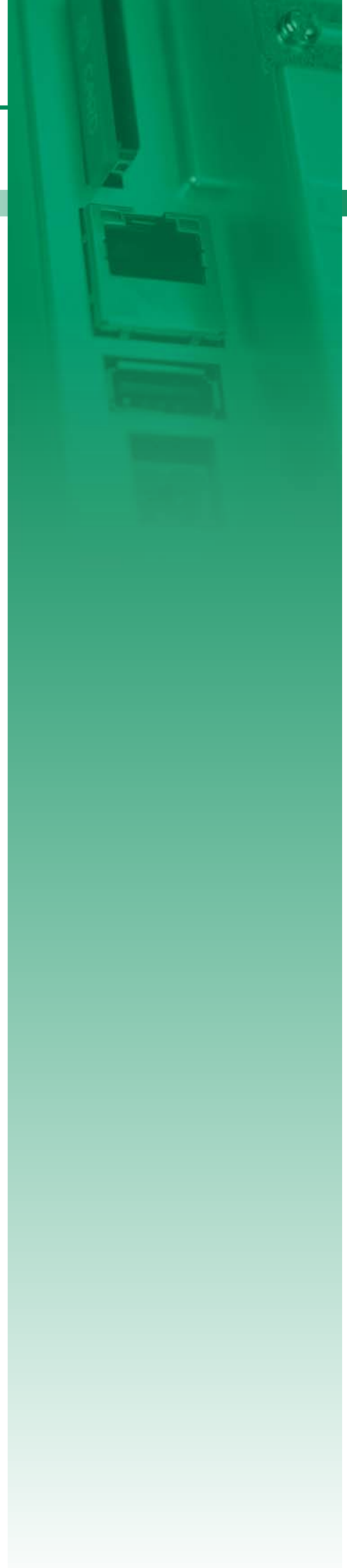

At a glance

Software

672



| Software

Software



Structure and Function

Software tools allow a comfortable programming and parameterization of VIPA systems and other automation concepts. These software tools are included on the tool demo CD (SW900TOLA) as activatable full versions.

OPC-Server

The OPC-Server provides the standard interface for accessing data from OPC clients to PLC systems from different manufacturers. The OPC-Server supports TCP/IP networks via standard network cards as well as MPI networks that have one or more COM ports, an MPI-serial converter and/or are connected via VIPA MPI-USB adapter.

Programming Software

WinPLC7 is a programming system for Systems 100V up to 500S as well as for the Siemens controllers S7-300 and S7-400.

Parameterization Software

Different parameterization tools are available to users:

TD-Wizard: Parameterization tool for VIPA TD 03

WinNCS: PROFIBUS-DP and Ethernet- parameterization/configuration by VIPA controllers and communication processors

WinCoCT: Configuration of CANopen networks with VIPA System

OP-Manager: Parameterization tool for VIPA OP 03 and CC 03

Other Software and Tools:





- › WinPLC Analyzer for PLC user programs
- › WinLP - Labeling software for VIPA System 200V
- › EPLAN macros - technical information and drawings to the VIPA systems 100V, 200V, 300S and HMI
- › Handling blocks - Libraries for VIPA systems and components
- › Demo projects - configurations for VIPA System 200V and 300S
- › GSD/EDS files - configuration files for PROFIBUS-DP and CANopen
- › How-to-do - initial operation information

Manuals
Datasheets
Catalogues
Presentations
Flyer





Communication software

Software Communication software						
SW110A1LA	SW15AS22A					
SW110A2LA	SW15AS23A					
SW110A3LA						
SW15AS21A						

Order number	SW110A1LA	SW110A2LA	SW110A3LA	SW15AS21A
Figure				
Type	OPC-Server	OPC-Server	OPC-Server	-
General information				
Note	-	-	-	-
Features	<ul style="list-style-type: none"> ▸ For serial MPI communication (PC: COM Port PLC: MPI Port) ▸ Single license part of the Tool Demo-CD SW900TOLA 	<ul style="list-style-type: none"> ▸ For PG/OP / TCP/IP communication (PC: Ethernet Port PLC: Ethernet Port) ▸ For all VIPA CPUs with integrated PG/OP interface ▸ Single license part of the Tool Demo-CD SW900TOLA 	<ul style="list-style-type: none"> ▸ For CP communication with configured connections (PC: Ethernet Port PLC: Ethernet Port) ▸ Required: CP343, CPU315SN/NET, 317SN/NET ▸ Single license part of the Tool Demo-CD SW900TOLA 	<ul style="list-style-type: none"> ▸ S7 communication driver (Windows-32-Bit-DLL) for all common high level languages ((C++, C#, VB, VB.NET, DELPHI). ▸ For VIPA SPEED7 CPUs and Siemens S7 CPUs.
Software attributes				
Premise (minimum)	-	-	-	-
Premise (recommended)	-	-	-	-
Target platform	Windows XP (SP3), Vista, 7 (32Bit/64Bit), Server 2003 (SP2), 2008, 2008R2	Windows XP (SP3), Vista, 7 (32Bit/64Bit), Server 2003 (SP2), 2008, 2008R2	Windows XP (SP3), Vista, 7 (32Bit/64Bit), Server 2003 (SP2), 2008, 2008R2	Windows XP (SP3), Vista, 7 (32Bit/64Bit), 8 (32Bit/64Bit)
License model	single user license	single user license	single user license	developer license





Communication software

Software Communication software						
SW110A1LA	SW15AS22A					
SW110A2LA	SW15AS23A					
SW110A3LA						
SW15AS21A						

Order number	SW15AS22A	SW15AS23A		
Figure				
Type	-	-		
General information				
Note	-	-		
Features	<ul style="list-style-type: none"> ▸ S7 communication driver expansion for 64Bit application (Windows-64-Bit-DLL) for high level language C++. ▸ For VIPA SPEED CPUs and Siemens S7 CPUs. 	<ul style="list-style-type: none"> ▸ S7 communication driver for Windows Embedded CE 6.0 (ARM) and C++. ▸ For VIPA SPEED7 CPUs and Siemens S7 CPUs. 		
Software attributes				
Premise (minimum)	-	-		
Premise (recommended)	-	-		
Target platform	Windows 7 (64Bit), 8 (64Bit)	-		
License model	developer license	developer license		



Programming software

Software Programming software						
SW211C1DD	SW211K1OD					
SW211C1ED	SW211K2OD					
SW211D1DD						
SW211D1ED						

Order number	SW211C1DD	SW211C1ED	SW211D1DD	SW211D1ED
Figure				
Type	WinPLC7	WinPLC7	WinPLC7	WinPLC7
General information				
Note	-	-	-	-
Features	<ul style="list-style-type: none"> ▸ Programming-, test-, diagnosis- and simulation software for VIPA Systems and S7-300 from Siemens, STL-, LAD- and FBD programming 	<ul style="list-style-type: none"> ▸ Programming-, test-, diagnosis- and simulation software for VIPA Systems and S7-300 from Siemens, STL-, LAD- and FBD programming 	<ul style="list-style-type: none"> ▸ Programming-, test-, diagnosis- and simulation software for VIPA Systems and S7-300 from Siemens, STL-, LAD- and FBD programming, Download version: http://www.winplc7.com/v5/vipa-download.htm 	<ul style="list-style-type: none"> ▸ Programming-, test-, diagnosis- and simulation software for VIPA Systems and S7-300 from Siemens, STL-, LAD- and FBD programming, Download version: http://www.winplc7.com/v5/vipa-download.htm
Software attributes				
Premise (minimum)	-	-	-	-
Premise (recommended)	-	-	-	-
Target platform	Windows XP (SP3), 7 (32Bit/64Bit), 8 (32Bit/64Bit)	Windows XP (SP3), 7 (32Bit/64Bit), 8 (32Bit/64Bit)	Windows XP (SP3), 7 (32Bit/64Bit), 8 (32Bit/64Bit)	Windows XP (SP3), 7 (32Bit/64Bit), 8 (32Bit/64Bit)
License model	single user license	single user license	single user license	single user license





Programming software

Software Programming software						
SW211C1DD	SW211K1OD					
SW211C1ED	SW211K2OD					
SW211D1DD						
SW211D1ED						

Order number	SW211K1OD	SW211K2OD		
Figure				
Type	WinPLC7	WinPLC7lite		
General information				
Note	-	-		
Features	<ul style="list-style-type: none"> ▸ Programming-, test-, diagnosis- and simulation software for VIPA Systems and S7-300 from Siemens, STL-, LAD- and FBD programming, Download-Version: http://www.winplc7.com/v5/vipa-download.htm 	<ul style="list-style-type: none"> ▸ Licensable with System 100V CPUs, included on SW900T0LA ToolDemo CD, registration via Internet possible 		
Software attributes				
Premise (minimum)	-	-		
Premise (recommended)	-	-		
Target platform	Windows XP (SP3), 7 (32Bit/64Bit), 8 (32Bit/64Bit)	Windows XP (SP3), 7 (32Bit/64Bit), 8 (32Bit/64Bit)		
License model	single user license	single user license		



Parameterization software

Software Parameterization software						
SW30001LA						
SW300T1EA						
SW300C1EA						
SW300P1LA						

Order number	SW30001LA	SW300T1EA	SW300C1EA	SW300P1LA
Figure				
Type	OP-Manager	TD-Wizard	WinCoCT	WinNCS
General information				
Note	-	-	-	-
Features	<ul style="list-style-type: none"> › Single licence, parameterization tool for OP 03 	<ul style="list-style-type: none"> › Parameterization tool for TD 03 (included on Tool Demo CD SW900T0LA) 	<ul style="list-style-type: none"> › CANopen configuration tool 	<ul style="list-style-type: none"> › Universal parameterization and configuration tool, components engineering, Ethernet protocols, TCP/IP, SINEC H1, IPK, RFC1006 - PROFIBUS-DP (2BF), included on Tool Demo CD SW900T0LA
Software attributes				
Premise (minimum)	-	-	-	-
Premise (recommended)	-	-	-	-
Target platform	-	-	-	-
License model	single user license	single user license	-	single user license

Analysis tool

Software Analysis tool						
SW711A1LA						
SW711A2LA						
SW900T0LA						

Order number	SW711A1LA	SW711A2LA	SW900T0LA	
Figure				
Type	WinPLC-Analyzer	WinPLC-Analyzer	ToolDemo-CD	
General information				
Note	-	-	-	
Features	<ul style="list-style-type: none"> CD + dongle, German/English, for VIPA Systems and S7-300/400 from Siemens (in combination with WinPLC7), incl. driver 	<ul style="list-style-type: none"> CD + dongle, German/English, for VIPA Systems and S7-300/400 from Siemens, incl. driver 	<ul style="list-style-type: none"> Demo versions/ registration possible, WinPLC7, Movicon11 Editor, OP manager, TD wizard, OPC server, WinCoCT, WinNCS, GSD-/EDS files, handling blocks, drivers, How-to-do's 	
Software attributes				
Premise (minimum)	-	-	-	
Premise (recommended)	-	-	-	
Target platform	Windows XP (SP3), 7 (32Bit/64Bit), 8 (32Bit/64Bit)	Windows XP (SP3), 7 (32Bit/64Bit), 8 (32Bit/64Bit)	-	
License model	single user license	single user license	-	

At a glance

S5 components	683
FIELDBUS accessories	685
Miscellaneous	685
Cables	686
Antennas and accessories	686
Manuals and operating instructions	687

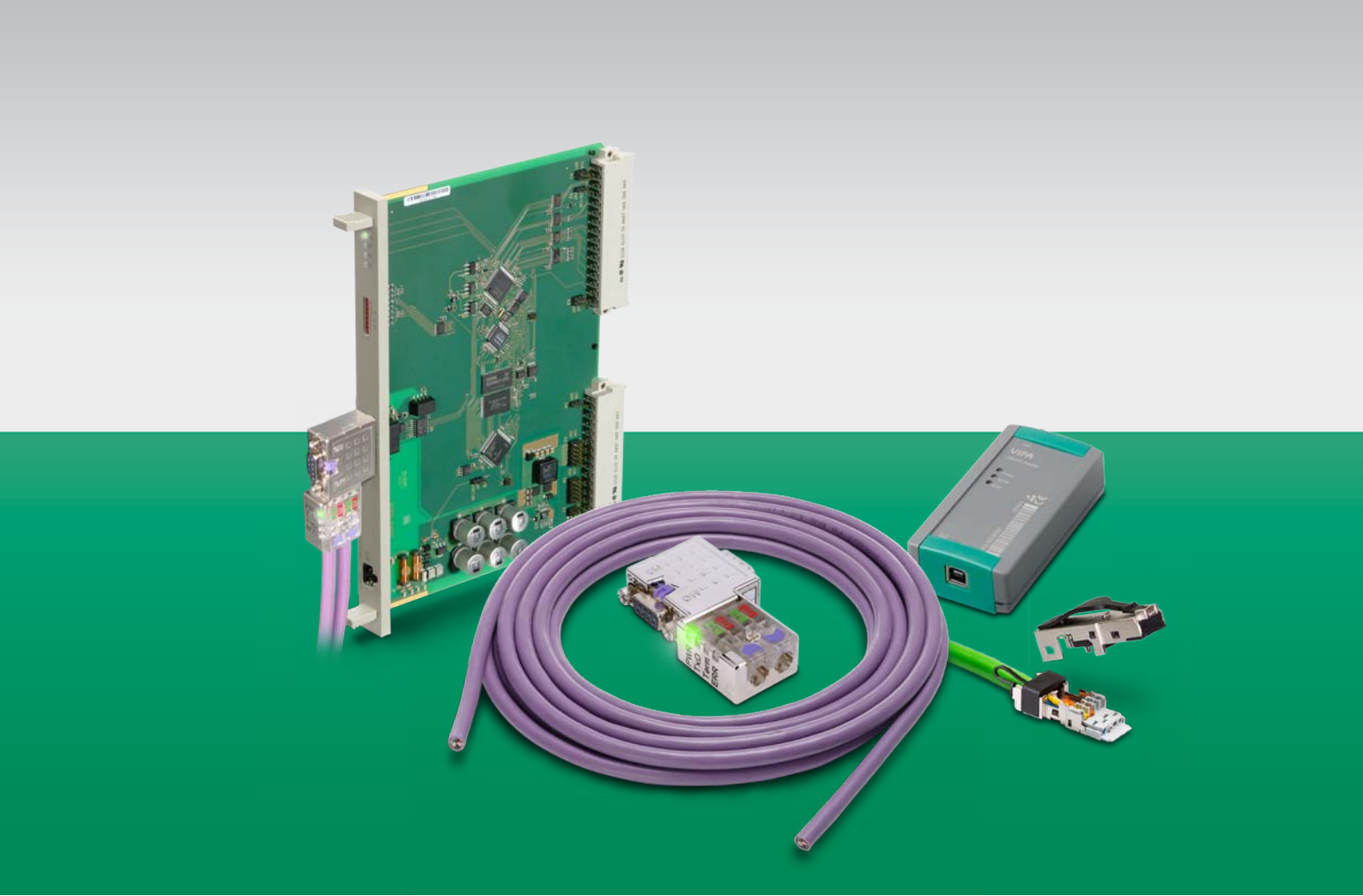

| Accessories

Accessories



Structure and Function

The accessories expand the functionality and the application range of the control of VIPA systems of other manufacturers. The accessories are useable across systems and are largely manufacturer independent.

Interface modules

The IM 306 modules, or PROFIBUS-DP slave interface cards for the SIMATIC S5, enable simple, economical and safe upgrading to newer control systems with PROFIBUS-DP master interfaces, while maintaining the Siemens SIMATIC S5 peripherals.

Cables and DP connectors



Accessories, such as programming and PROFIBUS cables in various lengths, PROFIBUS-DP connectors with integrated intelligence and LED diagnostic display, a comprehensive set of adapters, rails, and connectors support the versatile use of the systems.

The bus connector EasyConn PB is used for connection of PROFIBUS participants in the bus line. The diagnostic LEDs, visible from all sides, facilitate starting considerably. The status of bus activity, the final resistance, the power supply and bus status are directly visible. The integrated controller supports data rates up to 12 Mbit/s.



S5 components



Order number	306-1LE00	306-1UE00	306-1UZ00	
Figure				
Type	IM 306 DP slave 115U	IM 306 DP slave 135U/155U	IM 306 DP slave 135U/155U	
General information				
Note	-	-	-	
Features	<ul style="list-style-type: none"> ‣ Converting Siemens S5 PLCs to S7 ‣ Exclusively suited for AG-115U central controller and expansion units ‣ Integrated DC 24V power supply 	<ul style="list-style-type: none"> ‣ Converting Siemens S5 PLCs to S7 ‣ Exclusively suited for AG-135U/155U central controller and expansion units ‣ Integrated DC 24V power supply 	<ul style="list-style-type: none"> ‣ Converting Siemens S5 systems to S7 ‣ Exclusively suited for AG-135U/155U central controller 	
Technical data power supply				
Power supply (rated value)	DC 24 V	DC 24 V	DC 5 V	
Power supply (permitted range)	DC 20.4...28.8 V	DC 20.4...28.8 V	-	
Reverse polarity protection	✓	✓	-	
Current consumption (no-load operation)	0.1 A	0.1 A	0.4 A	
Current consumption (rated value)	1 A	1 A	0.4 A	
Inrush current	4 A	4 A	-	
I^2t	0.5 A ² s	0.5 A ² s	-	
Max. current drain at backplane bus	3.5 A	3.5 A	-	
Max. current drain load supply	-	-	-	
Power loss	4 W	4 W	2 W	
Status information, alarms, diagnostics				
Status display	yes	yes	yes	
Interrupts	yes, parameterizable	yes, parameterizable	yes, parameterizable	
Process alarm	no	no	yes, parameterizable	
Diagnostic interrupt	yes, parameterizable	yes, parameterizable	yes, parameterizable	
Diagnostic functions	yes, parameterizable	yes, parameterizable	yes, parameterizable	
Diagnostics information read-out	possible	possible	possible	
Supply voltage display	green LED	green LED	green LED	
Service Indicator	-	-	-	
Group error display	red LED	red LED	red LED	
Channel error display	none	none	none	

Order number	306-1LE00	306-1UE00	306-1UZ00	
Hardware configuration				
Racks, max.	1	1	1	
Modules per rack, max.	9	18	18	
Number of digital modules, max.	9	18	18	
Number of analog modules, max.	9	18	18	
Communication				
Fieldbus	PROFIBUS-DP to EN 50170	PROFIBUS-DP to EN 50170	PROFIBUS-DP to EN 50170	
Type of interface	RS485 isolated	RS485 isolated	RS485 isolated	
Connector	Sub-D, 9-pin, female	Sub-D, 9-pin, female	Sub-D, 9-pin, female	
Topology	Linear bus with bus termination at both ends	Linear bus with bus termination at both ends	Linear bus with bus termination at both ends	
Electrically isolated	✓	✓	✓	
Number of participants, max.	125	125	125	
Node addresses	1 - 125	1 - 125	1 - 125	
Transmission speed, min.	9.6 kbit/s	9.6 kbit/s	9.6 kbit/s	
Transmission speed, max.	12 Mbit/s	12 Mbit/s	12 Mbit/s	
Address range inputs, max.	244 Byte	244 Byte	244 Byte	
Address range outputs, max.	244 Byte	244 Byte	244 Byte	
Number of TxPDOs, max.	-	-	-	
Number of RxPDOs, max.	-	-	-	
Housing				
Material	PC GF20	PC GF20	PC GF20	
Mounting	-	-	-	
Mechanical data				
Dimensions (WxHxD)	20 mm x 233.4 mm x 160 mm	20 mm x 233.4 mm x 160 mm	20 mm x 233.4 mm x 160 mm	
Weight	220 g	220 g	190 g	
Environmental conditions				
Operating temperature	0 °C to 60 °C	0 °C to 60 °C	0 °C to 60 °C	
Storage temperature	-25 °C to 70 °C	-25 °C to 70 °C	-25 °C to 70 °C	
Certifications				
UL508 certification	-	-	-	

FIELDBUS accessories



Order number	Type	Description	Note
972-0DP01	EasyConn 90° - PROFIBUS plug	12 Mbit/s, metal case, PG-jack, insulation piercing connection, switchable termination resistor, 90° outgoing cable	
972-9DP01	EasyConn 90° - PROFIBUS plug	12 Mbit/s, metal case, PG-jack, insulation piercing connection, switchable termination resistor, 90° outgoing cable, ECO pack: 100 pieces	
972-0DP10	EasyConn 90° - PROFIBUS plug	12 Mbit/s, metal case, PG-jack, insulation piercing connection, switchable termination resistor, 90° outgoing cable, bus diagnosis via LEDs	
972-9DP10	EasyConn 90° - PROFIBUS plug	12 Mbit/s, metal case, PG-jack, insulation piercing connection, switchable termination resistor, 90° outgoing cable, bus diagnosis via LEDs, ECO pack: 100 pieces	
972-0DP20	EasyConn 45° - PROFIBUS plug	12 Mbit/s, metal case, PG-jack, insulation piercing connection, switchable termination resistor, 45° outgoing cable, bus diagnosis via LEDs	
972-9DP20	EasyConn 45° - PROFIBUS plug	12 Mbit/s, metal case, PG-jack, insulation piercing connection, switchable termination resistor, 45° outgoing cable, bus diagnosis via LEDs, ECO pack: 100 pieces	
972-0DP30	EasyConn 0° - PROFIBUS plug	12 Mbit/s, metal case, PG-jack, insulation piercing connection, switchable termination resistor, 0° outgoing cable, bus diagnosis via LEDs	
972-9DP30	EasyConn 0° - PROFIBUS plug	12 Mbit/s, metal case, PG-jack, insulation piercing connection, switchable termination resistor, 0° outgoing cable, bus diagnosis via LEDs, ECO pack: 100 pieces	
972-0PN00	PN/EC-Stecker 180° Field Plug	Plug: RJ45, Connection: 8 wire, Connection technique: IDC (insulation displacement connection) terminals, Connection area: AWG24/1 - 22/1 and AWG26/7 - 22/7, Cable diameter: 5,5 - 8,5 mm, Allocation: T568A, T568B, Industrial (4/8 wire)	
972-8PN00	PN/EC-Stecker 180° Field Plug	Plug: RJ45, Connection: 8 wire, Connection technique: IDC (insulation displacement connection) terminals, Connection area: AWG24/1 - 22/1 and AWG26/7 - 22/7, Cable diameter: 5,5 - 8,5 mm, Packaging unit: 10 pieces	
973-1BA00	PROFIBUS-DP/MPI-Repeater	insulated channel (2 segments), up to 31 devices per segment connectable up to 1200 m cable length transparent for all PROFIBUS and MPI protocols	
973-5BE00	PROFIBUS-DP/MPI-Repeater	5 dc-insulated channels (repeater segments) up to 31 devices per segment connectable, 1200m tap line length, Transparent for all PROFIBUS and MPI protocols	

Miscellaneous

Order number	Type	Description	Note
905-6AA00	EasyStrip	Stripping tool for PROFIBUS cable	
6ES5491-0LB11	Adaptation capsule for S5-115U/F	Siemens 6ES5 491-0LB11, Siemens SIMATIC S5, adaptation capsule for S5-115U/F (type ES 902) for connecting of up to 2 modules of S5-135U/155U, refreshed, 1 year warranty	

Cables



Order number	Type	Description	Note
830-0LC00	FCC 2xAWG 22 - Standard PROFIBUS cable	Fixed installation according to EN 50170, flame-retardant according to VDE 0472, T804 test type B, cable shell color violet, 100 m ring	
830-0LD00	FCC 2xAWG 22 - Standard PROFIBUS cable	Fixed installation according to EN 50170, flame-retardant according to VDE 0472, T804 test type B, cable shell color violet, 200 m ring	
830-0LE00	FCC 2xAWG 22 - Standard PROFIBUS cable	Fixed installation according to EN 50170, flame-retardant according to VDE 0472, T804 test type B, cable shell color violet, 500 m ring	
830-0LF00	FCC 2xAWG 22 - Standard PROFIBUS cable	Fixed installation according to EN 50170, flame-retardant according to VDE 0472, T804 test type B, cable shell color violet, 1000 m ring	
830-0PC00	PROFINET cable	100m cable reel	
830-0PD00	PROFINET cable	200m cable reel	
830-0PE00	PROFINET cable	500m cable reel	
830-0PF00	PROFINET cable	1000m cable reel	
950-0AD00	USB adapter	For MMC programming (Windows 98SE/ME/2000/XP)	
950-0AD10	PCMCIA adapter	For MMC programming	
950-0KB00	VIPA "Green Cable"	Programming and download cable, RS232/MP ² , 2 m for VIPA CPUs 100V, 200V and 300V	
950-0KB01	PC/AG programming cable	RS232-MPI/PROFIBUS adapter, 3 m	
950-0KB10	PC/AG programming cable	RS232-MPI/PPI adapter, LCD, 3 m	
950-0KB30	PC/AG programming cable	USB-MPI/PPI adapter, LCD 3 m	
950-0KB31	PC/AG programming cable	USB-MPI/PROFIBUS adapter, 3 m	
950-0KB40	PC/AG programming cable	TCP/IP-MPI/PROFIBUS adapter, 3 m	
950-0KB50	PC/AG programming cable	MPI cable with PU-/Diagnostic port, 2.5 m; use as PC/AG or TP/AG	

Antennas and accessories



Order number	Type	Description	Note
900-0AB50	TM antenna GSM/UMTS	Portable antenna incl. 5m cable, SMA (male) and assembly bracket, resistance: 50 Ohm, power: 10 W, gain: 2.14 dBi, 900/1800 MHz	
900-0AQ51	TM antenna GSM/GPRS	Rod antenna incl. 5m cable and SMA (male) and mounting bracket, resistance: 50 Ohm, power: 20 W, gain: 2.14 dBi, 900/1800 MHz	

Manuals and operating instructions



Order number	Title	Contents	Language
HB37D_IM	Manual Accessories - IM	IM 306 DP slave	DE
HB37E_IM	Manual Accessories - IM	IM 306 DP slave	EN
HB39D_TM	Manual Accessories - TM	TM-E 900-2E6x and TM-H 900-2H6x Teleservice modules	DE
HB39E_TM	Manual Accessories - TM	TM-E 900-2E6x and TM-H 900-2H6x Teleservice modules	EN
HB45D	Manual OPC server - German	Installations and operating manual OPC server	DE
HB45E	Manual OPC server - English	Installations and operating manual OPC server	EN
HB91D	Manual WinNCS - German	Installations and operating manual WinNCS	DE
HB91E	Manual WinNCS - English	Installations and operating manual WinNCS	EN
S7-CRASHKURS-EX	STEP@7-Crashkurs Extended Edition - German/English	Practical introduction into PLC programming with simulation software WinPLC. Targeted at users looking for introduction into PLC programming software STEP@7 and practical experience at the same time.	DE/EN
SW900HOLA	DVD: Manuals & More	Complete documentation on DVD	DE/EN

At a glance

Distributors and branch offices	690
Terms and conditions of sale and delivery	692
General terms and conditions	694



| Appendix

Distributors and branch offices

EUROPE

Austria
 VIPA Elektronik-Systeme GmbH
 Hietzinger Kai 85 / 1.OG
 A-1130 Wien
 Ph.: +43-1-8959363-0
 Fax: +43-1-8959363-50
 Email:elektroniksysteme@vipa.at
 http://www.vipa.at

Belarus
 Vector of Technologies
 Floor 3
 Shafarnyanskaya St. 18
 BY 220125 Minsk
 Ph.: +375-17-265-6015
 Fax: +375-17-265-6016
 Email: info@vec-tech.by
 http://www.vec-tech.by

Belgium
 Bintz Technics N.V.
 Brixtonlaan 23
 BE-1930 Zaventem
 Ph.: +32-2-720-4916
 Fax: +32-2-720-3750
 Email:info@bintz.be
 http://www.bintz.be

Bosnia-Herzegovina
 Please contact
 VIPA Elektronik-Systeme GmbH,
 Austria

Bulgaria
 Atics Ltd.
 Entrance A, floor 1
 No.8, Prof.Dr. Dimitar Dobrev Str.
 BG-1700 Sofia, Studentski grad
 Ph.: +359-2-4653340
 Fax: +359-2-4654479
 Email:office@atics-bg.com
 http://www.atics-bg.com

Croatia
 Please contact
 VIPA Elektronik-Systeme GmbH,
 Austria

Czech Republic
 REM-Technik s.r.o.
 Kliny 35
 CZ-61500 Brno
 Ph.: +420-548-140-000
 Fax: +420-548-140-005
 Email:office@rem-technik.cz
 http://www.rem-technik.cz

Denmark
 VIPA Nordic
 Rönrviksgatan 13
 SE-21374 Malmö
 Sweden
Sales:
 Ph.: +46-8-55-76-16-44
 Email:order@vipanordic.com
Support :
 Ph.: +45-87-50-98-06
 Email: support@vipanordic.com
 http://www.vipanordic.com

Estonia
 Standel AS
 Kiisa 8
 EE-11313 Tallinn
 Ph.: +372-6-558-180
 Fax: +372-6-558-179
 Email:standel@standel.ee
 http://www.standel.ee

Finland
 Sensor Control Nordic AB
 Teknobulevardi 3-5
 FI - 01530 Vantaa
 Ph.: +358-40-1693291
 Email:info@sennordic.fi
 http://www.sennordic.fi

France
 VIPA FRANCE SAS
 78 rue Haxo
 F-75020 Paris
 Ph.: +33-1-43615225
 Fax: +33-1-43615345
 Email: info@vipa.fr
 http://www.vipa.fr

Germany
 VIPA GmbH - Headquarters
 Ohmstr. 4
 D-91074 Herzogenaurach
 Ph.: +49-9132-744-0
 Fax: +49-9132-744-1864
 Email:info@vipa.de
 http://www.vipa.com
 http://www.speed7.com

Great Britain
 VIPA Limited
 6 Kempston Court,
 Manor Road,
 Kempston Hardwick
 Bedford
 MK43 9PQ
 United Kingdom
 Ph.: +44-1234-924324
 Fax: +44-1234-924325
 Email:info@vipa.co.uk
 http://www.vipa.co.uk

Greece
 Technoproodos Ltd.
 Constantinoupoleos 488
 13677 Acharnes
 GR-Athens
 Ph.: +30-210-2406636
 Fax: +30-210-2466288
 Email:info@technoproodos.gr
 http://www.technoproodos.gr

Hungary
 Please contact
 VIPA Elektronik-Systeme GmbH,
 Austria

Ireland
 Please contact
 VIPA Limited, Great Britain

Italy
 VIPA Italia S.r.l.
 Via Lorenzo Bernini 4
 I-25010 San Zeno Naviglio BS
 Ph.: +39-030-2106-959
 Fax: +39-030-2106-742
 Email:info@vipaitalia.it
 http://www.vipaitalia.it

Latvia
 EMT SIA
 Jelgavas iela 44/46
 LV-1004 Riga
 Ph.: +37-17-60-20-27
 Fax: +37-17-60-20-28
 Email:dzintars@emt.lv

Lithuania
 UAB „Elinta“
 Terminalo 3
 Biruliskiu k.
 Karmelavos sen.
 LT-54469 Kauno raj.
 Ph.: +370-37-351999
 Fax: +370-37-452780
 Email:info@elinta.lt
 http://www.elintosprekyba.lt/

Luxemburg
 Please contact
 Bintz technics N.V., Belgium

Macedonia
 Please contact
 VIPA Elektronik-Systeme GmbH,
 Austria

Moldova
 „ElectroTehnolport“ SRL
 61 Hincesti Street
 MD 2028 Chisinau
 Ph.: +373-22-72-15-47
 Fax: +373-22-72-15-47
 Email:elimport@mcc.md
 http://www.electroimport.md

Netherlands
 VIPA Nederland B.V.
 Postbus 824
 NL- 7301 BB Apeldoorn
 Ph.: +31-55-3564208
 Fax: +31-55-3564209
 Email:info@vipa.nl
 http://www.vipa.nl

Norway
 AD Elektronikk AS
 Rasmus Solbergs vei 1
 P.O. box 641
 NO-1401 Ski
 Ph.: +47-6497-6060
 Fax: +47-6497-6070
 Email: salg@ade.no
 http://www.ade.no

Poland
 SDS-AUTOMATYKA
 Poplawski Spolka Jawna
 Ul. Ostrowskiego 30
 PL-53238 Wroclaw
 Ph.: +48-71-339-0441
 Fax: +48-71-339-0488
 Email:biuro@sds-automatyka.pl
 http://www.sds-automatyka.pl
 Region: West

Portugal
 Prosistav LDA
 Zona Industrial da Mota,
 Rua 7 Lote 6a
 Gafanha da Encarnacao
 PT-3830-527 lhavo
 Ph.: +351-234-397-210
 Fax: +351-234-397-219
 Email:prosistav@prosistav.pt

Portugol
 Prosistav LDA
 Zona Industrial da Mota,
 Rua 7 Lote 6a
 Gafanha da Encarnacao
 PT-3830-527 lhavo
 Ph.: +351-234-397-210
 Fax: +351-234-397-219
 Email:prosistav@prosistav.pt

Romania
 Assembla Engineering SRL
 Bld Saturn, nr. 9, bl. 9
 sc. A, apt. 3
 RO-500338 Brasov
 Ph.: +40-268524459
 Fax: +40-268524459
 Email:info@assembla.ro
 http://www.assembla.ro

Russia
 VIPA Service Ltd
 Office 628, Dorozhnaja Str. 60B
 RU-117405 Moscow
 Ph: +7 499 608 1244
 Email: info@vipa.ru
 http://www.vipa.ru

Serbia
 Please contact
 VIPA Elektronik-Systeme GmbH,
 Austria

Slovakia
 Please contact
 REM-Technik s.r.o.,
 Czech Republic

Slovenia
 Please contact
 VIPA Elektronik-Systeme GmbH,
 Austria

Spain
 VIPA Automation, S.L.
 Avinguda Cerdanyola, 98
 Esc. B, 2a planta, local 6
 ES-08173 Sant Cugat del Valles
 Ul. Ostrowskiego 30
 PL-53238 Wroclaw
 Ph.: +34-93-583-1504
 Fax: +34-93-583-1782
 Email:vipa@vipa.es
 http://www.vipa.es
 http://www.speed7.es

Sweden
 Sensor Control Nordic AB
 Truckvägen 16B
 SE-194 52 Upplands Väsby
 Ph.: +46-8-668-2100
 Fax: +46-8-669-0110
 Email:info@scn.se
 http://www.scn.se

Switzerland
 SATOMEC AG
 Hinterbergstrasse 11
 CH-6330 Cham
 Ph.: +41-41-748-1777
 Fax: +41-41-748-1755
 Email:info@satomec.ch
 http://www.satomec.ch

Turkey
 OTEs Elektronik
 San. Ve Tic. Ltd. Sti.
 Aydinli Mah. Bilmo San. Sit. Yanyol Cad.
 Melodii Sokak No:11, Tuzla,
 TR 34953 Sekerpinar-Istanbul
 Ph.: +90-216-593-4800
 Fax: +90-216-593-4801
 Email: info@otes.com.tr
 http:// www.otes.com.tr

Ukraine
 SV Altera Ltd.
 Lepse ave. 4
 UA-03067 Kiev
 Ph.: +38-044-496-1888
 Fax: +38-044-496-1818
 Email:office@sv-altera.com
 http://www.svaltera.ua

AFRICA

Algeria
 Please contact
 VIPA FRANCE SAS, France

Morocco
 Please contact
 VIPA FRANCE SAS, France

South Africa
 Anytech (Pty) Ltd.
 Cnr. Orleans and Homestead
 ZA- Kya-Sand, Gauteng 2163
 Ph.: +27-11-708-1992
 Fax: +27-11-708-1745
 Email:info@anytech.co.za
 http://www.anytech.co.za

Tunesia
 Please contact
 VIPA FRANCE SAS, France

AUSTRALIA

Australia
 VIPA Automation
 2/41 Enterprise St
 AUS-Cleveland DC, QLD 4163
 Ph.: +61-7-3488-0177
 Fax: +61-7-3488-0144
 http://www.vipaautomation.com

New Zealand
 Please contact
 VIPA Automation, Australia

Pacific Islands
 Please contact
 VIPA Automation, Australia

AMERICA



Argentina
Exsol S.A.
Martin Coronado 925
Acassuso, 1641
AR-Buenos Aires
Ph.: +54-11-4742-9611
Fax: +54-11-4742-7118
Email: info@exsol.com.ar
http://www.exsol.com.ar



Brazil
Orkan Automation Ind.
Rua José Monteiro Filho, 486
Jardim Três Marias
BR-09750-140 Sao Bernardo
do Campo - SP
Ph.: +55-11-4125-6088
Fax: +55-11-4125-8811
Email: vendas@orkan.com.br
http://www.orkan.com.br



Canada
Please contact
VIPA USA, Inc.



Chile
Techvalue S.A.
Antonio Varas No. 894
Providencia
CL-Santiago-Chile
Ph.: +56-2-946-2584
Fax: +56-2-946-2582
Email: jfranco@techvalue.cl



Colombia
CIMATEC S EN C.
Carrera 46 No. 171-65
CO-Bogotá
Ph.: +57-1-477-5588
Email: gerencia@cimatec.com.co
servicios@cimatec.com.co
http://www.cimatec.com.co



Dominican Republic
Mando y Regulación Industrial
Santa Marta C/ 1ra, No.11, Nave #5
Zona Industrial de Manoguayabo
DO Santo Domingo R.D.
Ph.: +1-809-561-5025
E-Mail: mandoyreg.ind@claro.net.do



Ecuador
Iandcecontrol S.A.
General Duma N47-31
y Malvas (Monteserrin)
Quito
Ph.: +593-2-2257-587
Fax: +593-2-2275-471
Email: info@iandcecontrol.com
http://www.iandcecontrol.com



El Salvador
Matik S.A. de C.V.
Automatic Process Engineering
Colonia Escalón
Final Calle Arturo Ambrogi 7-A
SV San Salvador
Ph.: +503-2374-2063
Email:
francisco.majano@matik-ca.com



Mexico
Please contact
VIPA USA, Inc., USA



Peru
Automatización y Control
Industrial S.A.C.
Pasaje Loma d. Pilar 115, Of. 301
Santiago de Surco
PE-Lima 33
Ph.: +51-1-2780-105
Fax: +51-1-2780-205
Email: auto@autc.com.pe
http://www.autc.com.pe



Uruguay
ZyTECH Innovative Solutions
Cerro Largo 788 Bis.
UY-11000 Montevideo
Ph.: +598-2-901-3311
Fax: +598-2-901-3311
Email: info@zytech.com.uy
http://www.zytech.com.uy



USA
VIPA USA, Inc.
12600 Deerfield Pkwy. #100
US Alpharetta, GA 30004
Ph.: +1-678-880-6910
Fax: +1-770-234-5774
Email: info@vipa-usa.com
http://www.vipa-usa.com



Venezuela
Neumático Rotonda C.A.
Prolongación Av. Michelena
Centro Comercial Atlas
Local B-10 y B-11
VE Valencia Edo. Carabobo
Ph.: +58-241-832-6464
Fax: +58-241-832-6283
Email: ventas@neumaticar.com
http://www.neumaticar.com

ASIA



China, Headquarters
VIPA China, Beijing Office
Unit 709, Ronghua International
building 3,
10 South Ronghua Road
Yizhuang District
CN-100176 Beijing
Ph.: +86-10-855926-17/-18/-19
Fax: +86-10-85591678
Email: beijing@vipa.com.cn
http://www.vipa.com.cn

China, Branch Office
VIPA China, Shanghai Office
Room 601, Building 1
German Center,
Pudong District
No. 88 Keyuan Road
CN-201203 Shanghai
Ph.: +86-21-28986171
Fax: +86-21-28986170
Email: shanghai@vipa.com.cn
http://www.vipa.com.cn

China, Hong Kong
Ritech Engineering & Supply Co.
Ltd.
Units 1-2, 10/F South
China Industrial Bldg. No. 1.
Chun Pin Street, Kwai Chung, N.T.
Ph.: +852-2410-1819
Fax: +852-2410-1735
Email: sales@ritech-hk.com



India
VIPA Automation India Pvt Ltd.
B.R. House, 4th Floor
Hennur Main Road
IND-Bangalore 560043
Ph.: +91-80-2543-5757/58
Fax: +91-80-2543-5759
Email: info@vipaindia.com



Indonesia
Please contact
VIPA SDN BHD, Malaysia



Kazakhstan
Control Link LLP
Tolebi Street, house 302
Letter D, office 205
KZ-050000 Almaty
Ph.: +7-727-329-40-15
Email: info@controlink.kz



Korea
Yaskawa Electric Korea Co.,Ltd.
9F Kyobo Securities Bldg., 26-4,
Yeouido-dong, Yeongdeungpo-gu,
Seoul, Korea (150-737)
Ph.: +82-2-3688897
Fax: +82-2-7610447
E-mail: kslee@yaskawa.co.kr
http://www.yaskawa.co.kr/



Malaysia
VIPA GmbH (Regional Office SEA)
D-2-56, IOI Boulevard,
Jalan Kenari 5
MY-47170 Puchong,
Selangor
Ph.: +603-8076-5571
Fax: +603-8076-5491
Email: info@vipa.my



Pakistan
Pacific Engineering
147, Uni Shopping Centre
AH Road, Saddar
PK-74400 Karachi
Ph.: +92-21-566-1728
Fax: +92-21-566-0521
Email: pacific@pacificpk.com
http://www.pacificpk.com



Philippines
Please contact
VIPA SDN BHD, Malaysia



Singapore
Please contact
VIPA SDN BHD, Malaysia



Taiwan
Nano-Trend Technology Co., Ltd.
No. 365-6, Zhongshan Rd.
Sanxia Dist.
TW-237 New Taipei City
Ph.: +886-2-8671-9560
Fax: +886-2-8671-0084
Email: nt@nano-trend.com
http://www.nano-trend.com



Thailand
Navachot Innovation Co.,Ltd.
48/206 Soi Praditmanutham 19,
Praditmanutham Rd., Latphrao,
TH-10230 Bangkok
Ph.: +662-515-0186
Fax: +662-515-0187
Email: theerasak@navachot.com



Vietnam
Please contact
VIPA SDN BHD, Malaysia

MIDDLE EAST



Bahrain
Please contact Gulf-Tech
Automation, United Arab Emirates



Egypt
Middle East for Automation
System and Trading
37 Street 105
EL-Ethad Sq. 3/7
Maadi
EG Cairo
Ph: +2-02-252-428-42/43
Fax: +2-01-049-724-97
Email: info@masautomation.com
http://www.masautomation.com



Israel
C-Vision
Computer Systems Ltd.
Bareket 9
Northern Industrial Area
IL-38900 Caesarea
Ph.: +972-72-272-3000
Fax: +972-72-272-3001
Email: info@c-vision.co.il
http://www.c-vision.co.il



Jordan
Please contact Gulf-Tech
Automation, United Arab Emirates



Kuwait
Please contact Gulf-Tech
Automation, United Arab Emirates



Lebanon
I. Network Automation sal
United Assurance Bldg.
Ground Floor, Near Mercedes
Showroom, Dora Highway
Beirut, Lebanon
Ph.: +961-1-249-562
Fax: +961-1-249-563
Email: info@inetlb.com
http://www.inetlb.com



Oman
Please contact Gulf-Tech
Automation, United Arab Emirates



Qatar
Please contact Gulf-Tech
Automation, United Arab Emirates



Saudi Arabia
Please contact Gulf-Tech
Automation, United Arab Emirates



United Arab Emirates
Gulf-Tech Automation –
A GERMACS JTL Business
Unit No. 903, Tiffany Tower
Plot No. W2
Jumeirah Lakes Towers
Dubai
United Arab Emirates
Ph: +971 (0) 502-854-074
Email: sebastian@gulf-tech.com
http://www.gulf-tech.com



Yemen
Please contact Gulf-Tech
Automation, United Arab Emirates

Terms and conditions

General



The general supply and delivery terms are valid in their latest version (see next pages) as well as the addendum on extended retention of title. The prices are quoted in Euro (€) ex works, without insurance, freight and packaging. They do not include any VAT. Packaging cannot be returned. VAT will be indicated separately according to legal regulations and at the respective valid rate.

Minimum Order Value



The minimum value for each order amounts to € 150,- net. Orders with a value less than € 150,- will be charged with a handling fee of € 20,- to cover costs.

Dispatch and packing costs



Export sales:

Dispatch will be organized on ex works basis with a forwarding agent/courier service named by customer; alternatively freight cost will be calculated and charged according to weight and/or volume on the basis of VIPA Germany's freight rates at local partners..

Domestic sales:

Order value to 1.000 €	= 10,00 €
1.001 € - 2.500 €	= 1,00% of net price
2.501 € - 5.000 €	= 0,85% of net price
5.001 € - 7.500 €	= 0,65% of net price
7.501 € and higher	= all inclusive 57,00 €

Freight charges for bulky goods (e.g. 2 m of rails and cable drums) are calculated separately.

of sale and delivery

Validity



This price list is valid from 01.05.2014.
The price list may be subject to changes, especially as far as the values, dimensions and weights are concerned, if nothing different is noted explicitly.
The goods will be invoiced at the date of dispatch.

Manuals



When ordering modules, you will receive the corresponding customer documentation free of charge in PDF format on DVD. If you wish to receive hard copies of manuals, please order them separately.

The latest versions of all our manuals can be found on our homepage:
www.vipa.com -> Service -> manuals.
For further information please contact us:
Export sales: +49 (0)9132/744 - 1675 or -1670
Domestic sales: +49 (0)9132 / 744 - 1730
Homepage: <http://www.vipa.com>

Legend/Trademarks



MP2I = MPI + RS232
VIPA, SLIO, System 100V, System 200V, System 300V, System 300S, System 400V, System 500S and Commander Compact are registered trademarks of VIPA Gesellschaft für Visualisierung und Prozessautomatisierung mbH.
SPEED7 is a registered trademark of profichip GmbH.
SIMATIC, STEP, SINEC, S7-300 and S7-400 are registered trademarks of Siemens AG.
Microsoft und Windows are registered trademarks of Microsoft Inc., USA.
Portable Document Format (PDF) and Postscript are registered trademarks of Adobe Systems, Inc.
Zenon is a registered trademark of Copa Data GmbH.
All other trademarks, logos and service or product marks specified herein are owned by their respective companies.
Any liability for misprints or errors is excluded.
Availability and technical specifications are subject to change without notice.

General terms and conditions

1. General provisions

The following General Terms and Conditions of the Gesellschaft für Visualisierung und Prozessautomatisierung, hereinafter referred to as VIPA GmbH, shall apply for all present and future orders, deliveries and services (hereinafter referred to as: deliveries), unless expressly otherwise agreed by contract.

In case of deviations, supplements etc., we hereby expressly object to any conflicting or differing terms and conditions of contractual partners. We exclude all and any terms and conditions of contractual partners unless we expressly agree to them in writing.

2. Subject matter of the contract, scope of delivery, partial deliveries

- a) The offer and/or order confirmation of VIPA GmbH shall be decisive for the scope of delivery.
- b) Regarding cost estimates, drawings, wiring diagrams, samples, software source codes and other documentation, VIPA GmbH hereby retains its rights of ownership, copyrights and patent rights in their entirety. Such documents may only be made accessible to third parties with the prior written consent of VIPA GmbH. Drawings, wiring diagrams, samples, software source codes and other documentation that are part of the offer must be returned immediately on request in case the order is not awarded to VIPA GmbH. With regard to documents that were handed over to VIPA GmbH, the latter is entitled to make accessible such documents to third parties, as far as the company transfers services and deliveries to such third parties in a permissible way.
- c) VIPA GmbH is entitled to make partial deliveries, insofar as this is reasonable for the customer.

3. Prices and terms of payment, exclusion of set-off, cost estimates

- a) All the prices of VIPA GmbH are net prices quoted ex works, i.e. not including transport and packaging costs. All costs for delivery ex works, packaging, transport insurance etc. are invoiced separately. The same shall apply for the costs resulting from installation, erection and/or assembly, e.g. travel expenses. VAT will be charged separately. VIPA GmbH is entitled to charge a reminder fee of € 5.00 per reminder upon occurrence of a default.
- b) A set-off by the contractual partner is only permitted in case the outstanding claims are uncontested or established by final enforceable judgment. The same shall apply for any right of retention.
- c) Cost estimates shall be paid for.

4. Delivery period, deadlines, passing of risk

- a) Delivery dates and deadlines are not binding for VIPA GmbH unless it is agreed by contract that they are binding.
- b) The delivery time which was agreed upon shall be extended accordingly in the event of any circumstances beyond our control, which occur either in our own business or in that of a preliminary supplier. This applies in particular to strikes and lockouts as well as cases of force majeure which result from unforeseeable events or events over which the company and/or the preliminary suppliers have no control. VIPA GmbH undertakes to inform its contractual partners of any such delays as soon as they are foreseeable. If the performance of services by VIPA GmbH therefore becomes impossible or is seriously impaired, VIPA GmbH may cancel the contract wholly or in part. The customer is entitled to cancel the contract if VIPA GmbH does not perform the delivery after a written reminder until the end of a new appropriate deadline set by the customer. The compliance with expressly agreed delivery deadlines depends on the receipt in due time of all documents, necessary permits, clearances etc. which are to be supplied by the contractual partner, the clearance and approval of all plans in due time, as well as the compliance with the agreed terms of payment and other obligations by the contractual partner of VIPA GmbH. VIPA GmbH shall be entitled to exercise its right of retention despite a contractual delivery date in case due receivables from prior goods and services have not been settled by the contractual partner.
- c) The delivery deadline shall be considered met and the risk passes to the customer as soon as VIPA GmbH has handed over the item to the forwarding agent, the carrier or another person or institution responsible for dispatch or to the collector. If installation, erection or assembly is included in the scope of delivery, the risk shall pass and the delivery deadline shall be considered met on

the day of taking-over on the business premises of the contractual partner. If a test run was agreed, the latter shall be performed without delay after assembly and/or installation. If the dispatch, the assembly or installation/erection and/or the taking-over or a possible test run is delayed due to reasons for which the contractual partner is responsible or if a default of acceptance occurred, the risk shall pass to the contractual partner upon the start of delay caused by the contractual partner or upon occurrence of default of acceptance. This shall also apply for possible dispatches within the scope of replacement deliveries or after the performance of rectifications of defects by VIPA GmbH. The purchaser shall bear the risk for any reshipments effected by the customer to VIPA GmbH until the items of the reshipment are handed over in the premises of VIPA GmbH. Possible reshipments must always be free of carriage charges for VIPA GmbH.

5. Reservation of title

VIPA GmbH makes deliveries solely on the basis of the following reservation of title. This shall also apply to all future deliveries, even if VIPA GmbH does not make explicit reference to this.

- a) All deliveries / services are solely effected under reservation of title. VIPA GmbH shall remain the owner of the delivered goods until all accounts to which the company entitled from the customer as a result of the business relationship have been paid in full. The customer may neither pledge nor provide the goods as security to which we have retained ownership and it is also not allowed to resell such goods. The reseller is granted the revocable authorisation to resell such goods in the normal course of business, provided that its customers effect payment.
- b) As long as the ownership title has not been transferred, the customer shall be obliged to handle and stock the object of purchase with due care and to insure it at its own expense at replacement value against losses and damage from theft, fire and water. If any servicing or inspection work is required, the customer shall perform such work in due time at its own expense. As long as the ownership title has not been transferred, the customer shall be obliged to notify VIPA GmbH in writing as soon as possible in case the delivered item is pledged or is about to be pledged, retained or is threatened by execution or insolvency or is exposed to other third party interventions etc. In case of a compulsory execution or insolvency, the competent authorities must be informed about the ownership title of VIPA GmbH. The contractual partner shall be liable for damage resulting from neglect as well as for intervention expenses, if any. The expenses incurred by averting a seizure shall be borne by the customer. Where the third party is unable to reimburse the court and out-of-court expenses of a lawsuit pursuant to § 771 of the German Code of Civil Procedure (ZPO), the customer shall be liable for any loss incurred by VIPA GmbH.
- c) The customer shall be entitled to resell the goods subject to reservation of title in the normal course of business. The customer shall assign all purchase price and wage claims etc. arising from the resale of the goods subject to reservation of title to VIPA GmbH in the amount of the invoicing value including VAT. VIPA GmbH accepts this assignment. Such assignment shall be valid irrespective of the fact whether the goods were resold without or after processing. The customer shall be entitled to collect debts even after the assignment. The authority of VIPA GmbH to collect the debts itself shall not be affected by this. However, we undertake to refrain from collecting the claim as long as our contractual partner meets the payment obligations from the collected revenues, is not in delay of payment and, in particular, has not filed an application to open insolvency proceedings, and a cessation of payments does not exist.
- d) The processing, treatment or transformation of the purchased item shall always be made by the purchaser in the name and on behalf of VIPA GmbH. In this case, the customer shall continue to be eligible for the purchased item subsequent to processing or transformation. Should the purchased item be processed with other objects not belonging to VIPA GmbH, VIPA GmbH shall then acquire a joint ownership in the new item in the ratio of the value of the purchased item to the other processed objects at the time of processing. The same shall apply in the event of incorporation. If incorporation takes place in such a way that the customer's product is considered to be the main product, it is agreed that the customer shall transfer pro-rata joint ownership title to VIPA GmbH and shall safeguard on our behalf the sole title or joint title thereby arising. In order to secure the claims of VIPA GmbH against the customer, the latter shall assign to VIPA GmbH any claims that it acquires against a third party through the linking of the goods subject to reservation of title with a property. VIPA GmbH hereby accepts such assignment. VIPA GmbH undertakes to release the securities to which it is entitled, provided that their value exceeds the secured outstanding dues by more than 20%.

6. Claims for damages

- a) VIPA GmbH shall only assume liability if this is expressly agreed upon in writing or if an exclusion of liability is not permitted by law, e.g. in the event of willful intent or gross negligence or in case of harm to life, health and body or if the company is liable according to the Product Liability Act. Any other liability of VIPA GmbH, in particular claims for damages and reimbursement of expenses by the contractual partners, shall be excluded. Liability is also and particularly excluded in the case of non-performance or defective performance and for consequential losses or indirect damage. Liability of VIPA GmbH due to culpa in contrahendo shall be expressly excluded. VIPA GmbH hereby accepts this exclusion.
- b) Contractual penalties are not permissible unless expressly otherwise agreed in writing.

7. Limitation period, suspension of the limitation period

The limitation period for warranty claims and other claims against VIPA GmbH shall be twelve months. In case of shorter statutory limitation periods or shorter limitation periods agreed upon, such shorter limitation period shall apply. A shortening of the limitation period shall not be valid if this is excluded by law, in particular in case of fraudulent concealment of a defect. For deliveries to VIPA GmbH, the statutory limitation periods shall apply. The statutory regulations on suspension of statute of limitation, suspension of and restart of the limitation period shall not be affected by this. Settlement negotiations shall be deemed terminated in case VIPA GmbH does not respond in writing to a letter of the contractual partner after expiration of a period of 8 weeks.

8. Warranty

- a) A warranty beyond the statutory warranty regulations shall only be granted if such warranty is expressly stated in writing.
- b) The goods supplied by VIPA GmbH must be inspected immediately after handover. VIPA GmbH must be notified in writing immediately after receipt and/or inspection of the delivery of any defects, the lack of guaranteed qualities, transport damage, shortfall quantity, wrong deliveries etc and all processing or treatment works must be stopped immediately. Possible hidden defects must be communicated to us in writing as soon as they have been discovered. If such notification is not made in time, the delivery shall be deemed accepted. VIPA GmbH and the carrier must be notified in writing and without delay of any transport damage after receipt of goods. In case the notification of defects is justified and was made in time, VIPA GmbH shall be entitled to either rectify the defects, to effect a faultless replacement delivery and/or to render a faultless service. The contractual partner's right of reduction of the purchase price shall not be affected by unsuccessful rectification or cancellation of the contract.
- c) In case of the following, any warranty and/or any guarantee to which the company exceptionally consented in writing shall be excluded, unless the defect was fraudulently concealed:

Damage or losses resulting from faulty installation made by the customer or third parties or caused by improper use or fire, lightning strike, force majeure etc.

Repairs or repair attempts performed incorrectly or other interventions by the customers or other persons not authorised by VIPA GmbH

Damage caused by non-observance of the operating instructions or other instructions given by the staff of VIPA GmbH

Transport damage

Damage caused by the use of unsuitable or inferior replacement parts

Damage resulting from wear, humidity, strong heating of rooms or other effects of weather and temperature

Wear and tear parts

In case of negligible deviation from the agreed characteristics, in case of negligible impairment of serviceability or in case the model presents only minor deviations from the specifications in catalogues, advertising materials, samples etc.

Insufficient maintenance of the goods by the contractual partner

- d) No warranty is granted for second-hand goods supplied by VIPA GmbH. Second-hand goods are sold as seen.

- e) VIPA GmbH is entitled to claim compensation for the costs and expenses it incurred from the contractual partner in case the notification of defects was not justified. Claims from the purchaser towards VIPA GmbH for compensation of expenses, in particular transport costs and service assignments, due to supplementary performance, are excluded insofar as the expenses increase due to the fact that the object of delivery was subsequently carried to a place other than the agreed delivery address of the contractual partner.

- f) For any software, the conditions of the software licence of VIPA GmbH and of the software producer shall apply.

9. Impossibility of performance, adaptation of the contract

If it becomes impossible for VIPA GmbH to effect or provide the agreed delivery or service, the general legal principles shall apply as follows:

If the impossibility is the fault of VIPA GmbH, the contractual partner is entitled to make a claim for damages; however, such claim for damages of the purchaser shall be limited to 10% of the value of such part of the delivery or service that could not be used properly or put into service due to the impossibility of performance.

Any claims for damages exceeding the aforementioned 10% shall be excluded. This shall not apply in the event of willful intent or gross negligence, where liability is mandatory, or in case of harm to life, health and body.

The customer's right to withdraw from the contract shall not be affected by this.

In case unforeseeable events considerably modify the economic importance or the content of the delivery or service or affect the business operations of VIPA GmbH, the contract shall be adapted accordingly by VIPA GmbH, provided that this is compliant with the principles of good faith.

As far as this is not economically feasible, VIPA GmbH shall have the right to withdraw from the contract. When the company intends to make use of its right of withdrawal, it shall inform the purchaser of its intention as soon as the significance of the event will have fully come to its knowledge, i.e. also in such cases when an extension of the time of delivery was agreed with the purchaser.

10. Place of jurisdiction, place of performance, applicable law

- a) The sole local and international place of jurisdiction (if the contractual partner is a merchant) for all disputes arising directly or indirectly from the contract shall be the registered office of VIPA GmbH.
- b) The contractual relationship shall be subject to German substantive law only.
- c) The place of performance for deliveries and services of VIPA GmbH shall be the registered office of VIPA GmbH.

11. Authorisations, foreign countries

The contractual partner shall be responsible for and obtain official authorisations that may be required, in particular export licences. VIPA GmbH shall not be responsible or liable for possible official authorisations, in particular export licences, that may be required. The contractual partner is obliged to comply with all export provisions and export restrictions and all other provisions of the foreign trade legislations, in particular those of Germany, the EU and the EU member states, and to ensure that its contractual partners and third parties comply with these provisions as well. The contractual partner shall be obliged to make all required notifications, to provide all required information and to make all other necessary declarations to foreign authorities duly and completely.

The contractual partner shall pay all required customs duties, taxes or levies which may arise from a delivery into or the rendering of a service in a foreign country.

12. Other provisions, validity of the contract, authorisations

Should one or several provisions of the contract, including these General Terms and Conditions, be invalid, the validity of the contract or the General Terms and Conditions as a whole shall not be affected. In this case, the parties undertake to replace the invalid provision by a valid one which comes closest to the economic purpose of the invalid provision. The same shall be done in case of contractual gaps.

Changes and amendments to the contract must be effected in writing in order to be effective.

Notices

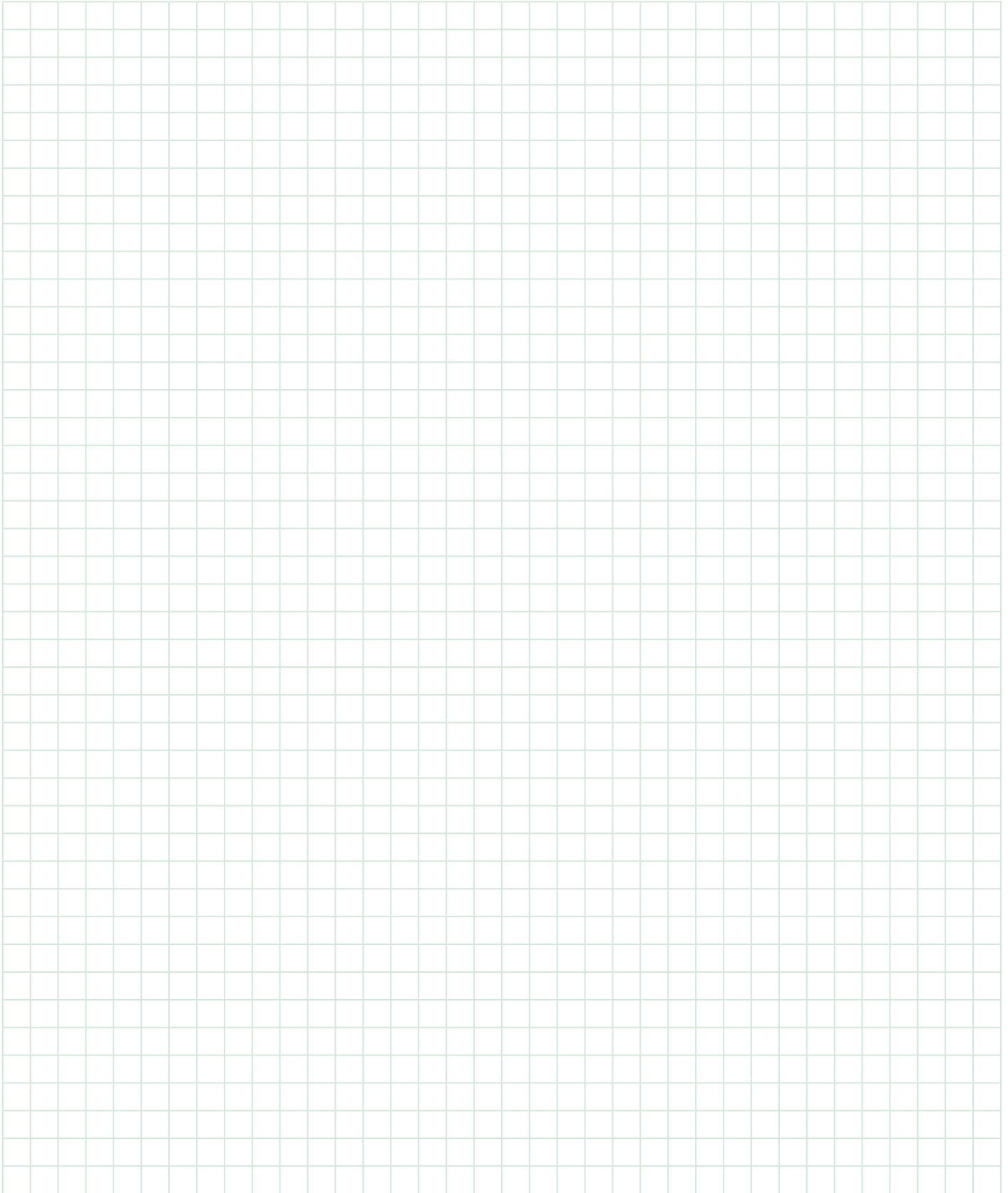

Water/
Sewage



Handling
Technology



Environment



Food & Beverage



Automotive



Renewable
Energy



Building
Technology



Packaging



VIPA worldwide

... in about 60 countries at home



VIPA GmbH
Ohmstr. 4
91074 Herzogenaurach
Germany
Tel.: +49-9132-744-0
Fax: +49-9132-744-1864
www.vipa.com